

# Makro-Planar T\* 2/50 ZF

## The Speed Macro

- Fastest 50 mm macro lens for the 24 x 36 full frame
- Very high image quality over the entire focusing range from infinity to the close-focus limit at half life-size
- Optical system with “floating element” and longlife full metal precision mechanics

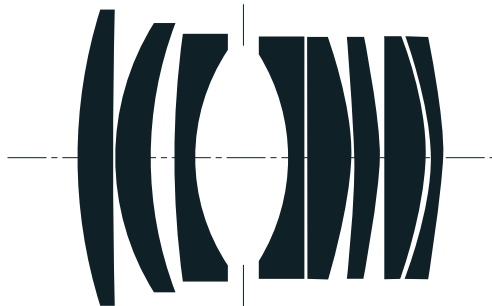
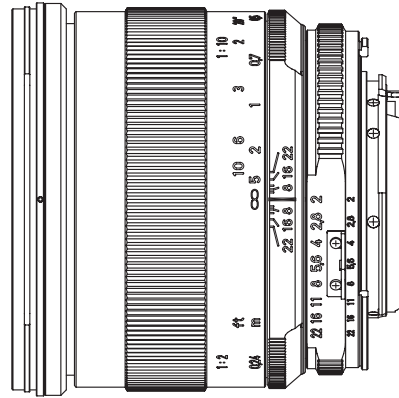

## Technical Specifications

**Focal length:** 51.6 mm

**Aperture range:** f/2.0 – f/22 (1/2 stop intervals)

**Number of elements/groups:** 8/6

**Focusing range:** 0.24 m – ∞

**Angular field, diag./horiz.:** 45.5°/38.5°

**Coverage at close range:** 48 x 72 mm

**Image ratio at close range:** 1:2

**Filter thread:** M67 x 0.75

**Dimensions:** ø 72 mm, length 65 mm

**Weight:** 530 g

Subject to change.

Carl Zeiss AG

**Distribution in the UK**

**Lambda**  
photometrics

**Lambda Photometrics Ltd**, Lambda House, Batford Mill, Harpenden, Hertfordshire AL5 5BZ

**E:** [info@lambdaphoto.co.uk](mailto:info@lambdaphoto.co.uk) **W:** [www.lambdaphoto.co.uk](http://www.lambdaphoto.co.uk) **T:** +44 (0)1582 764334 **F:** +44 (0)1582 712084

The leading supplier of scientific and industrial lasers, optical systems and associated accessories, fibre optic components and instrumentation, and machine vision products.



We make it visible.

# Makro-Planar T\* 2/50 ZF

## Performance data

The Modulation Transfer (MTF) as a function of image height (u) and slit orientation (sagittal, tangential) has been measured with white light at spatial frequencies of R = 10, 20 and 40 cycles/mm.

MTF [%], f-number: k = 4.0 Image ratio 1:10

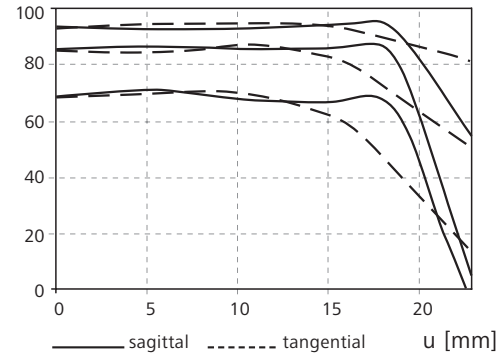

E [%], Relative illuminance

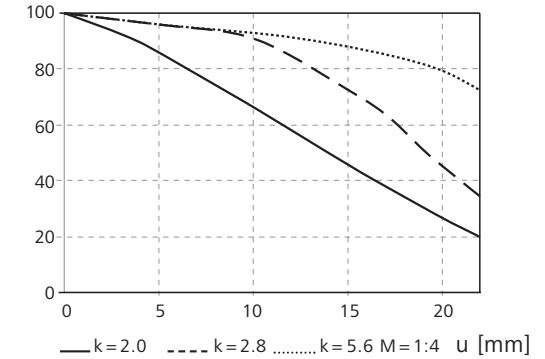

MTF [%], f-number: k = 4.0 Image ratio 1:5

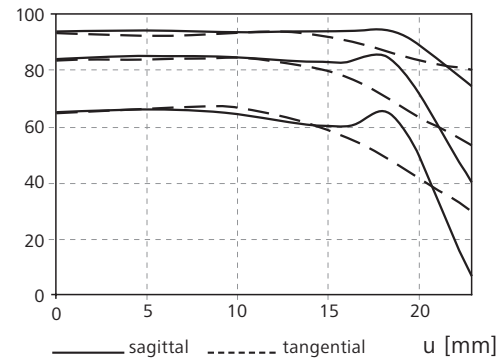

V Distortion in % of image height

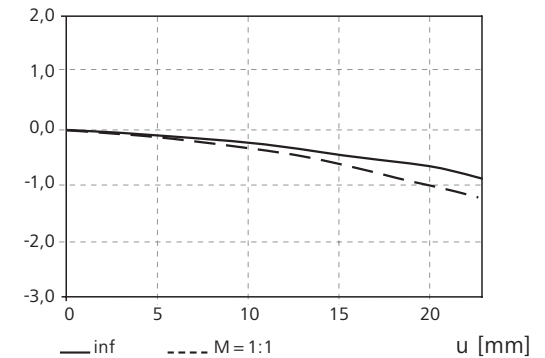

Subject to change.

Carl Zeiss AG

Distribution in the UK



Lambda Photometrics Ltd, Lambda House, Batford Mill, Harpenden, Hertfordshire AL5 5BZ

E: [info@lambdaphoto.co.uk](mailto:info@lambdaphoto.co.uk) W: [www.lambdaphoto.co.uk](http://www.lambdaphoto.co.uk) T: +44 (0)1582 764334 F: +44 (0)1582 712084

The leading supplier of scientific and industrial lasers, optical systems and associated accessories, fibre optic components and instrumentation, and machine vision products.



We make it visible.

# Makro-Planar T\* 2/50 ZF

## Performance data

The Modulation Transfer (MTF) as a function of image height (u) and slit orientation (sagittal, tangential) has been measured with white light at spatial frequencies of R = 10, 20 and 40 cycles/mm.

MTF [%], f-number: k = 2.0

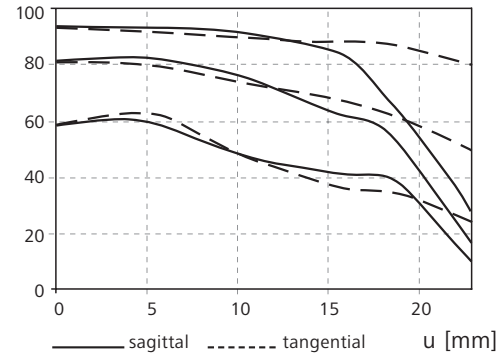

MTF [%] , f-number: k = 5.6

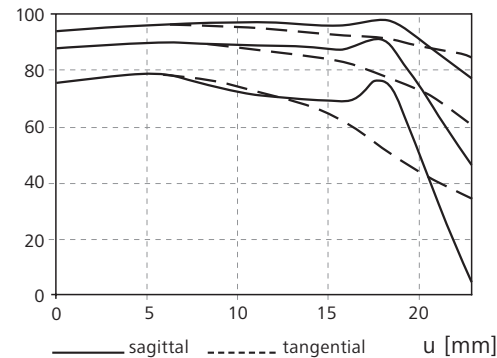

Subject to change.

Carl Zeiss AG

Distribution in the UK

**Lambda**  
photometrics

Lambda Photometrics Ltd, Lambda House, Batford Mill, Harpenden, Hertfordshire AL5 5BZ

E: [info@lambdaphoto.co.uk](mailto:info@lambdaphoto.co.uk) W: [www.lambdaphoto.co.uk](http://www.lambdaphoto.co.uk) T: +44 (0)1582 764334 F: +44 (0)1582 712084

The leading supplier of scientific and industrial lasers, optical systems and associated accessories, fibre optic components and instrumentation, and machine vision products.



We make it visible.