

Oscilloscope Reference Manual CS300



Cleverscope Models:

| | |
|-----------|-----------|
| CS320 | CS328 |
| CS320A | CS328A |
| CS320AE | CS328AE |
| CS320A-XS | CS320-XSE |

Table of Contents

| | | |
|----------|---|-----------|
| 1 | SAFETY | 10 |
| 2 | OVERVIEW | 11 |
| 3 | GETTING STARTED..... | 14 |
| 3.1 | Unpack..... | 14 |
| 3.2 | Install Cleverscope Application Software..... | 14 |
| 3.3 | Power up the Cleverscope Acquisition Unit (CAU) | 14 |
| 3.4 | Connect the CAU to the PC - USB | 14 |
| 3.5 | Connect the CAU to the PC - Ethernet..... | 14 |
| 3.6 | Acquire a Signal for Display | 15 |
| 3.7 | Compensate Probes..... | 17 |
| 3.8 | Changing the Trigger Edge..... | 18 |
| 3.9 | Setting Trigger Level | 18 |
| 3.10 | Adjusting the Scope Display | 19 |
| 3.11 | Signal Generators | 20 |
| 3.12 | Keyboard Shortcuts – Quick Reference..... | 21 |
| 4 | CLEVERSCOPE CONTROL PANEL..... | 22 |
| 4.1 | Cleverscope Tools Zone [Control Panel] | 22 |
| 4.2 | ACQUIRE Zone [Control Panel]..... | 24 |
| 4.3 | DISPLAY Zone [Control Panel]..... | 27 |
| 4.4 | TRIGGER 1 Zone [Control Panel]..... | 29 |
| 4.5 | Trigger 2 Settings (Ctrl+T) [Control Panel]..... | 30 |
| 4.6 | Trigger 1~2 Zone [Control Panel] | 31 |
| 4.7 | Digital Pattern Triggering Zone [Control Panel]..... | 32 |
| 4.8 | Decode Protocol zone [Control Panel]..... | 32 |
| 5 | CONTROL PANEL - MENUS | 33 |
| 5.1 | File Menu [Control Panel]..... | 34 |

| | | |
|-----------|---|-----------|
| 5.2 | Edit Menu [Control Panel]..... | 39 |
| 5.3 | Settings Menu [Control Panel] | 39 |
| 5.4 | View Menu [Control Panel] | 58 |
| 5.5 | Window Menu [Control Panel]..... | 59 |
| 5.6 | Help Menu [Control Panel]..... | 59 |
| 6 | SCOPE DISPLAY [VIEW MENU] | 60 |
| 7 | TRACKING DISPLAY [VIEW MENU]..... | 61 |
| 7.1 | How the Tracking Display Works | 61 |
| 8 | SPECTRUM DISPLAY [VIEW MENU]..... | 62 |
| 8.1 | Spectrum Display Tracer and Markers | 63 |
| 9 | CLEVERSCOPE DISPLAYS – DISPLAY CONTROL BUTTONS | 64 |
| 9.1 | Display Buttons - Vertical Axis..... | 64 |
| 9.2 | Zooming the Graph | 66 |
| 10 | CLEVERSCOPE DISPLAYS - TRACERS AND MARKERS | 67 |
| 10.1 | Tracers | 67 |
| 10.2 | Setting Analog Markers | 67 |
| 10.3 | Digital Tracers and Markers | 68 |
| 10.4 | Setting Digital Markers | 68 |
| 10.5 | Using Markers to Measure Differences and Frequency | 69 |
| 10.6 | Cleverscope Displays - Frame and Trigger Time Stamp..... | 69 |
| 10.7 | Cleverscope Displays - Graph Tools..... | 69 |
| 11 | PERSISTENCE | 71 |
| 11.1 | Example Plots | 72 |
| 11.2 | Persistence Plots | 73 |
| 11.3 | Eye-diagram Plots | 74 |
| 11.4 | Performance | 74 |
| 11.5 | Conclusion | 74 |

| | |
|--|-----------|
| 12 STREAMING | 75 |
| 12.1 Capturing a Stream | 75 |
| 12.2 Reviewing the Stream | 77 |
| 12.3 Protocol decoding a stream | 79 |
| 12.4 Tracking and Maths Display of a Stream | 80 |
| 12.5 Spectrum Display of a Stream | 81 |
| 12.6 Open a Stream File | 81 |
| 13 SIGNAL INFORMATION [VIEW MENU] | 82 |
| 13.1 Signal Information Display | 82 |
| 13.2 Signal Information – Show Logging Button (Scope source) | 82 |
| 13.3 Signal Information – Waveform Functions (Scope Source) | 83 |
| 13.4 Signal Information – Pulse Functions (Scope source) | 84 |
| 13.5 Signal Information Display – Spectrum Functions (Spectrum source) | 85 |
| 13.6 Signal Information Display – Spectrum FRA Functions (Spectrum source) | 85 |
| 13.7 Dynamic Data Exchange (DDE) | 86 |
| 13.8 Using Logging | 87 |
| 14 XY DISPLAY [VIEW MENU] | 88 |
| 14.1 XY Display Controls | 88 |
| 14.2 Using the X-Y Display | 88 |
| 14.3 Digital Inputs [View Menu] | 89 |
| 15 TRIGGER 2 SETTINGS [VIEW MENU] | 90 |
| 16 CS700A SIGNAL GENERATOR MODULE CONTROLS [VIEW MENU] | 91 |
| 16.1 Using the CS700A Signal Generator Module | 94 |
| 16.2 Connect and Set Up | 94 |
| 16.3 Acquire the Signal Generator Output | 95 |
| 17 FREQUENCY RESPONSE ANALYSER FRA [VIEW MENU] | 96 |
| 17.1 Where to next? | 97 |
| 17.2 Connections | 97 |

| | | |
|-----------|--|------------|
| 17.3 | Use of the FRA with Power Supplies..... | 98 |
| 17.4 | Getting Started with the FRA | 101 |
| 17.5 | Frequency Response Analyser Control Window..... | 102 |
| 18 | SIGNAL GENERATOR SIMULATOR [VIEW MENU]..... | 122 |
| 18.1 | Signal Generator Simulator Control Window | 122 |
| 18.2 | Using the Signal Generator Simulator | 123 |
| 19 | MATHS DISPLAY [VIEW MENU] | 124 |
| 19.1 | Maths Display..... | 124 |
| 19.2 | Maths Equation Builder | 124 |
| 19.3 | Maths Equation Builder Walkthrough..... | 129 |
| 19.4 | Example - Power Consumption [Maths]..... | 129 |
| 19.5 | Example - Deriving the Differential Voltage [Maths]..... | 130 |
| 19.6 | Example - Deriving Current [Maths]..... | 130 |
| 19.7 | Example - Deriving Power [Maths]..... | 131 |
| 19.8 | Example - Deriving Energy [Maths] | 133 |
| 20 | MATLAB USAGE | 134 |
| 20.1 | Matlab .m functions..... | 134 |
| 20.2 | Setting up a Cleverscope for Matlab | 135 |
| 20.3 | Matlab Functions - Example 1 Add two channels..... | 136 |
| 20.4 | Matlab Functions - Example 2..... | 137 |
| 20.5 | Matlab Functions - Example 3..... | 137 |
| 20.6 | Matlab Functions - Example 4..... | 138 |
| 20.7 | Using Matlab for Further Processing..... | 139 |
| 20.8 | Conclusion | 139 |
| 21 | PROTOCOL SETUP | 140 |
| 21.1 | UART Tab | 141 |
| 21.2 | SPI Tab | 142 |
| 21.3 | I2C Tab..... | 143 |

| | | |
|-----------|--|------------|
| 21.4 | Count Tab..... | 144 |
| 21.5 | Using the Protocol Decoder..... | 145 |
| 21.6 | Using the Protocol Decoder - Additional Notes..... | 146 |
| 21.7 | I ² C protocol Example..... | 146 |
| 21.8 | UART Protocol Example..... | 149 |
| 21.9 | SPI Protocol Example..... | 150 |
| 22 | NOTES [VIEW MENU]..... | 151 |
| 23 | USING THE ETHERNET CLEVERSCOPE..... | 152 |
| 23.1 | Using Cleverscope on a DHCP Network..... | 152 |
| 23.2 | Using Cleverscope on a Fixed IP Network or Direct Connected to a PC..... | 156 |
| 23.3 | Remote Fixed IP Network..... | 159 |
| 24 | 4-CHANNEL CLEVERSCOPE..... | 160 |
| 24.1 | Binary Version..... | 160 |
| 24.2 | USB Serial Numbers..... | 160 |
| 24.3 | Program USB Serial Number..... | 161 |
| 24.4 | Connect the Units..... | 161 |
| 24.5 | Ready the Cleverscope4 Application..... | 161 |
| 24.6 | Run the Cleverscope4 Application..... | 162 |
| 25 | UPDATING CLEVERSCOPE..... | 164 |
| 25.1 | Important – Read Before Starting..... | 164 |
| 25.2 | Cleverscope Application Software First Time Installation..... | 164 |
| 25.3 | Updating Cleverscope..... | 164 |
| 25.4 | Important – Before Updating..... | 165 |
| 25.5 | Update an existing Cleverscope Application..... | 165 |
| 25.6 | Using the Cleverscope Application with a Classic CS320/8..... | 168 |
| 25.7 | Updating Cleverscope Applications Prior to 6430..... | 168 |
| 25.8 | Firmware Update..... | 169 |
| 25.9 | Ethernet Cleverscope Firmware Update..... | 170 |

25.10 Update a First Generation Installation 170

25.11 Using Windows 98SE, ME and NT..... 170

26 CALIBRATE CLEVERSCOPE (VERSIONS 6442+)..... 171

26.1 Calibration Functions..... 171

26.2 Once Yearly Calibration 171

26.3 Standard Calibration..... 172

26.4 Signal Generator Calibration 172

26.5 Digital Inputs Calibration 174

26.6 Frequency Response Calibration..... 174

26.7 Ext Trig Calibration 175

27 CLEVERSCOPE SUPPORT 176

27.1 Minimum PC Requirements 176

27.2 Evaluation Software 176

28 CLEVERSCOPE SPECIFICATION..... 179

28.1 Signal Acquisition 179

28.2 Analog Inputs 179

28.3 Vertical..... 179

28.4 Horizontal..... 180

28.5 Triggering..... 180

28.6 Digital Inputs (CS328A) 180

28.7 Measurements 180

28.8 PC Interface 181

28.9 Calibration..... 181

28.10 Displays..... 181

28.11 Mathematical Functions 182

28.12 Spectrum Analysis 182

28.13 Protocol Decode..... 182

28.14 Charting..... 183

28.15 Data Export 183

| | | |
|--------------|--|------------|
| 28.16 | Windows Facilities | 183 |
| 28.17 | Probe Compensator Output..... | 183 |
| 28.18 | Power Source..... | 183 |
| 28.19 | Environmental..... | 183 |
| 28.20 | Mechanical..... | 184 |
| 28.21 | Expansion Capability - Signal Generator Module CS700A | 184 |
| 28.22 | Expansion Capability – Increase Sampling Channels and Sample Rate | 184 |
| 28.23 | Cleverscope Hardware Resources | 185 |
| 28.24 | Cleverscope Application Software Resources: | 185 |
| 29 | APPENDIX 1 – DOCUMENT CONTROL..... | 186 |
| 30 | APPENDIX 2 - KEYBOARD SHORTCUTS | 188 |

1 Safety

Please review the following safety precautions to avoid injury and prevent damage to this product or any products connected to it.

To avoid potential hazards, use this product only as specified.

Only qualified personnel should perform service procedures.

To Avoid Fire or Personal Injury:

Use Proper Power Adapter. Use only the power adapter specified for this product and certified for the country of use.

Connect and Disconnect Properly. Do not connect or disconnect probes or test leads while they are connected to a voltage source.

Connect and Disconnect Properly. De-energize the circuit under test before connecting or disconnecting the current probe.

Ground the Product. This product is grounded through the grounding conductor of the power cord. To avoid electric shock, the grounding conductor must be connected to earth ground. Before making connections to the input or output terminals of the product, ensure that the product is properly grounded.

Observe All Terminal Ratings. To avoid fire or shock hazard, observe all ratings and markings on the product. Consult the product manual for further ratings information before making connections to the product.

The inputs are not rated for connection to mains or Category II, III, or IV circuits.

Connect the probe reference lead to earth ground only.

Do not apply a potential to any terminal, including the common terminal, that exceeds the maximum rating of that terminal.

Power Disconnect. Power adapter disconnection disconnects the product from the power source. Do not block the power connection; it must remain accessible to the user at all times.

Do Not Operate Without Covers. Do not operate this product with covers or panels removed.

Do Not Operate With Suspected Failures. If you suspect that there is damage to this product, have it inspected by qualified service personnel.

Avoid Exposed Circuitry. Do not touch exposed connections and components when power is present.

Do Not Operate in Wet/Damp Conditions.

Do Not Operate in an Explosive Atmosphere.

Keep Product Surfaces Clean and Dry.

Provide Proper Ventilation. Ensure the unit has adequate ventilation so the ambient temperature does not exceed 40 deg. C.

2 Overview

The **Cleverscope** is a PC based mixed signal oscilloscope, spectrum analyser, and signal generator. Signals are captured by the Cleverscope Acquisition Unit that connects via USB or Ethernet connection to a local PC. Software in the PC provides a significant functionality not normally unavailable from traditional stand-alone oscilloscopes.

The Scope display is the main window and, as shown below, contains the normal waveform display together with an information panel, plus the option for displaying up to 8 digital inputs.

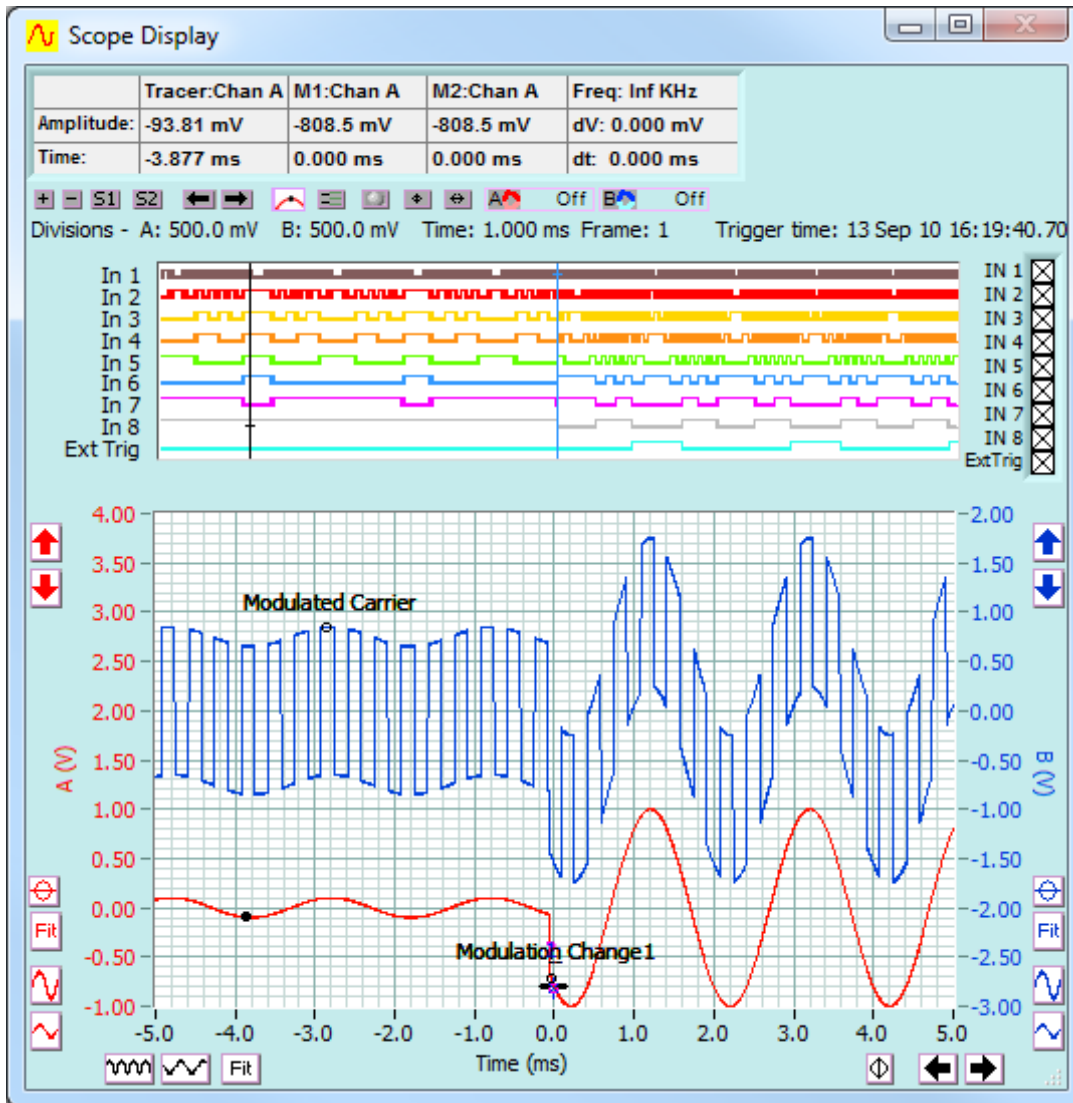

On-screen controls allow the display to be adjusted as required. Tracers are provided to facilitate detailed measurements.

Cleverscope functionality is resident on the PC. The Cleverscope Application Software implements several different oscilloscope displays, signal generator controls, spectrum analyser, digital logic analyser, protocol analyser, Matlab functionality, and copy and paste facilities for documentation of test results. Graphs and data can be copied and pasted to other applications, saved or loaded from disk, and printed.

A full technical specification is included at the end of this manual.

Cleverscope

Cleverscope has been designing and manufacturing test equipment since 2004. The company is based in Auckland, New Zealand.

Circuit boards are assembled in a modern RoHS compliant ISO9002 certified manufacturing facility, also in Auckland.

The RoHS Compliance Statement is available at www.cleverscope.com.

Both Cleverscope models have been tested to comply with CE directives on Electromagnetic Compatibility (89/336/EEC) and Low Voltage (73/23/EEC).

Cleverscope Models

All Models have 2 Analog Channels, External trigger Input, Cleverscope Application Software, a dual channel sampler and an interface to the PC.

Cleverscopes are also available in OEM configurations and quantities for embedded applications.

Orders can be placed online via the web site or sent via email or purchased through distributors. Distributors are listed on the web site.

All Cleverscopes come with a three year warranty from date of manufacture. There is also a Money Back Guarantee, details of which are on the web site.

USB 2.0 Interface (CS740) Models

- | | |
|-----------|---|
| CS320A | 4M Samples, 10 bit sampler, USB I/O The CS320A can be upgraded to 8M memory, 12 or 14 bit dual channel sampler, plus signal generator. |
| CS328A | 4M Samples, 10 bit sampler, 8 digital inputs, USB I/O The CS328 can be upgraded to 8M memory and 12 or 14 bit dual channel sampler, plus signal generator. |
| CS328A-XS | 8M Samples, 14 bit sampler, 8 digital inputs, USB I/O, CS700 Signal Generator |

Ethernet (Isolated) (CS741) Models

- | | |
|------------|---|
| CS320AE | 4M Samples, 10 bit sampler, Ethernet I/O The CS320AE can be upgraded to 8M memory and 12 or 14 bit dual channel sampler plus signal generator. |
| CS328AE | 4M Samples, 10 bit sampler, 8 digital inputs, Ethernet I/O The CS328AE can be upgraded to 8M memory and 12 or 14 bit dual channel sampler plus signal generator. |
| CS328A-XSE | 8M Samples, 14 bit sampler, 8 digital inputs, Ethernet I/O, CS700 Signal Generator |

Modules

| | |
|--------|---|
| CS800 | Upgrade to 8MSample memory |
| CS810 | External Sampler Clock Interface |
| CS710 | 100MHz 10 bit dual channel sampler |
| CS712 | 100MHz 12 bit dual channel sampler |
| CS714 | 100MHz 14 bit dual channel sampler |
| CS740 | USB 2.0 PC Interface module |
| CS741 | Ethernet Interface module |
| CS700A | Signal Generator (0 – 10 MHz, Sine, Square, Triangle) |
| CS701 | Sine Wave Generator 300Vrms isolated (0 – 65MHz, sine) |
| CS1070 | Power Amplifier, stand-alone. 50 MHz Bandwidth, 1A drive current, +/-17V output sine wave or DC value (using supplied 19V supply) which maybe offset from 0V to +17V by using a higher voltage input supply (20V - 36V). With a 36V supply the output swings 0 - 34V. |

Accessories

| | |
|--------|--|
| CS1001 | Analog Probe - 1x, 10x 250MHz |
| CS1002 | Analog Probe – 100x 250MHz |
| CS1003 | Analog Probe - 1000x, 50MHz |
| CS1004 | Digital Probe Pod – 4bit 100MHz (including probe clips) Colour-coded ports 1-4 |
| CS1004 | Digital Probe Pod – 4bit 100MHz (including probe clips) Colour-coded ports 5-8 |
| CS1010 | 50 5ns delay line to connect Channel A to Channel B for 200MSample operation |
| CS1020 | 2 port link cable to connect two Cleverscope units for four channel operation |
| CS1030 | Differential Probe 25MHz 1300v |
| CS1031 | Differential Probe 50MHz 6500v |
| CS1041 | USB Isolator |
| CS1050 | Power Supply without 230/110v cable |
| CS1060 | 70Amp AD Dc current Probe |

Probe sets come complete with the probe tip accessories, compensation adjusting tool, and channel Identifying clips. Each probe packet includes a frequency response chart.

Upgrades

Upgrades are normally specified at time of ordering and supplied installed ex-factory.

Some modules can be retro-fitted in the field by qualified personnel using antistatic facilities and appropriate tools. Full instructions are provided by Cleverscope.

Configurations

Cleverscopes are defined by their configuration ID in the form of mem.sps.bit.sig.io where

| | | |
|-----|---------------|--|
| mem | 4 or 8 | 4MSamples or 8MSamples |
| sps | 10 | Speed in 10MSPS unit, 100MSPS = 10 |
| bit | 10, 12, or 14 | Number of sampler bits |
| sig | 0 or 1 | 0 not fitted, 1 CS700A fitted 2 701 fitted |
| io | 1 or 2 | 1 USB, 2 Ethernet |

3 Getting Started

The Cleverscope is easy to set up and get running once the Cleverscope application software is installed on your PC.

3.1 Unpack

Cleverscopes are normally supplied as a boxed kit containing the Cleverscope Acquisition Unit, power supply and power cable, two 1x/10x 250MHz probes, installation Instructions, a Cleverscope Application Software CDROM, and digital probe sets for the digital versions.

Unpack the box, remove wrapping and discard safely.

3.2 Install Cleverscope Application Software

The Cleverscope Application Software is supplied on the CD that came with the unit. Install the software by following the instructions on the printed sheet. Do not plug in the Cleverscope while installing the software.

Minimum requirements are a Pentium PC with at least 256 MB of memory running Windows 7, Windows Vista, Windows XP or Windows 2000.

3.3 Power up the Cleverscope Acquisition Unit (CAU)

Connect the **DC power cable** to *POWER IN*, socket on the rear panel.

Note: When you plug the power adapter into the mains the Trig indicator should blink and the Power indicator should show a steady green. This is the self test completing.

Plug the **power adaptor** into the mains. Observe the green power light.

3.4 Connect the CAU to the PC - USB

Connect the **USB cable** to *USB* port on the rear of the unit and to the PC.

Note If this is the first time of use, there will be a small delay while Windows finds the drivers.

3.5 Connect the CAU to the PC - Ethernet

For an Ethernet CAU connect the Ethernet cable to the Ethernet port on the rear of the unit and to the PC/switch/network.

Check the indicator lights on the Ethernet port are illuminated.

3.6 Acquire a Signal for Display

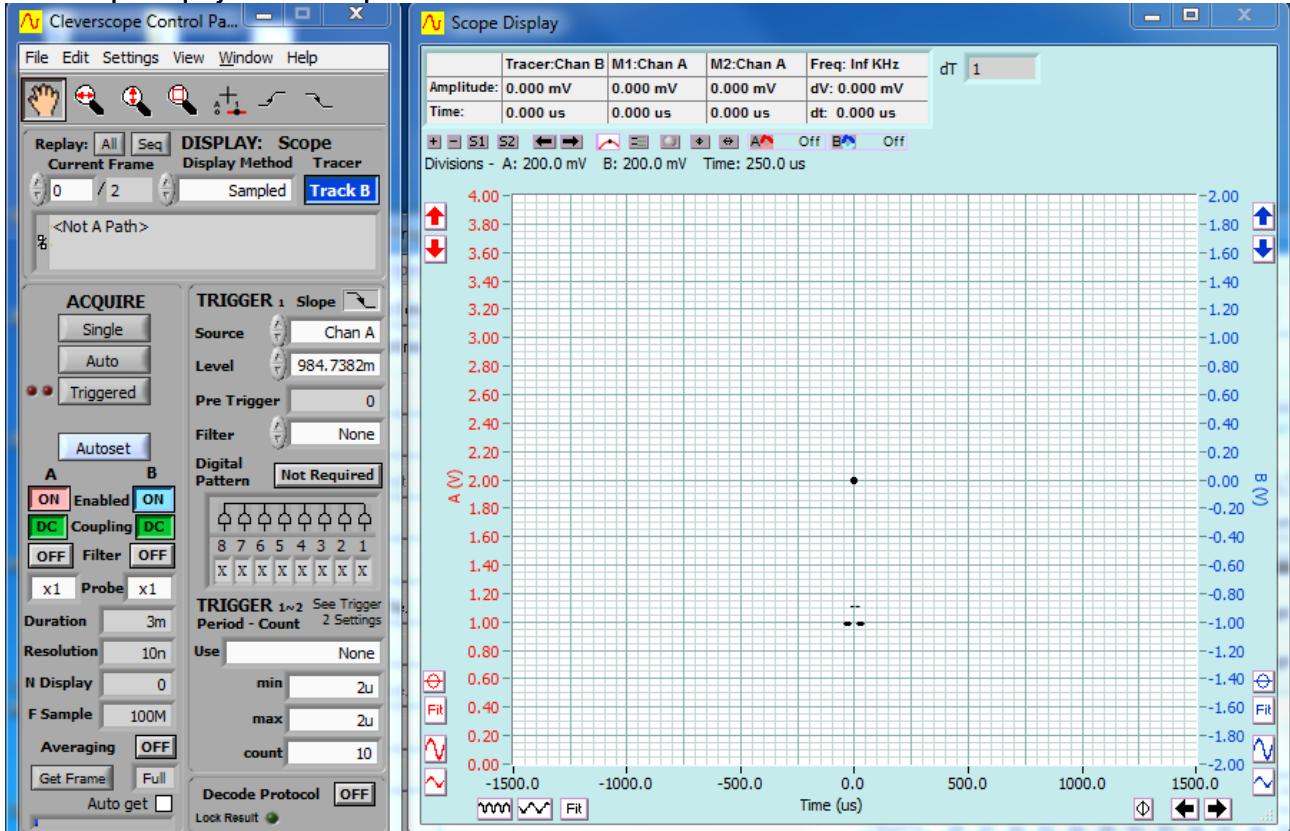

Start the Cleverscope application software on the PC.

Cleverscope Displays on Start-up

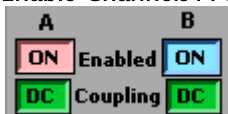

Enable Channels A & B On the **Cleverscope Control Panel**



Click the **Enabled** buttons for both channel **A** and **B** so that they both display 
 Click the Coupling buttons for both channel **A** and **B** so that they both display 

Probe Attenuation



Check the probe attenuation are both set to **x1**.

Connect probes to Chan A and Chan B and, using the clip accessory, clip the probe tips to the Probe Comp pin on the CAU front panel, the leftmost of the two pins.

Note: Probe Comp produces a 2v p-p square wave signal for probe frequency response compensation.

Clip the earth clips to the earth pin, the rightmost of the two pins.

Check the probe attenuation slider switch on the probe barrel is set to x1.

Autoset

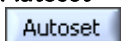

Click to automatically scale the Scope Display and automatically set the trigger settings to match the signal you have connected.
 Autoset may take a few moments to acquire the signal and work out the correct display settings.

The result should be similar to the following:

Start-up First Capture

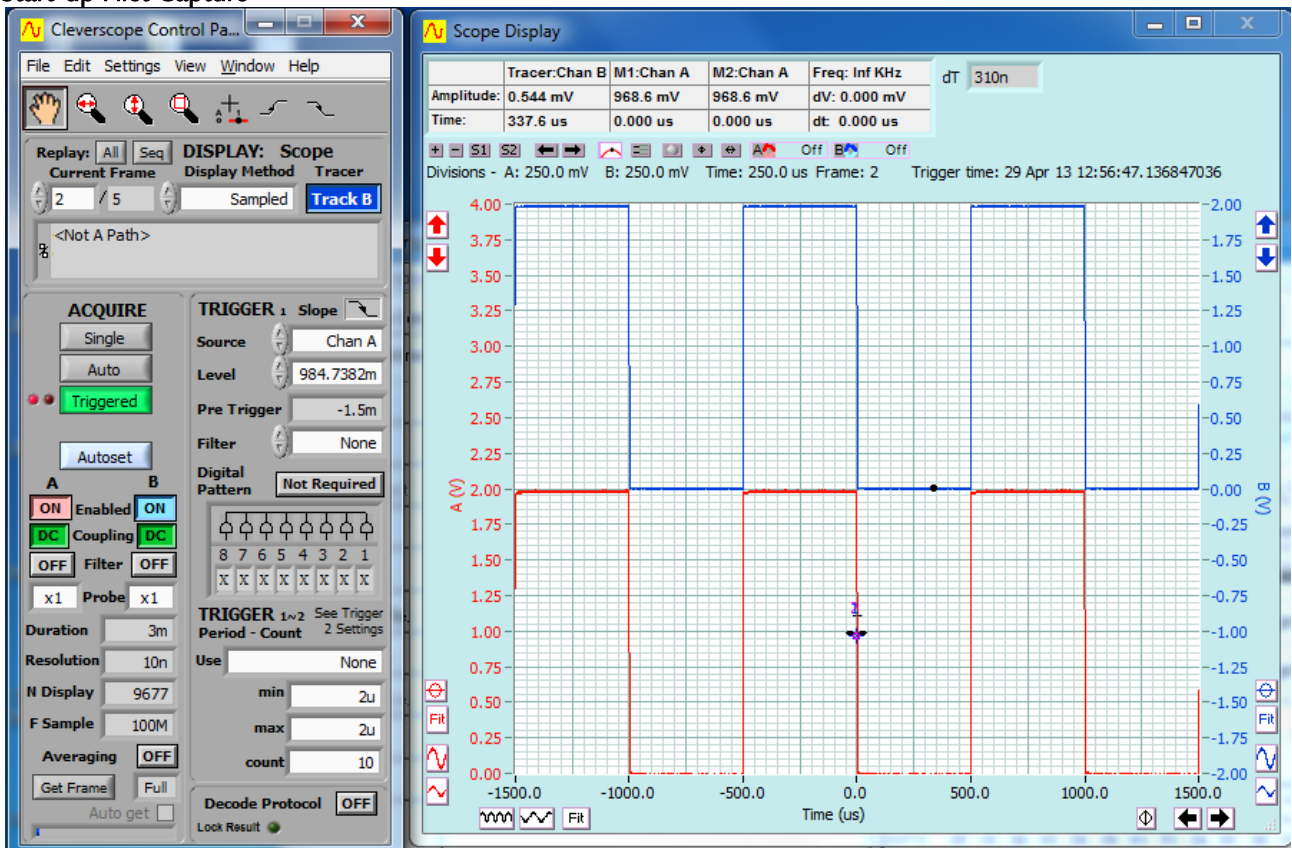

- Channel A is displayed in the lower half of the Scope display and is coloured red. The axis for channel A is on the left.
- Channel B is displayed on the upper half of the Scope display and coloured blue. Channel B axis is on the Right.
- Y-Axis Note both channels are referenced to ground (0 volts) in their respective scales.
- X-Axis Both displays are shown on a common time axis with '0' in the middle of the graph. Times to the left of '0.0' are before trigger and time after '0.0' post trigger.
- Triggering The graph above shows the acquisition has triggered on the falling edge of channel A at a trigger level of about 1V (984.7382m displayed in the Trigger 1 Level field).



3.7 Compensate Probes

This is a good time to compensate your probes.



Go to the Cleverscope **Control Panel** window.

In the **ACQUIRE** area, set the **Probe** attenuation to *x10*.

In the **TRIGGER** area, set the trigger **Level** to *1V*.

You should be already viewing the **Scope** display.

If not the select the **Scope** display window from the Control Panel **Window** menu.

Set the A channel graph axis to include the voltage range 0 to 4V.

Set the time axis to include the range $-750 \mu\text{s}$ to $+750 \mu\text{s}$.

Plug the scope probe into the A channel, attach the hook probe tip.

Set the probe switch (on the barrel of the probe) to *x10*.

Connect the ground crocodile clip to the right hand ground terminal.

Connect the probe to the left hand Probe Comp output terminal.

Go to the Cleverscope **Control Panel** window.

Click **Triggered** button and you should see a graph similar to that on the left.
 <<<<

Triggered

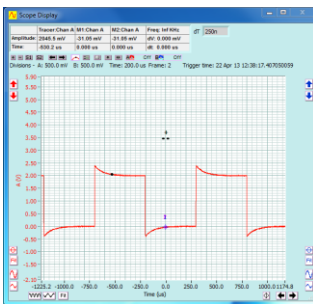

Overshoot or Slow Rise-time

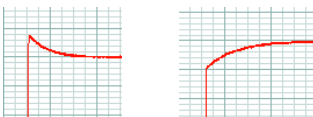

Note The graph may have either over-shoot or slow rise-time.

Both overshoot and slow rise-time require correction to compensate the probe capacitance and ensure a flat frequency response.

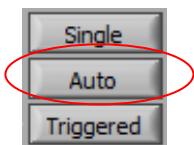

On the Control Panel click the **Auto** button.

Compensated

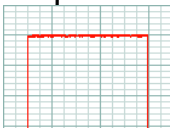

Adjust the small red screw in the body of the BNC connector end of the probe until the graph is flat. Repeat the process for all oscilloscope probes.

Note You may like to do this on B channel, to familiarize yourself with the B channel controls.

Reset Probe settings to x1 on Control Panel and probes

3.8 Changing the Trigger Edge

In the captures shown in the previous topics the Cleverscope has triggered on the falling edge. To change this to trigger on the rising edge go to the **TRIGGER** area on the Control Panel.

Trigger 1 Slope

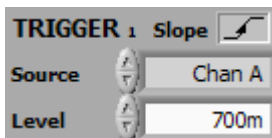

Click in the Source field or use the arrows to select the trigger source. In this instance it is to trigger from channel A (**Chan A**).

Click on the **Slope** symbol to toggle to a rising edge trigger.

3.9 Setting Trigger Level

Cleverscope Tools



On the Cleverscope Tools click on either the rising edge or falling edge trigger button.

In addition to setting the trigger to a rising or falling edge it should show a black line across the display at the voltage level at which the display will attempt to trigger.

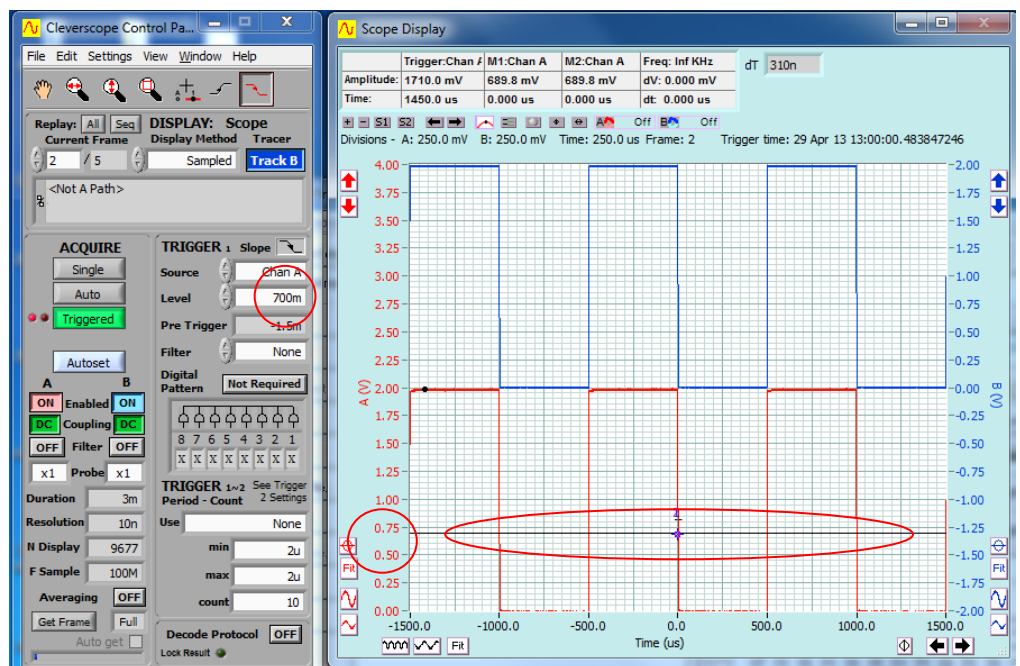

You should be able to see the display change to show a trigger on the selected edge.

You can toggle the trigger Edge button and watch the display in the Scope Display change each time.

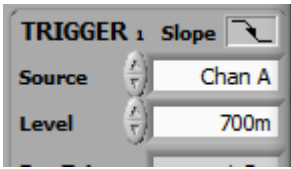

Adjust the trigger level by dragging the line to the required point. A small Rising or Falling edge symbol will appear on the graph. Click and drag the line to the required voltage level.

You can also type the trigger value directly into the Level window. Here we have entered 700 mV.

3.10 Adjusting the Scope Display

You can set up the acquisition manually to fine tune what **Autoset** has initially selected. Display controls are placed on the sides and bottom of the Scope display.

Vertical Axis Setting

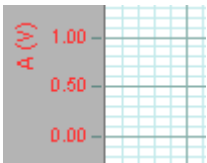

Use the up (↑) and down (↓) vertical display buttons and the vertical expand (⏏) and contract (⏏) buttons for channel A to size the displayed waveform the way you would like to see it.

As an example you could select 0.50 volts per major horizontal gridline as shown to the left.

You can also over-type the end values of the displayed axis to change the axis as you want. Value are in the current scale. If, for example, the left hand time axis displays -1500, and the display units are us, you can overtype -3000 to change the left hand end to -3000 us. Hit Enter to register the change.

Go to the Cleverscope Control Panel window.



In the **AQUIRE** area, click the Single button to acquire a single frame of signal data. The **Scope Display** will then display the acquired signal. In the example below, the the trigger is at 700 mV.

The auto-fit buttons (Fit A and Fit B) for channel A and B can be used to bring the signal traces into view. Cleverscope will apply the optimum vertical scaling and positioning for the signal data.

For the vertical scale, the positioning and scaling of the signal trace with respect to time can be altered using the horizontal display buttons

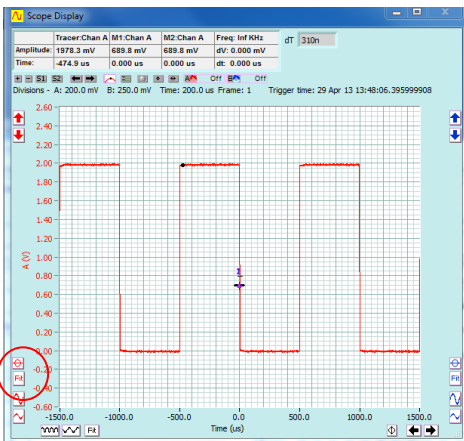

The screen at left shows the capture after the Channel A auto-fit button was clicked.

Time Axis

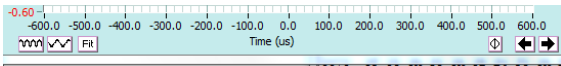

Contract Time

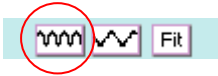

The screen at left shows the capture after the Channel A Contract Time button was clicked.

The display will adjust each time the button is clicked.

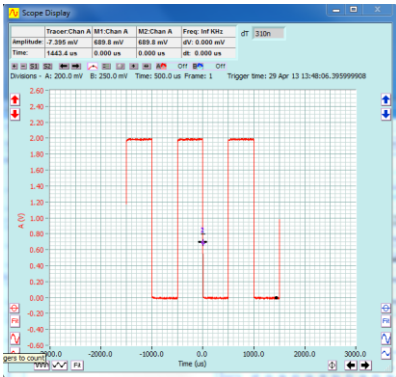

Note The trigger point is always positioned at time zero on the horizontal axis.



The screen at left shows the capture after the Channel A Expand Time button was clicked.

The display will adjust each time the button is clicked.

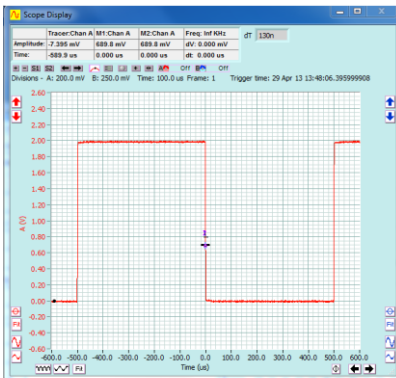

Channel B behaves the same as Channel A.

3.11 Signal Generators

If you ordered your Cleverscope to be supplied with the CS700A Signal Generator module fitted you can now use that to experiment further with capturing signals at different frequencies and wave shapes (sine, square and triangle).

Chapter 11, CS700A Signal Generator Module Controls describes the use of the Signal Generator module. (Note you can upgrade your Cleverscope to include the CS700A if it wasn't fitted ex-factory.)

You can also use the internal Signal Generator Simulator to experiment further with capturing signals at different frequencies and wave shapes.

Chapter 12, Internal Signal Generator Simulator describes the use of the internal software Signal Generator Simulator. Note the Simulator is software only and the connection to the Channel A & B inputs is done internally so no external connections are required. You cannot use the simulator for testing external units.

3.12 Keyboard Shortcuts – Quick Reference

Movement:

← and → move the cursor left and right

Shift + ← and → move the graph left and right

Ctrl + ← and → change the x-scale up or down, centred on the tracer

↑ and ↓ move the selected graph up and down

Shift + ↑ and ↓ move the selected graph up and down

Ctrl + ↑ and ↓ change the y-scale up and down, centred on the tracer

Markers:

1 and **2** set markers one and two

Spacebar sets the next marker

Graph Viewing:

Tab swaps channels

A autoscales the graphs

PageDown zooms in on the tracer

PageUp zooms out on the tracer

L locks the tracking display position on the current scope display tracer position

F10 automatically sets the graph scales and trigger settings

Control:

C or **Ctrl** + **C** copies the graph to the clipboard

X or **Ctrl** + **X** clears the graph

P or **Ctrl** + **P** prints the graph

F1 chooses the Pan/Tracer cursor

F2 chooses the Annotation cursor

F3 chooses the Rising Trigger cursor

F4 chooses the Falling Trigger cursor

Sampling:

F7 initiates a single acquisition

F8 initiates automatic acquisition

F9 initiates triggered acquisition

Mouse Wheel:

The mouse wheel acts as a virtual knob on whatever control was last selected. So if you select the Chan A Contract button, and then use the Mouse Wheel, the wheel acts as a virtual knob on the Channel A Volts/div.

Note You can copy the keyboard shortcut control list from the **About Cleverscope** window and paste wherever it is helpful for you.

4 Cleverscope Control Panel

The Cleverscope Application software provides a **Control Panel** to setup and control signal acquisition. A number of display windows show alternative but simultaneous views of signal and spectrum data. It also has additional windows that control the way the signal data is processed and displayed as well as controls for the optional CS700A Signal Generator.

The **Cleverscope Control Panel** contains all of the controls and menu items for capturing, and saving signal data.

Note You can individually size and position each window to optimize the ease of use and views of signal and spectrum data.

| | |
|-------------------------------|---|
| Control Panel | Normally displayed when the Cleverscope Application is started. |
| Minimise Control Panel | Click minimise icon. |
| Close Control Panel | Click the X button to Exit Cleverscope and close all windows. |
| TOOLS zone | Selects application wide tools. |
| DISPLAY zone | Settings for signal data storage and display. |
| ACQUIRE zone | Settings for signal acquisition. |
| TRIGGER 1 zone | Trigger settings for Trigger 1. |
| TRIGGER 1~2 zone | Trigger settings for Trigger 1 and 2. |
| Decode Protocol zone | Protocol decode settings. |

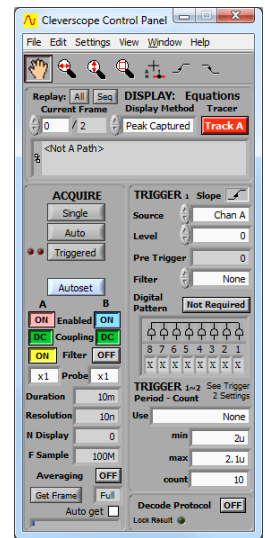

4.1 Cleverscope Tools Zone [Control Panel]

The Cleverscope Tools zone contains controls that apply to all Cleverscope displays. Buttons are used to activate the controls to pan a graph, zoom it, annotate it, adjust floating markers, or set the trigger level.



Cleverscope Tools Zone buttons

Hand Tool



The 'Hand Tool' ('grabbing tool') or Pan cursor tool is used to pan the graph by dragging anywhere inside the graph to move it into the desired position.

Click on the '**grabbing hand**' tool button. Move the mouse cursor on to the display. Hold down the left mouse button and drag the screen to move it.

Horizontal Expand



The **Horizontal Expand** cursor tool is used to horizontally expand the graph section in which it is used. Click on the '**Horizontal Expand**' tool button. Move the mouse cursor on to the display, at the point you want to expand.

Click and hold down the Left mouse button to drag the section line left or right to highlight the area to be zoomed. Release the left button, and the selection will expand to fit the screen. Use the Back History button  to undo the change.

Vertical Expand



The **Vertical Expand** cursor tool is used to vertically expand the graph section in which it is used. Click on the **Vertical Expand** tool button. Move the mouse cursor on to the display at the point you would like to expand.

Click and hold down the Left mouse button to drag the section line up or down to highlight the area to be zoomed. Release the left button, and the selection will expand to fit the screen. Use the Back History button  to undo the change.

Selected Area



The '**selected area**' zoom tool is used to zoom on a rectangular area on the display.

Click the Selected Area tool button. Move the cursor on to the display.

Position the mouse cursor on the top left corner of the area to zoom and then click and hold the left mouse button to drag a rectangle across the area of interest.

Release the left mouse button at the bottom right corner of the area you want to zoom into. The display will expand to fill the display with the contents of the selected area rectangle. Use the Back History button  to undo the change.

Annotation



The **Annotation** tool is used to add annotations to graphs.

Click on the tool button to activate, and move the mouse cursor onto the display.

Click the Left mouse button at a position in a graph to locate the text. Text is placed above, and centred on the insertion point.

Drag the little open circle to move the annotation.

The horizontal position of the text is locked to a position in time corresponding to where the annotation cursor was clicked.

The vertical position of the text is locked to a voltage level corresponding to the where the annotation cursor was clicked and for whichever channel (A or B) was selected at the time.

This tool is also used to move floating line marker cursors, see the section on **Cleverscope Displays** - Graph .

Trigger Cursor Tool Rising Edge



The Trigger Cursor tools place a black horizontal line on the display at the Trigger Level.

The Rising Edge (Slope) trigger will trigger capture on a rising edge.
The Falling Edge (Slope) trigger will trigger capture on a falling edge.

Trigger Cursor Tool Falling Edge



Trigger source channel and the axis to be used to set the trigger level are determined by whichever channel (A or B) is selected at the time the Trigger Cursor tool button is clicked.

The voltage at which trigger will occur can be set or adjusted by dragging the Trigger Cursor to a new position on the display.

Trigger level voltage can also be set by typing a value in the Trigger Level field or using the up and down arrows in the Trigger Level field in the Trigger 1 zone on the Cleverscope Control Panel.

Toggle Trigger Slope

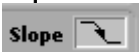

Also the Slope button in the Control Panel Trigger 1 zone can be used to toggle between rising and falling edge triggering.

Click Left mouse button to change the slope between Rising and Falling edge triggering.

Note: Dragging the Trigger Cursor to a new position will change the value of the Trigger 1 Level field.

4.2 ACQUIRE Zone [Control Panel]

Acquire zone buttons provide access to establish the capture options.

4.2.1 Acquire

Use one of the THREE **ACQUIRE** buttons to start and stop signal capture

Acquire Click on **Single**, to capture a single acquisition when the trigger condition is met.

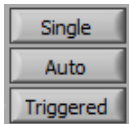

Click on **Auto** to capture continuing acquisitions. If the trigger condition is met, acquisitions are triggered. If the trigger condition is not met, acquisitions automatically continue at the **Update Rate** (see **5.3.6 Acquisition settings** dialog).

Click on **Triggered** to capture continuing acquisitions, but wait for the trigger condition to be met before capture. Uses the **Update Rate** to set the maximum update rate.

4.2.2 Autoset

Autoset Click button to automatically set the graph scales and trigger settings.

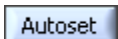

Autoset places Channel A in the bottom half and Channel B in the top half of the graph and shows 3 cycles of the signal in the **Scope Display** and 2 cycles in the **Tracking Display**. A quick way to view a new set of signals.

4.2.3 Charting

Note: Charting is only available in Application version **4.7xx** and above.

Chart

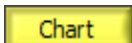

Click button to start a charting session.

To setup a charting session, on the **File** menu click **File Options**.

For more information see the section **5.1.1 Format** of the Binary file

The binary file is organized as follows:

Binary file Structure

The binary file has a 64 byte header followed by an array of samples. The 64 byte header is organized as 8 x IEEE 64 bit double precision real numbers, stored big endian, with the following format:

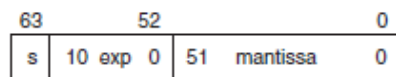

The header words are:

- Version 1.3
- n number of samples in one frame
- Frame The current frame number
- dt or df sample interval, in seconds, or df, freq interval
- T0 or F0 Time at which sampling started, relative to the trigger.
- Ttrigger Local time at which trigger occurred, in seconds, 1us res. Time 0 is 00:00, midnight, starting 1 January 1904 UTC
- Fn Number of frames saved
- Flags Bit 0: 0=file contains time base data (T0 and dt)
1=file contains spectrum data (F0 and dF)

Each sample is in an IEEE 32 bit single precision format real number:

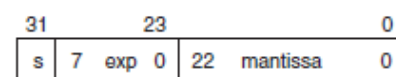

Options

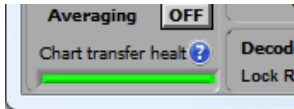

During charting, the bottom left corner of the **Control Panel** changes to show **Chart transfer health**.

Click the help icon () for more information.

Toggle Automatic Scrolling Click **Chart** () to toggle automatic scrolling of the on the **Scope Display** graph.

4.2.4 Enabled

Chart



Click ON button to toggle channels ON or OFF to determine whether signals are displayed or not. Un-displayed signals are still acquired, and can be displayed by turning the channel ON.

Controls are independent of each other.

4.2.5 Coupling

Coupling



Click button to toggle channels to DC Coupled or AC Coupled.

Controls are independent of each other.

4.2.6 Filter

Filter



Click button to toggle channels to use a 20 MHz pre-filter and/or a moving average filter (with time constants from 40ns to 1.28us) in the incoming signal stream.

Filter Setup

To setup which filter is used see the section **5.3.6 Acquisition settings**.

20Mhz Pre Filter

The 20 MHz pre-filter employs a 5th order low pass anti-aliasing filters on each channel to prevent high frequency out-of-band signals from aliasing back into the displayed signal graph.

The unit always samples simultaneously for both channels at 100 M samples/s.

Corner Frequency

Corner frequency of the anti-aliasing filters is 20 MHz.

Decimation

If the effective sample rate (e.g. 1MSPS when sampling 2 seconds with 2 frames on a 4M Cleverscope) is lower than the actual sample rate (100 MSPS), then decimation is used to achieve the effective sample rate. If the **Filter** button is on, then equally spaced sample decimation is used, and intervening samples are lost (though they may have been filtered).

If the **Filter** button is off then peak-captured decimation is used, where both the highest and lowest values of the intervening sample set are captured. This ensures that short duration signals are visible. The sample set is itself decimated according to the **Display Method**.

4.2.7 Probe

Probe



Click in the field to select from a dropdown list to set **Probe** attenuation for each channel to match the attenuation switch settings of the connected probe.

Options are **x1**, **x10**, **x100**, **x1k**, **x20**, **x50** or **x200**.

4.2.8 Duration, Resolution, N Display and F Sample

Duration

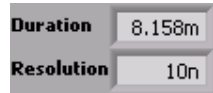

The sampling **Duration** is the length of time for which a continuous sequence of samples is available for display. The time **Resolution** is the minimum time between samples available for display.

Resolution

Duration and the **Resolution** are updated after an acquisition has been completed using the **Single**, **Auto** or **Triggered** buttons. The **Duration** is at least equal to the time width of the **Scope Display**, but may be longer to make best use of the sample buffer.

Resolution is set by the number of samples available in each frame. A total of 4 or 8 million samples divided by the number of sample frames are available. Reducing the number of sample frames increases the number of samples available, and so will increase the time resolution. Here the sampling duration is 8.158 ms, with a time resolution of 10ns per sample.

N Display



N Display shows the number of samples on the display and the number of samples that would be saved if you selected **Save As** from the **File** menu. Generally this is equal to the value **Display Samples** in **5.3.6 Acquisition settings**.

F Sample

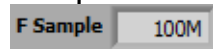

F Sample shows the sample capture frequency in Hertz. The example shows 100MHz. If you use an external sample clock this will be different.

4.2.9 Averaging

Averaging



Clicking the button toggles **Averaging** ON and OFF to arithmetically average a number of signal frames together in the PC to reduce the effect of noise, or to see the long-term value of a varying signal.

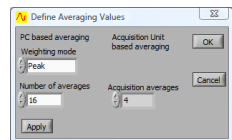

On the **Settings** menu, clicking **Averaging** allows control of both PC based averaging with **Weighting mode** and **Number of averages**, and Cleverscope Acquisition Unit (CAU) based averaging with **Acquisition averages**.

Refer to **Methods for Displaying Signals** section below for acquisition averaging using the **Waveform avg** display method.

Weighting mode

Weighting mode allows you to select one of three types of averaging: **Linear**, **Exponential** and **Peak**. This is used in conjunction with **Number of averages** as explained below.

Linear

Linear averaging applies equal weighting over a number of signal frames, processing the number of frames chosen in **Number of averages** before presenting the result.

Exponential

Exponential averaging provides a moving average where a greater weighting is applied to more recently acquired frames than older frames. The averaged frame is displayed after every acquisition. Each new frame is scaled prior to being added to the aggregated past signal.

The scaling is determined by the **Number of averages**. A large number results in a small proportion of the new signal contributing to the average.

Peak

Peak averaging is used to accumulate maximum frequency points from the spectra of a number of frames and is therefore only applied to data displayed in the spectrum display. It may be used to generate a frequency response display (Gain/Phase plot).

Because noise is random, and has an average value of 0, averaging will reduce the effective amplitude of the noise in each time sample. The amount of reduction is dependent on **Number of averages** – making this number larger, will reduce the noise more, but it will take longer to settle the signal being measured.

Reset Average On the **Settings** menu, click **Reset Average** (or Ctrl + R) to reset the average to 0.

4.2.10 Get Frame

Get Frame

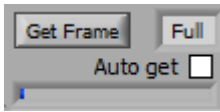

Click **Get Frame** button to get the Frame Buffer or last sequence into PC memory. The Cleverscope application usually moves only the sample set required for display from the Cleverscope Acquisition Unit (CAU) into PC memory. If you perform a zoom or pan this is done by moving samples from the CAU into the PC. If you Get Frame, the entire sample set is moved to the PC, and later zoom and pan uses the PC sample set, rather than the CAU sample set. **Save As..** saves the available sample set to disk. **N Display** will be updated to the samples in PC memory. The maximum size of a Frame is determined by dividing the total number of samples in the CAU (4M or 8M) by the number of frames (usually 2). Use **5.3.6 Acquisition settings** to set the **Number of Frames**.

Full Click **Full** field to select the size of the frame buffer transferred from a dropdown list. Options are: *Full, 50%, 10%, 5%, 2% or Seq.*

This is useful to limit the File Size after a **Save As..** with a full frame in PC memory.

Auto Get Click in the checkbox to automatically get a full frame after each acquisition.

4.3 DISPLAY Zone [Control Panel]

The Display zone provides controls related to signal data storage and display are located in the **DISPLAY** area. Note: The Cleverscope acquisition unit is able to hold a number of sequential frames so that a history of older frames can be recalled.

Display Zone

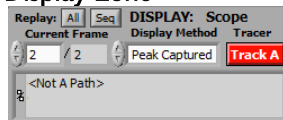

Current Frame

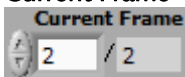

Click on the arrows or type a number directly in the field to display an earlier frame.

Note: Following an acquisition the **Current Frame** number represents the latest frame acquired. The number of frames available in the store is displayed to the right of the **Current Frame**.

The graphs will update to display the signal in the frame selected. **Current Frame '1'** is always the oldest frame, the higher the number, the more recent the frame.

The maximum is set on the **Settings** menu, clicking **Acquisition settings** and setting the **Number of Frames**. The 4 Million samples available in the Cleverscope acquisition unit are divided between the **Number of Frames** allocated.

Replay

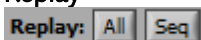

Click the **All** button to replay all frames in memory.

Click **Seq** button to replay all the frames in the last captured sequence. Use in conjunction with **Get Frame**.

Tracer

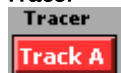

Click the Tracer button (Track A) to select which channel the tracer will apply to.

The tracer is a small black circle that can be moved along the A or B channel signal trace by selecting a display (Scope, Spectrum, Tracking, etc.) and simply moving the mouse left or right.

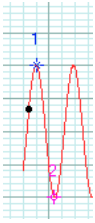

Note: As the tracer is moved along a signal (or spectrum) its position in both amplitude and time (or frequency) is displayed in the **Information** area at the top of the display graph. The tracer assists the accurate positioning of markers which enable points of interest to be tagged and calculations on selected segments of signal data to be undertaken.

See also the section on **Scope Display** for a description on the use of the tracer and markers.

File Path Display

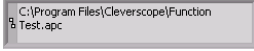

Cleverscope lets you save signal data as either a Cleverscope, text or binary file. On the **File** menu, click either **Save As**, **Save as Text**, **Save as Binary** or **Save** to do this. The file path for the last stored file is displayed in the path display box.

Display Method

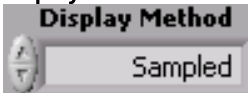

Display Method selects the method of displaying signal data.

Click the arrows or inside the field to select a **Display Method** from the dropdown list

Note: Samples are taken at regular intervals from the sample frame. None of the intermediate samples are displayed, which means that some signal information, such as high frequency signals, or pulses will not be seen. The sampling interval depends on the maximum frequency or time resolution required to be displayed and is automatically selected by Cleverscope depending on display settings.

Peak Captured



All samples are processed, with both the minimum and maximum value of the signal being displayed at every pixel point on the screen. Hidden pulses will become visible, and high frequency content will be seen as a solid bar on the screen.

Filtered

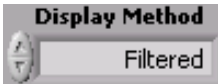

A 1st order low pass filter with a corner frequency of 1 MHz is applied to the recorded samples. Filtering may be useful when viewing low frequency (<500 kHz) signals at low levels, as sample noise is significantly reduced.

Repetitive



The acquired signals are repetitively sampled over many points to build up a picture of one cycle of the signal. This results in high frequency repetitive waveforms being displayed with greater time resolution. Note: This method only works with repeating signals of greater than 1 MHz frequency.

Waveform avg



Waveform averaging is performed in the Cleverscope Acquisition Unit (CAU). The CAU captures multiple frames in quick succession, averages these frames, and transfers the result to the PC. This is much faster than averaging in the PC. See the **Averaging** section below for PC based averaging.

Define Averaging Values

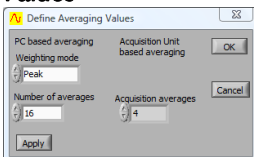

On the **Settings** menu, clicking **Averaging** allows you to select the **Acquisition averages** that are used when **Waveform avg** is selected. The choices are **4**, **16**, **64**, or **128**. A higher number increases the averaging.

Waveform averaging requires a stable trigger and is only active when **Triggered** acquisition is used. Waveform averaging automatically increases the number of frames being recorded to one more than the waveform averages selected. Once you complete using waveform averaging you may wish to set the number of frames to a lower number to increase time resolution.

4.4 TRIGGER 1 Zone [Control Panel]

Trigger 1 is the main trigger and is setup in the **TRIGGER** area on the **Cleverscope Control Panel**.

Note: m=milliseconds, u=microseconds, n= nanoseconds

Trigger Zone

All the triggering controls are grouped in the **TRIGGER** zone apart from the trigger cursors which are with the other tools at the top of the Cleverscope **Control Panel**.

Slope



Click on the **Slope** symbol to toggle whether the voltage level will be increasing or decreasing through the trigger point when triggering occurs.

The triggering slope is initially determined by the choice of an upward or downward trigger cursor but it can be changed at any time using the slope button without changing the level of the trigger point.

Source



Click on the arrows or in the field to select the source of triggering.

Options are Channel A, Channel B, External trigger, Digital inputs, or the Link input which is available on the Mini-Din connector at the back of the capture unit.

Level



Click on the arrows or type a value in the field to set the triggering Level

This is normally set using the trigger cursors in conjunction with the Scope Display. A separate level is remembered for each source channel.

Hysteresis

Note: Hysteresis is used to reduce false triggering due to noise. The normal hysteresis is 2.5% of the amplitude range. Signals must fully transition through the hysteresis band to cause a trigger.

Pre Trigger



The Pre Trigger time displayed is the time between the first sample in a frame and the trigger point.

The trigger point is always set at time zero in the Scope Display.

The amount of pre-trigger time is determined by how much pre-trigger time you are requesting to view in the Scope Display.

Scope Display left and right horizontal controls (← and →) set the pre-trigger time. If the number is negative you are capturing signal before the trigger occurs. If the number is positive you are waiting the given time following a trigger before capturing the signal.

Filter



Click on the arrows or in the field to select a filter from the dropdown list.

Low Pass



Low Pass filtering is used to capture a low frequency signal in the presence of high frequency noise.

Hi Pass



Hi Pass filtering is used to capture high frequency signals (such as edges) in the presence of a low frequency signal; for example triggering on a pulse on a mains frequency waveform.

Noise



Noise filtering is used to achieve a more reliable trigger in the presence of large amounts of noise. This is done by increasing the hysteresis band about the trigger point to 7.5% of the amplitude range. A wider hysteresis band means that the signal amplitude must be wider than the hysteresis band to ensure reliable triggering. Signals must fully transition through the hysteresis band to cause a trigger.

4.5 Trigger 2 Settings (Ctrl+T) [Control Panel]

Note: Trigger 2 settings are in a pop-up window accessed via the **View** menu
 Click on the **View** menu at the top of the Cleverscope Control Panel and select Trigger 2 Settings (or Ctrl + T).

Help

Click on the button to display the following **Help** screen

Use

Duration Triggers

- Trig 1~2 < min: Trigger if the duration Trig 1~2 is less than min
- min <=T1~2 <= max: Trigger if the duration Trig 1~2 is between min and max
- Trig 1~2 > max: Trigger if the duration Trig 1~2 is greater than max

Count Triggers

- Count Trig 1: Trigger if Trigger 1 occurs Count times
- Count Trig 2: Trigger if Trigger 1 occurs, followed by Trigger 2 occurring Count times.

Duration - Count Triggers

- T1~2<min:count T2: Trigger if duration Trig 1~2 < min, and then Count T2's occur
- in T1~2 : count T2: Trigger if duration Trig 1~2 in range, and then Count T2's occur
- T1~2>max:count T2: Trigger if duration Trig 1~2 > max, and Count T2's occur

OR Trigger Trigger if either Trig 1 OR Trig 2 occur

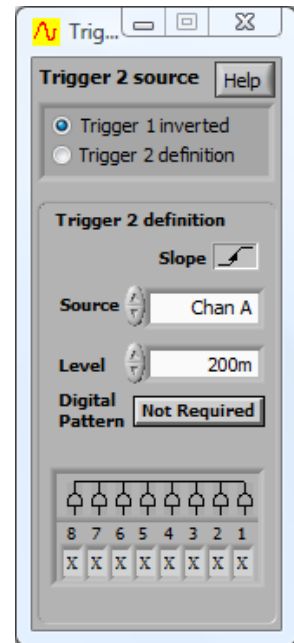

- Trigger 1 Inverted** Trigger 1 inverted sets Trigger 2 to trigger on the inverted value of Trigger 1.
- Trigger 2 Definition** Defines Trigger 2 as per the completely separate Trigger 2 definition area below.
- Slope** Click on the Slope symbol to toggle whether the voltage level will be increasing or decreasing through the trigger point when triggering occurs. The triggering slope is initially determined by the choice of an upward or downward trigger cursor but it can be changed at any time using the slope button without changing the level of the trigger point. These controls operate the same as the equivalent controls for Trigger 1.
- Source** Click on the arrows or in the field to select the source of triggering from the dropdown list. Options are Channel A, Channel B, External trigger, Digital inputs, or the Link input which is available on the Mini-Din connector at the back of the capture unit.
- Level** Click on the up or down arrow or type a value in the field to set the triggering Level. Hysteresis is used to reduce false triggering due to noise. The normal hysteresis is 2.5% of the amplitude range. Signals must fully transition through the hysteresis band to cause a trigger. Trigger 2 does not have a filter option.

4.6 Trigger 1~2 Zone [Control Panel]

Period – Count Trigger provides additional trigger control on the duration between Trigger 1 and Trigger 2 or counting of triggers or a combination of duration and counting

Note: m=milliseconds, u=microseconds, n= nanoseconds

| | |
|-----------------------------|--|
| Use | Selects an option from the Use menu |
| Trig 1~2 < Min | Triggers if the duration between Trigger 1 and Trigger 2 is less than min time. |
| min<T1~2 < max | Triggers if the duration between Trigger 1 and Trigger 2 is between min time and max time. |
| Trig 1~2 > max | Triggers if the duration between Trigger 1 and Trigger 2 is greater than max time. |
| Count Trig 1 | Triggers when Trigger 1 has occurred count times. |
| Count Trig 2 | Triggers when Trigger 1 occurs followed by Trigger 2 occurring count times. |
| T1~2<Min:count T2 | Triggers if the duration between Trigger 1 and Trigger 2 is less than min time and then counts Trigger 2 occurring count times. |
| in T1~2 : count T2 | Triggers if the duration between Trigger 1 and Trigger 2 is between min time and max time and then counts Trigger 2 occurring count times. |
| T1~2>max:count T2 | Triggers if the duration between Trigger 1 and Trigger 2 is greater than max time and then counts Trigger 2 occurring count times. |
| T1 OR T2 | Triggers on either Trigger 1 or Trigger 2 . |
| min | Sets the minimum period for which the trigger can be active Note: you can use m=milliseconds, u=microseconds, n= nanoseconds |
| max | Sets the maximum period for which the trigger can be active Note: you can use m=milliseconds, u=microseconds, n= nanoseconds |
| count | Sets the number of triggers to count |

4.7 Digital Pattern Triggering Zone [Control Panel]

The **Digital Pattern** is an optional qualifier to the analog trigger, or is used to define the digital trigger (**Trigger Source = Dig Trig**). When used as a qualifier do NOT use digital edges, as it is extremely unlikely they will occur at the same time as the analog edge.

Digital Pattern Not Required

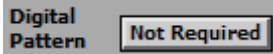

Click the button to toggle digital pattern triggering.

When **Not Required** is selected, analog triggering proceeds as explained above. If the **Trigger Source** is Dig Trig, the button is ignored.

Digital Pattern Required

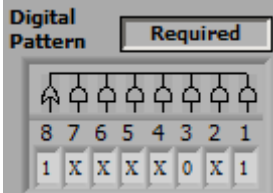

When **Required** is selected, the analog trigger cannot take place until the digital inputs match the digital pattern chosen.

Example: If the **Digital Pattern** is set as per screen shot an analog trigger will not be recognized until **Digital Inputs 1 and 3** match **1 and 0** respectively, OR **Digital Input 8** is 1. Inputs labelled **X** are 'don't care'.



OR inputs

If the **Trigger Source** is **Dig Trig**, digital transitions are included to define the trigger.



Click on the **OR** symbol above the digital input to set the OR option.



AND inputs



Click on the **AND** symbol above the digital input to set the AND option.

OR Triggering

Triggers when any one of the **OR** conditions are met.

AND Triggering

Triggers when all of the **AND** conditions must be met.

Triggering Conditions



0 – the digital input must be below the digital threshold

1 – the digital input must be above the digital threshold

X – the digital input is ignored

↑ - the digital input transitions from 0 → 1

↓ - the digital input transitions from 1 → 0

Note: When Digital Triggering is selected as the triggering Source then Cleverscope will trigger when the digital inputs match the pattern set by the digital input selection box.

Example: The pattern shown in the screen shot will cause a trigger if input 1 = 0, input 2 = 1, and either input 7 falls or input 8 rises.

4.8 Decode Protocol zone [Control Panel]

The protocol decoder is capable of decoding SPI, I²C, and RS232/422/485 serial data (UART).

Note: Decode Protocol is set up via the **View** menu **Protocol Setup**

Decode Protocol

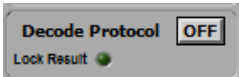

Click button to toggle Off ON

Click button to toggle **Lock Result** ON or OFF.

Lock Result

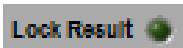

With **Lock Result** set ON there will be no updates from the sampler.

Useful when using Maths to zoom in on the result on the **Tracking Display** without the Maths being re-applied.

5 Control Panel - Menus

Only the Cleverscope Control Panel has the pull down menus shown below:

File Menu

open and save signal data, printing

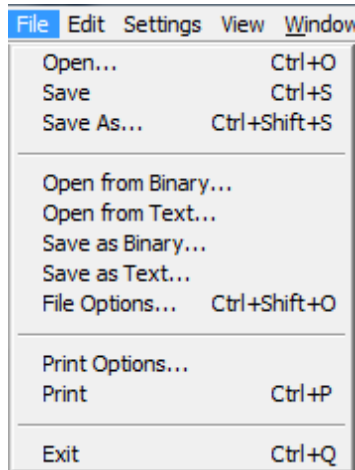

Settings Menu

set-up and options

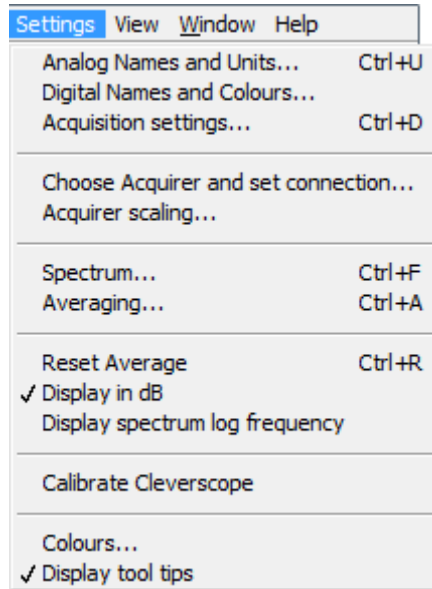

View Menu

selects which windows are displayed

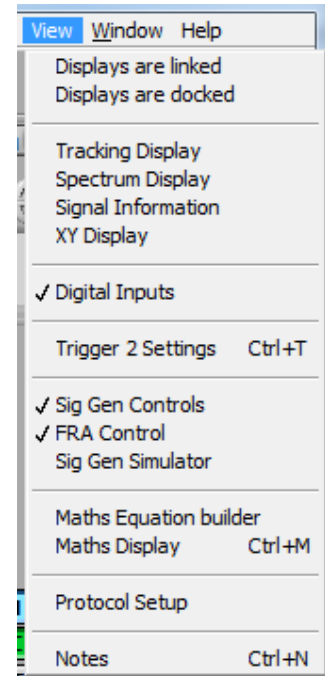

Edit Menu

copying and clearing graphs

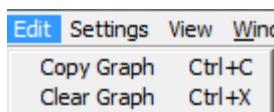

Window Menu

for selecting the active window

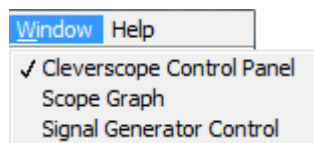

Help Menu

keyboard shortcuts, license and version info

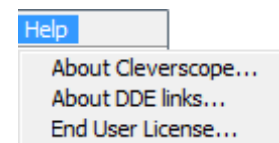

5.1 File Menu [Control Panel]

The File menu lets you save signal and graph data, open saved data for display and analysis, print displays and exit the application.

File Menu

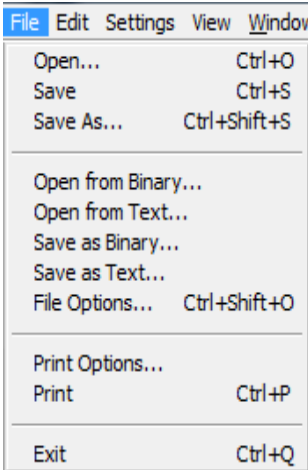

- Open** Click to open previously saved Cleverscope signal data .apc files.
- Save** Click to save a file containing Cleverscope data (.apc).
- Save As** Click to save a (copy of a) file containing Cleverscope data (.apc).
- Open from Binary** Click to open previously saved binary data files.
- Open from text** Click to open previously saved text files.
- Save as Binary** Click to save a file as binary data.
- File Options** See below.
- Print Options** See below.
- Print** Opens the windows print dialog box.
- Exit** Close the Cleverscope application.

5.1.1 Format of the Binary file

The binary file is organized as follows:

Binary file Structure

The binary file has a 64 byte header followed by an array of samples. The 64 byte header is organized as 8 x IEEE 64 bit double precision real numbers, stored big endian, with the following format:

| | | | | | | | |
|----|----------|----|----------|--|--|---|--|
| | | | | | | | |
| 63 | 52 | | | | | 0 | |
| s | 10 exp 0 | 51 | mantissa | | | 0 | |

The header words are:

- Version 1.3
- n number of samples in one frame
- Frame The current frame number
- dt or df sample interval, in seconds, or df, freq interval
- T0 or F0 Time at which sampling started, relative to the trigger.
- Ttrigger Local time at which trigger occurred, in seconds, 1us res. Time 0 is 00:00, midnight, starting 1 January 1904 UTC
- Fn Number of frames saved
- Flags Bit 0: 0=file contains time base data (T0 and dt)
1=file contains spectrum data (F0 and dF)

Each sample is in an IEEE 32 bit single precision format real number:

| | | | | | | | |
|----|---------|----|----------|--|--|---|--|
| | | | | | | | |
| 31 | 23 | | | | | 0 | |
| s | 7 exp 0 | 22 | mantissa | | | 0 | |

5.1.2 Options (Ctrl+Shift+O) [File Menu]

File Options is used to control the way files are opened and saved.

Open Options allow the automatic opening of saved files. This can be used in conjunction with **Save Options** to automatically process files.

File Options Dialog

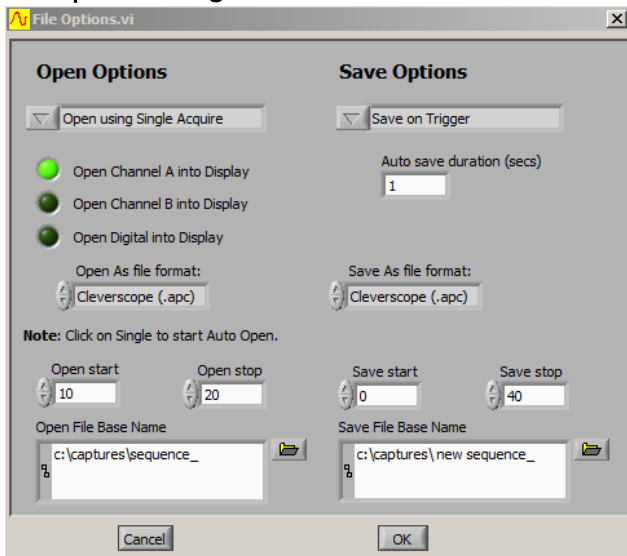

The File Options dialog (explained below) is used to set automated open and save options. This example shows Cleverscope .apc files being automatically opened into just Channel A, every time the Single Acquire button is clicked. Files named *sequence_10* through to *sequence_20* will be opened. Channel B and the Digital signals will be left as they are. This could have been used to compare 11 recent captures with a reference captured to Channel B earlier.

This example also shows a file being automatically saved every time there is a trigger. Files are being saved as *new sequence_0* through to *new sequence_40*. Files are being saved in Cleverscope (.apc) format.

5.1.3 Open Options [File Menu]

File Open Options

Click on the up or down arrow or in the field to select from the dropdown menu.

Options are: Open Manually, Open using Single Acquire, Open Automatically, Open Automatically, Data Only, Open Manually, Data Only

Open Manually

Click on this option to select that a file can only be opened from the **File** menu.

Open using Single Acquire

Open enabled Open Disabled



The  button is shown to the left of the **Single** button.

X indicates Single is disabled

Toggling this disables and enables the automatic open.

Open Automatically

Click on the **Single** button to start the auto open and the file is opened automatically.

The  button is shown to the left of the **Single** button.

Toggling this disables and enables the automatic open.

Open Automatically, Data Only

Click on the **Single** button to start the auto open and the file is opened automatically but only the data is extracted from the file. None of the Cleverscope settings will be loaded..

The  button is shown to the left of the **Single** button.

Toggling this disables and enables the automatic open.

Open Channel A into Display

Click on button to activate. If not activated, Channel A is left as it is. This is useful for comparison purposes.

- Open Channel B into Display** Click on button to activate. If not activated, Channel B is left as it is. This is useful for comparison purposes.
- Open Digital into Display** Click on button to activate. If not activated, Digital values are left as they are. This is useful for comparison purposes.
- Auto save duration (secs)** Click in the field to type in the duration between Auto saves. Graphs are saved automatically after the duration has elapsed, and a trigger has occurred.
- Open As file format** Click on the up or down arrow or in the field to select from the dropdown list.
Options are: Cleverscope (.apc), Text (.txt), Binary (.bin)

Note: For all automatic opens a base file name must be specified in **Open File Base Name** and the file increment is controlled with **Open start** and **Open stop**. Open start is automatically incremented with each open.
- Open Start** Click on the up or down arrow or in the field to set the File Increment Start value.
- Open Stop** Click on the up or down arrow or in the field to set the File Stop value.
- Open Base File Name** Click on the up or down arrow or in the field to select the file Base Name.

5.1.4 Save Options [File Menu]

Save Options allow automatic logging of the signal data.

File Options Window

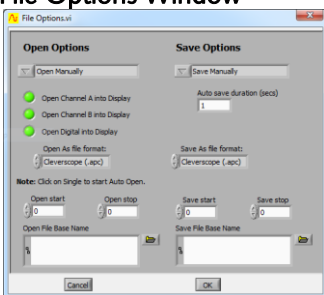

- Save Options** Click on the up or down arrow or in the field to select from the dropdown list. Options are: Save Manually, Save using Fast Save button, Save on Trigger Save on duration elapsed, Save following Open.
- Save Manually** Click on this option to select that files can only be saved from the File menu.
- Save Using fast Save button** Click this option to save the graph to an incrementing file name.
When Save using Fast Save button is selected, the Fast Save button  is shown in the tool bar. Clicking this button
- Save on Trigger** Click on this option to save a file is automatically on every trigger (this includes an Auto trigger).

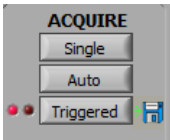

Save on Duration elapsed

The  button is shown on the right of the Trigger button. Toggling this disables and enables the automatic save.

Click on this option to save a file every Auto save duration (seconds) following a trigger.

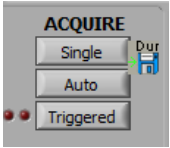

Save following Open

The  button is shown on the right of the Single button. Toggling this disables and enables the automatic save.

Click on this option to save automatically after any file is opened and after any processing, including maths.

Note: This is particularly useful for post-processing logged files.

Save As file format

Click on the up or down arrow or in the field to select from the dropdown list. Options are : Cleverscope (.apc), Text (.txt), Binary (.bin),

Save File Base Name

Click on the up or down arrow or in the field to select the file

Note: For all automatic saves a base file name must be specified in **Save File Base Name** and the file increment is controlled with **Save start** and **Save stop**. **Save start** is automatically incremented with each save

Save start and Save stop

Click on the up or down arrow or in the field to define the file increments

5.1.5 Print Options [File Menu]

Print Options Window

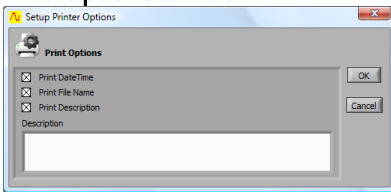

- Print Date Time** Print Options is used to choose what other information is printed with the graph. You can choose the date, time and a text description to be printed above a graph printout. Print is used to print the currently selected display or signal information window. .
- Print File Name** Click on the check box to toggle the option to print the file name.
- Print Description** Click on the check box to toggle the option to print the description entered into the description text box (below).
- Description** Click in the text box Type your description.

5.1.6 Export Chart [File Menu]

Note This feature is only available in version 4.7 and above.

Export Chart is used to export charting data in different formats. Clicking Help (?) expands the window to show help for each item.

Export Chart Window (4.7+)

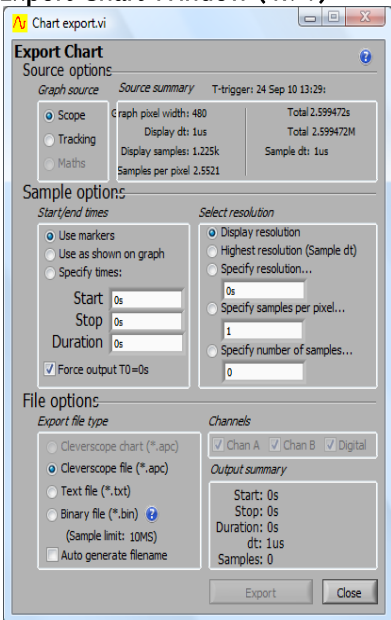

- Source options** Sets up the chart source
- Graph source** Select either *Scope* or *Tracking*.
- Source Summary** Summarises source data
- Sample Options** Sets up the sample to be exported. Under **Sample options**, select the **Start/end times** and **resolution**
- Start/end times** There are various means of selecting the start/stop times of the charting data that is to be exported..
- Select Resolution** There are various means of selecting the resolution of the charting data that is to be exported..
- Note** Use the tool tips (hover the cursor over an item) to see the range of possible values for **Start/end times** and **resolution**.
- File options** There are 3 file formats that can be written. **Export file type** and any **Channels** as needed.
- Export** Click **Export** button to save the exported data as selected.
- Close** Click **Close** when finished

5.2 Edit Menu [Control Panel]

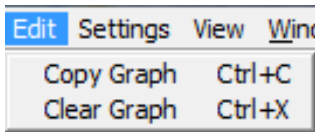

Copy Graph (Ctrl+C)

Click menu item to copy an image of the last selected graph or information window to the clip board. You can then paste the copied item into a document or similar in another application.

Clear Graph

Click **Clear Graph** menu item to clear signal data from the last selected graph.

5.3 Settings Menu [Control Panel]

The Settings menu contains all the options, preferences, and settings related to the acquiring and analysis of signal data, including calibration. In addition, you can choose different names, colours, and units for displaying graphs.

Settings Menu

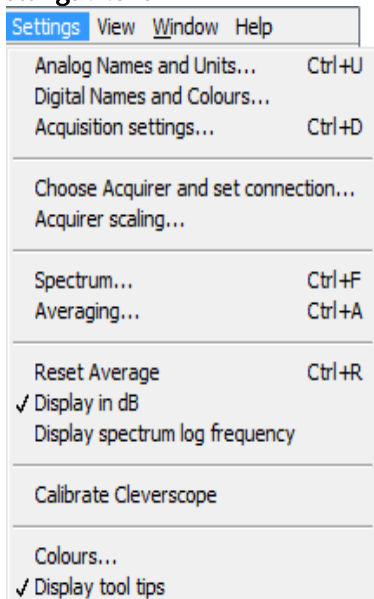

Analog Names and Units

Click to open Analog Names and Units window to assign names and units to display window axis.

Digital Names and Colours

Click to open Digital Names and Colours window to assign names and colours to digital inputs.

Acquisitions Settings

Click to open Acquisitions Settings window to set threshold voltages, Frame Store, ADC resolution, enable link output, filtering, sampling clock source and Update Rate.

Choose Acquirer and set connection

Click to open Choose Acquirer and set connection window to set type of acquirer and interface source.

Acquirer scaling

Click to open Acquirer scaling window to set Acquirer values to Volts.

Spectrum

Click to open Define Spectrum Parameters window to set transform type and FFT window, convert to degrees and unwrap phase.

Averaging

Click to open Define Averaging Values window to set weighting mode, number of averages and Acquisition average values.

Reset Average

Click to reset average.

Display in dB

Click to change axis to dB.

Display spectrum log frequency

Click to change Spectrum display frequency axis to logarithmic.

Calibrate Cleverscope

Click to open the calibration tools.

Colours

Click to open the Setup Colours window.

Display tool tips

Click to toggle

5.3.1 Analog Names and Units (Ctrl+U) [Settings Menu]

Analog Units allows you use units other than volts or dB's when displaying signal data.

Analog Names allow you to label the graph axis to represent the measurement of interest instead of the defaults

Analog Names and Units Panel

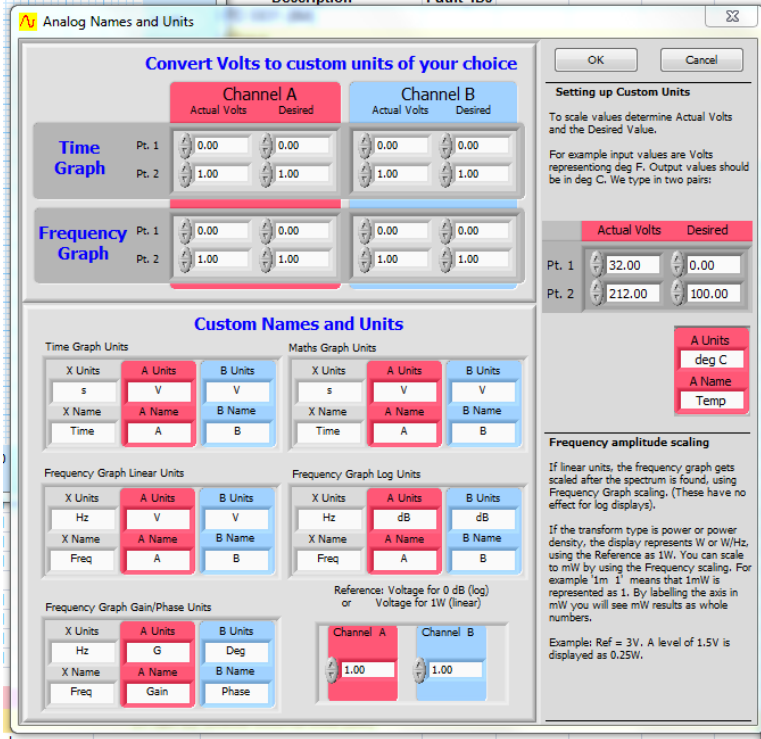

Setup units

To set up custom units you need to define the relationship between the internal units in volts and the units to be used for displaying signal data.

Straight Line Plot

A plot showing the relationship between internal units in Volts and your custom units must be a straight line. Points 1 and 2 (**Pt. 1**, **Pt. 2**) fix this straight line, and therefore define the scaling between internal units and your custom units.

5.3.2 Convert Volts to Custom Units Zone [Settings Menu]

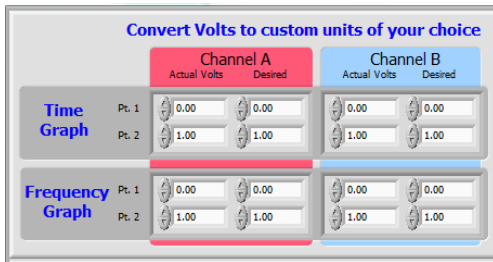

Pt 1, Pt. 2



Pt 1 - Point 1 on the graph – the first of the two points necessary to define the scaling between the signal data and the units to be used for display

Pt – 2 - Point 2 on the graph – the second of the two points necessary to define the scaling between the signal data and the units to be used for display

5.3.3 Example Setting up Custom Units [Settings Menu]

Description

A light energy generating system is connected to Channel A and has a terminal voltage of 0.28 volts for a total energy output of 3.4 joules, and a terminal voltage of 12.6 volts for a total energy output of 76 joules.

How would the Cleverscope be customised?

Actual Volts

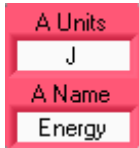

To customize the units for this system

Enter 0.28 for **Pt. 1** under **Volts** and 3.4 for **Pt. 1** under **Custom** for Channel A.

Also enter 12.6 for **Pt. 2** under **Volts** and 76 for **Pt. 2** under **Custom** for Channel A.

Then type *J* into Time Graph Units **A Units** and *Energy* into Time Graph Units **A Name**.

Desired

Note: Channel B can be similarly customized for the **Time Graph**, as can both channel A and B for the Linear, Logarithmic and Gain/Phase Frequency Graphs (spectrum display).

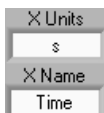

Both **Units** and **Name** labelling for the horizontal **X** axis can also be customized whether it be for time, or frequency (for linear, logarithmic or gain/phase graphs).

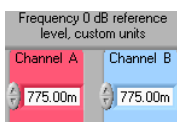

The zero dB reference point for the logarithmic Frequency (spectrum) graph can also be customized. The default 775 mV corresponds to 0dBm into a 600 ohm load. To display dBV change this value to 1.

5.3.4 Add Custom Names and Units Panel [Settings Menu]



5.3.5 Digital Names and Colours [Settings Menu]

Digital Names and Colours controls what digital inputs are displayed, what colour they are, their name, and how big the digital display area is.

Digital Input Definition Zone

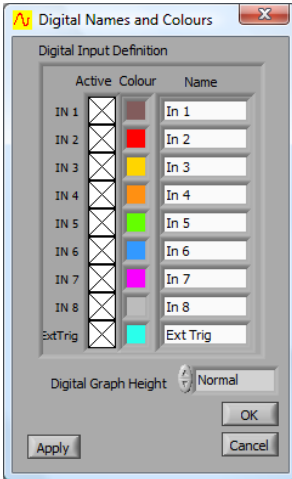

Active

Click in the **Active** check box to select which digital signals are displayed. Digital inputs can also be activated directly on the Scope display when Digital Inputs are displayed

Colour

Click in the Colour box and select a colour from the colour picker dialog if you want to change the colour of the input

Name

Click in the Name field and type in a new name to change the name of an input

Digital Graph Height

Click on the up or down arrow or in the field select either *Normal* or *Large* to change the height of the **Digital Inputs**, display. *Large* is twice the size of *Normal*.

5.3.6 Acquisition settings [Settings Menu]

Acquisition settings adjusts your Cleverscope Acquisition Unit for external trigger and digital input threshold voltages, the number of frames stored, sampler resolution, link output, update rate, and external clock source.

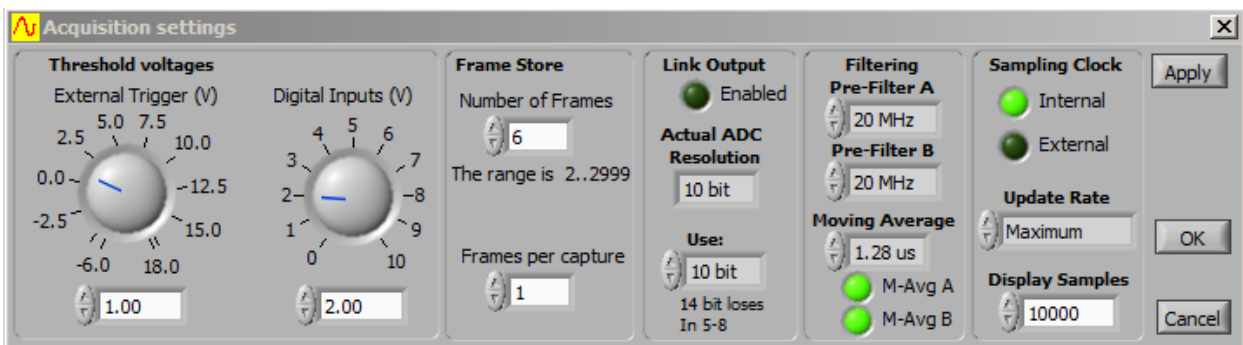

Threshold voltages

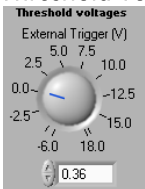

The External Trigger Threshold can be set to any level (at increments of 12.5 mV) between -6 and 18 volts by dialling, typing or nudging the voltage up and down.

External Trigger

Digital Inputs(V)



The level that determines when a digital input is read to be a '1' as opposed to a '0'. The digital input threshold can be set to be any voltage between 0 and 10 volts in 10mV increments.

Frame Store

Samples can be allocated to a single frame or can be divided among multiple frames. This is so that a history of previously captured frames can be recalled or so successive trigger events can be captured with a minimal 20 μ sec inter frame delay.

The Cleverscope acquisition unit can store up to 4 million samples of signal data per channel (8 million if the 8M upgrade is installed).

Number of Frames



Sample storage is allocated evenly between the Number of Frames defined, which can be up to 3000.

If 3000 frames are defined then each will contain 1300/2600 (4M/8M) samples.

Frames per capture

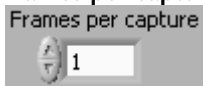

Click on the up and down arrows or in the field to enter the required number of frames per capture to determine how many of the Number of Frames stored are updated on each capture.

The Frames per capture must always be 1 less than the Number of Frames stored.

Example: if the Number of Frames is 50 and the Frames per Capture is 20, every time you click Single, 20 frames will be captured. Each frame will wait until the next trigger occurs before being recorded.

This is useful, for example, to capture 20 serial data messages, so they can be decoded when you look at them.

Link Output

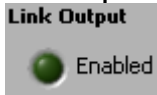

Used for 4 channel sampling by linking two units with a CS1020 2 Port Link Cable via the outputs on the rear panels

To Enable

Click on the Enabled light to on.

To use the LINK output for serial communications select Enabled light to off. You must have the CS1020 link cable connected between the two Cleverscopes for this to work.

Triggering with Link Output Enabled

If you use the Link Output enabled, use normal triggering on the master Cleverscope application, and set the trigger source to Link on the slave Cleverscope application.

You can run two Cleverscope applications at the same time by copying Cleverscope.exe and renaming the copy to something else – e.g. Cscope 2.exe.

Actual ADC Resolution



You can determine the resolution to transfer signals in independent of the ADC used.

If the 12 bit resolution is chosen you cannot display the External trigger on the digital inputs.

If you have the 14 bit resolution selected, you cannot display the External Trigger or Digital Inputs 5-8.

You can still trigger on the External Trigger and Digital Inputs 5-8 however.

The storage used for these inputs is re-used for the extra analog bits. As well as the used sampler resolution, the **Actual ADC Resolution** installed is shown.

Filtering

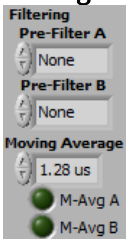

Pre-filter A
Pre-Filter B

You can use either or both of a 20 MHz pre-filter and a moving average filter (with time constants from 40ns to 1.28us) in the incoming signal stream when the **Filter** button on the **Cleverscope Control Panel** is turned on.

Moving Average

The moving average filter can be used to reduce noise in a mathematically optimal way. The noise reduction occurs at the expense of bandwidth.

M-Avg-A

The moving average filter outputs the average of a moving window of the last 4 to 128 samples. It averages all the samples in a moving window the chosen time constant wide. The filter works with the raw 100 Msample/sec input signal stream. So, for the 1.28us wide window, the filter takes the last 128 samples (at 10ns intervals), averages them, and outputs the averaged sample. Then it advances one sample, and repeats. The filter includes time compensation to ensure the delay through unfiltered and filtered signal paths is the same.

M-Avg-B

Note You will see resolution enhancements if you use the filters or the waveform averaging **Display Method**. If you are using the front-end filter you are able to achieve better resolution than the fitted sampler.

Update Rate

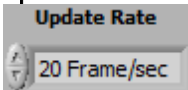

select one of the following:

- 5 Frames/sec
- 10 Frames/sec
- 20 Frames/sec
- .maximum

can be set to 20, 10 or 5 Frame/sec. This is useful to reduce processor load in slower PC's.

Sampling Clock

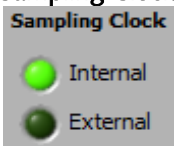

An external clock option is available

Default indicates internal clock

click on **External**. (accepts click even if no external clock fitted)

Display Samples

Used to set the number of samples displayed on a graph. Useful for achieving a desired display sample rate. The default is 10,000. As an example, with a 200msec wide display, 8820 samples will yield the CD sampling rate of 44.1 kHz. The closest resolution allowed by the 10ns decimation will be used.

Chart Sample Rate

Click in the field to enter the sample rate in Seconds, - only in application 4.700 +. You can use m=milliseconds u=microseconds n= nanoseconds

Space available for storage

Cleverscope assesses available storage

Estimated storage time remaining

Cleverscope calculates an estimate

5.3.7 Choose Acquirer and Set Connection [Settings Menu]

Acquirer and interface selection

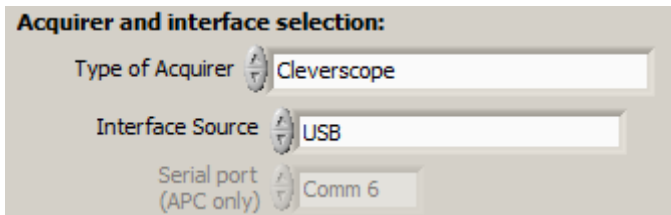

Type of Acquirer

Select one of the options from the dropdown list. The default is 'Cleverscope'.

Note: The **Interface Source** options are greyed out or activated according to the **Type of Acquirer** selected. Some acquirer options do not need a connection set and the panel remains blank.

To evaluate or demo the application use 'Simulated Sig Gen'. To exit demo mode or evaluation mode, use 'Cleverscope'.

Interface Source

Select one of the options if activated.

Remains greyed-out if not required for the **Type of Acquirer** selected. The default for Cleverscope is USB.

Serial port (APC only)

Only activated for APC.

Simulated Sig Gen

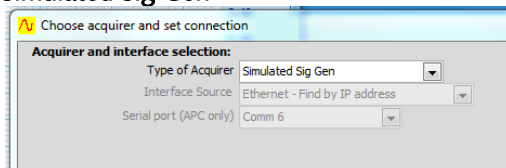

No **Interface Source** required.

Refer to section on the Simulated Signal generator

Cleverscope USB

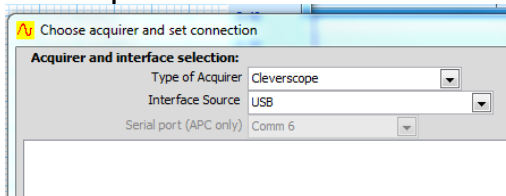

USB port specified at time of ordering/purchase

The **Interface Source** of USB has no other options.

USB - Transfer rate of 18 Mbyte/sec for Cleverscope firmware versions 6435 and above.

Cleverscope Ethernet

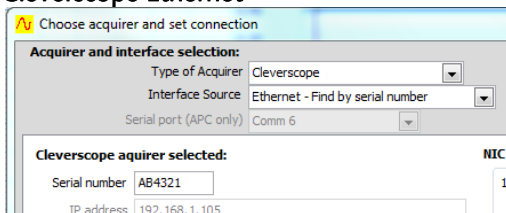

Refer below for Ethernet **Interface Source** options.

Ethernet - Transfer rate of 5MByte/s.

Soundcard,

No **Interface Source** required.

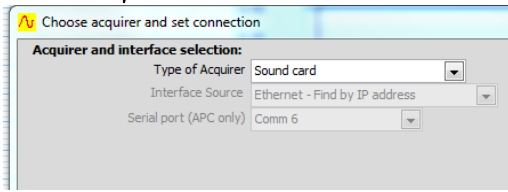

APC901, and APC901A

Select serial port that the Strobes APC hardware is connected to from the list of Com ports in the **Serial port (APC only)** dropdown.

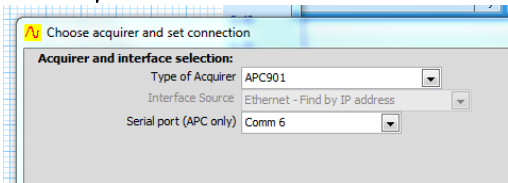

Cleverscope Ethernet

See section 23 Using the Ethernet Cleverscope for a step by step tutorial. The Ethernet port is normally specified at time of ordering/purchase.

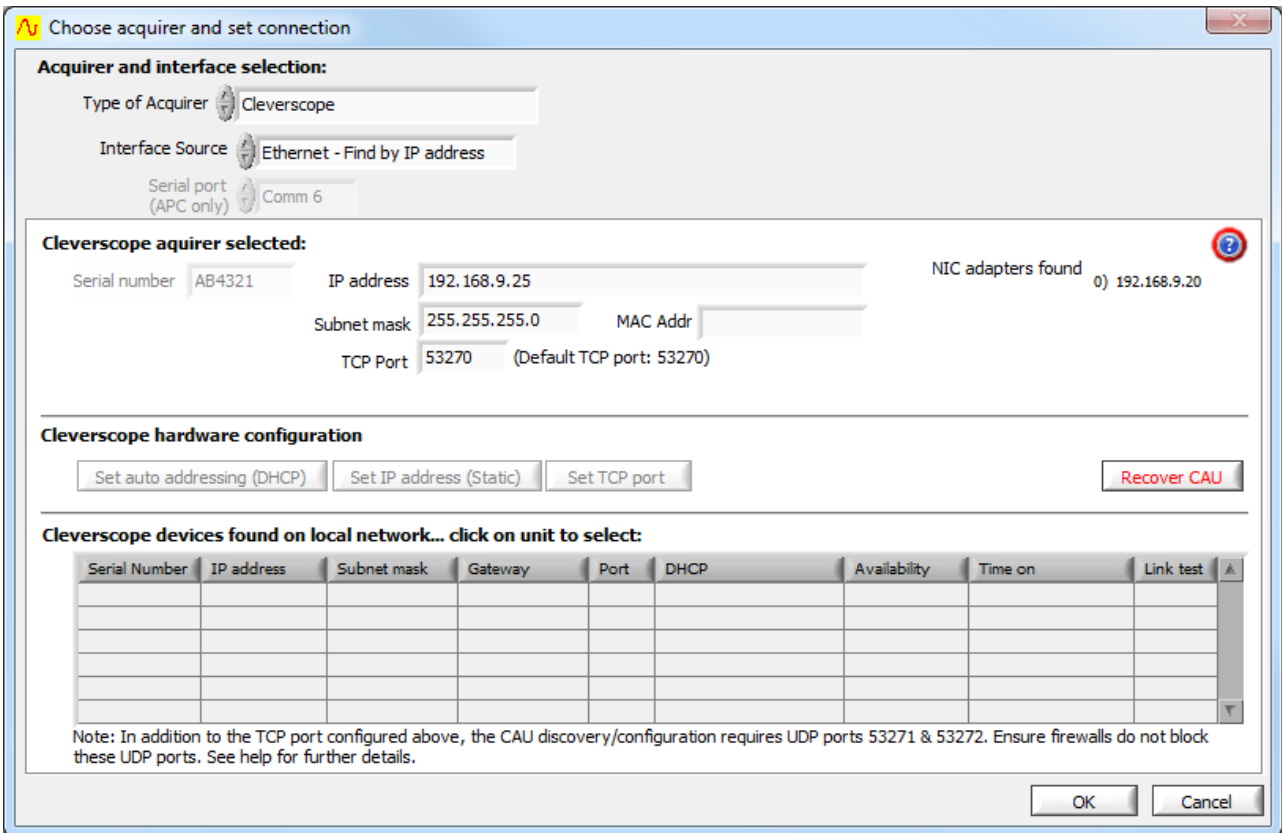

The Ethernet **Interface Source** selections are Find by IP Address, Find first IP Address, or Find by serial number. The Ethernet interface runs at about 5 Mbyte/sec. The Ethernet interface supports DHCP and specified IP addressing. The Ethernet interface has a MAC address assigned

The Ethernet Cleverscope can be connected to a 10/100 Mbit/sec Ethernet network via an Ethernet connector that automatically senses the speed (10 or 100 Mbit/sec) and automatically reverses Tx and Rx if the Ethernet

cable has been crossed over.

No cross-over cable is required for connecting a Cleverscope to a PC Ethernet port.

The Cleverscope can be operated with either a Fixed IP address or as part of a DHCP network (Dynamic Host Configuration Protocol), in which case it will automatically acquire an address in the correct internet protocol address range.

The simplest use is as part of a DHCP network. Most modern routers and all servers offer a DHCP server function.

You can also use Fixed IP (Internet Protocol) Addressing, which is useful when you do not have a DHCP server, or are connecting to a remote Cleverscope connected at some other location.

Cleverscope Ethernet relevant items

The Cleverscope is set by default to work as part of a DHCP network.

When it is plugged into a network, the two lights on the Ethernet connector show status

The **Connected LED** shows that the Cleverscope has connected to the network. The **Transmit/Receive LED** will flash whenever packets of data are transferred. Once the Cleverscope has triggered, the **Transmit/Receive LED** will flash once per second, as the Cleverscope application polls the Cleverscope to make sure it is still connected

If the **Connected LED** is not on, there is a problem, and the Cleverscope will not talk to the Cleverscope application. Please resolve the connection first.

The Cleverscope acquire selected section

Serial Number The serial number is only required if you use the Find by Serial Number option. The serial number can be found on the CAU back label.

The panel includes values for the following:

| | |
|---------------------------|--|
| IP Address | This will be reported after clicking on the Cleverscope to connect to in Cleverscope devices found on the local network. For fixed IP addressing, it is the IP address to use. |
| Subnet mask | Leave this as is. |
| MAC | This is the reported MAC address |
| TCP Port | This is the TCP port used for communications. The default is 53270. |
| NIC Adapters found | Reports any PC NIC adapters found. If there are more than one, and the Cleverscope is not connected to the master, the CscopeUDPSERVICE.exe will be run to share UDP messages over all the adapters. |

The Cleverscope hardware configuration section

The panel buttons are used to choose the type of connection used by the connected Cleverscope Acquisition Unit (CAU), and are as follows:

| | |
|-----------------------------------|---|
| Set Auto addressing (DHCP) | Click the button, with a CAU selected, and the CAU will be programmed to use DHCP addressing for all further connections. |
| Set IP address | Click the button, with a CAU selected, and the CAU will be programmed to use a Static IP address, using the IP address value entered in the <i>Cleverscope acquirer selected</i> section. |
| Set port | Click the button, with a CAU selected, and the CAU will use the TCP Port given for further TCP transactions. |

Cleverscope devices found on LAN display zone

The panel will report values for all connected CAU's. Click on a CAU line to select it. Each CAU has an entry for the following:

| | |
|----------------------|--|
| Serial Number | The CAU Serial Number |
| IP address | The current CAU IP address (might be assigned by DHCP or manual) |
| Subnet mask | The current Subnet mask |
| Gateway | The Gateway IP address used (when connecting outside a LAN). |
| Port | The TCP Port used for TCP transactions. |
| DHCP | States if the CAU is using DHCP or static addressing |
| Availability | Shows the CAU as available or not. If not, it is probably being used by another Cleverscope application. |
| Time on | The total time the CAU has been on. |

5.3.8 Acquirer Scaling [Settings Menu]

Acquirer Scaling

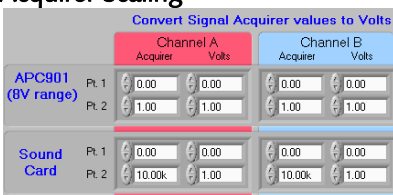

The **Convert Signal Acquirer values to volts** zone defines scaling and offsets to be applied to measurements made by the Strobes hardware (901 and 901A) and soundcards to compensate for any difference between volts as read by the acquirer and any associated input circuitry and the actual volts at the input.

Straight line XY Plot

An X/Y plot showing the linear relationship between the actual volts at the input and the measurement in volts as made by the acquirer must be a straight line.

Pt. 1 and Pt. 2



Define the X/Y straight line, and therefore define the scaling and offset to ensure that the volts as read in Cleverscope are the same as the actual volts present at the input.

For example, if by measurement the acquirer reads 10mV for a real 23 mV signal and 1.2 Volts for a real 1.1 Volt signal, then **Pt. 1** and **Pt. 2** should be as shown on the right.

5.3.9 Spectrum (Ctrl+F) [Settings Menu]

Define Spectrum Parameters

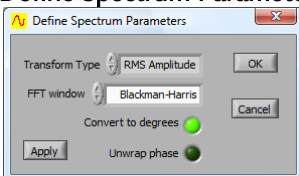

You can select the type of Fourier transform to be applied, the windowing technique to be used, whether phase information is plotted in degrees or radians, and whether Phase should be plotted between -180 and 180 degrees or 0 to 360 degrees.

Transform Type



Click on the arrows or in the field to select from the dropdown list.

Options are: RMS Amplitude, Power, Power Density, or Gain/Phase.

RMS Amplitude

Returns the magnitude of a signal in volts.

RMS amplitude is the most common type of Fourier transform. The RMS (root mean square) voltage for each frequency bin is displayed. This value is equivalent to a continuous sinusoid at the bin frequency with RMS amplitude equal to that displayed. The RMS value of a sinusoid is a

constant voltage equal to the sum of each squared instantaneous voltage value divided by the time over which the sinusoid is measured.

Power

Returns the magnitude of the power content of an equivalent continuous periodic signal at the bin frequency. Assuming a voltage input, **Power** spectrum represents the power dissipated at each frequency bin into a one ohm resistor. The **Power** spectrum can be scaled by setting the 0 dB reference level.

Example: let the reference value be 1W dissipated in a 50 ohm load:
 From $P = V^2/R$, $V = \sqrt{PR} = \sqrt{1 \times 50} = 7.07 \text{ V}$.
 Therefore, set the reference level to 7.07 V.

Power Density

returns the magnitude of the power spectral density.

This is the power content of an equivalent continuous periodic signal at the bin frequency divided by the frequency width of the bin. The reference is used as for **Power** spectrum.

Gain/Phase

Assumes that Channel A is connected up to the input of a system under test and that Channel B is connected to the output of the system. By performing a Fourier analysis on frames of signal data representing the input and output of a system, gain versus frequency and the phase versus Frequency can be plotted for the system under test.

The gain plot is presented as Channel A and the phase plot replaces Channel B. Gain is plotted in either dB's or in linear units of gain depending on whether you have selected **Display in dB's** see below).

Convert to degrees

Convert to degrees 

Click button to set the phase plot to degrees or radians

Unwrap Phase

Unwrap phase 

Click button to set the phase plot between 0 and 360 degrees instead of the default plot between -180 degrees and +180 degrees.
 Avoids discontinuities at 180 degrees (π radians).

FFT Windowing Technique

Windowing is a mathematical technique used to minimize **end-point errors**

Fourier analysis makes the assumption that the sampled section of a waveform as captured in a frame is repeated infinitely both forward and backward in time. Using the special case of a sine-wave to illustrate the point, a captured sine wave will not necessarily finish in the frame at the same point in its cycle that it started.

Assuming that such a frame is repeated endlessly will therefore add discontinuities where the frames join that are not actually present in the real signal. These discontinuities are called **end-point errors** and they are common to all Fourier Transform Analysers..

Point Errors

FFT Window

FFT window  Blackman-Harris

Click on the arrows or inside the field to select a windowing technique from the dropdown list.

Options are None, Hanning, Hamming, Blackman-Harris, Exact Blackman, Blackman, Flat top, 4 Term B-Harris, 7 Term B-Harris, Low Sidelobe

FFT Window Characteristics

This table shows the performance of each window in terms of lobe width for a single frequency. Each bin corresponds to the frequency resolution available.

| Window | -3 dB Main Lobe Width (bins) | -6 dB Main Lobe Width (bins) | Maximum Side Lobe Level (dB) | Side Lobe Roll-Off Rate (dB/decade) |
|-----------------|------------------------------|------------------------------|------------------------------|-------------------------------------|
| Uniform (None) | 0.88 | 1.21 | -13 | 20 |
| Hanning (Hann) | 1.44 | 2.00 | -32 | 60 |
| Hamming | 1.30 | 1.81 | -43 | 20 |
| Blackman-Harris | 1.62 | 2.27 | -71 | 20 |
| Exact Blackman | 1.61 | 2.25 | -67 | 20 |
| Blackman | 1.64 | 2.30 | -58 | 60 |
| Flat Top | 2.94 | 3.56 | -44 | 20 |

Example FFT Window selection

The choice of window to use depends on the type of signal being examined, and the desired trade-off between Frequency resolution, spectral leakage and amplitude accuracy.

The following table gives a first approximation to the best type of window to use:

| Signal Content | Best frequency resolution | Best spectral leakage | Best amplitude accuracy |
|---|---------------------------|-----------------------|-------------------------|
| Sine wave or combination of sine waves | Hanning | Exact Blackman | Flat Top |
| Narrowband random signal (vibration data) | Hanning | Blackman Harris | Blackman Harris |
| Broadband random (white noise) | Uniform (None) | Blackman | Uniform |
| Closely spaced sine waves | Uniform, Hamming | Hamming | Blackman |
| Excitation signals (Hammer blow) | Uniform (None) | | |
| Unknown content | Hanning | | |

5.3.10 Averaging.(Ctrl+A) [Settings Menu]

Averaging can be used with either the **Spectrum Display** or the **Scope Display/Tracking Display**.

Define Averaging Values

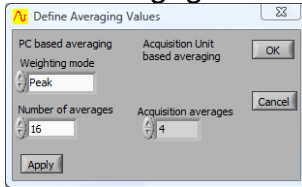

A number of frames can be arithmetically averaged together to reduce the effect of noise.

Averaging is usually used to minimize the effects of noise and to find the average value of a signal in the presence of noise.

Weighting mode

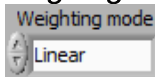

Click the arrows or in the field to select from the dropdown list.

Options are: **Linear**, **Exponential**, or **Peak**.

Linear

Linear averages with equal weighting. It sums a number of captured frames and then calculates a new frame which is the average of them all. The number of frames being averaged may be set in **Number of averages**.

Triggering can be used to ensure that all of the averaged frames are aligned with respect to the cycle of the captured signal.

Example: If 16 frames are being averaged then a new frame is displayed only after 16 frames have been captured, transferred and averaged.

Exponential

The PC calculates the average for a new frame every time a frame is captured and transferred from the acquisition hardware. Automatic frame capture, triggering, and frame transfer will continue to work as it does without averaging. Triggering can be used to ensure that all of the averaged frames are aligned with respect to the cycle of the captured signal.

Older frames contribute less than more recent frames to each calculated average. The contribution of a frame to each new calculated average diminishes exponentially with time as new frames are transferred and new averages calculated. The contribution of older frames to the most recently calculated average is never lost however (unless averaging is turned off or reset).

Peak

Note: **Peak** averaging can only be applied to the **Spectrum Display**.

Peak averaging is useful where you want to accumulate in one spectrum the maximum frequency points from the spectra of a number of frames. **Peak** averaging can only be used to accumulate the peak frequency levels from consecutive spectra and is not relevant for use in the time domain.

When **Peak** averaging is used the spectrum of a frame of signal data is calculated and the frequency points are saved in an averaging array. When the frequency points of a newly captured frame are loaded into the averaging array only those points whose levels are both greater than their counterparts in the current array are actually loaded. In this way all the frequency points in the peak averaging array represent the greatest levels so far recorded at those points.

Peak averaging is also useful if you are doing **Gain/Phase** plots. Instead of using a white noise generator to produce an input signal that contains all the frequency points of interest in one frame, a sweep frequency signal generator can be used to build up the gain and phase response of the system over a number of frames.

Note The choice of **Number of averages** is not relevant for **Peak** averaging.

| | |
|-----------------------------|--|
| Number of Averages | Enter a number to define the number of frames to be included in the averaging calculation. |
| Acquisition averages | Click the up or down arrow to cycle through the list or click in field to select from the dropdown list. Options are preset values 4, 16, 64 or 128 . |

5.3.11 Example: **Exponential averaging**

Let N represent the **Number of averages** when exponential averaging is selected. The value of a sample in a newly averaged frame is calculated as follows:

The value of a sample in a new frame is added to N-1 multiplied by the value of the equivalent sample in the last 'averaged' frame and the total is divided N.

$$V_{\text{newcalc}} = (V_{\text{new}} + (N-1)V_{\text{previouscalc}})/N$$

Where V_{newcalc} , V_{new} , $V_{\text{previouscalc}}$, all represent samples which are in equivalent positions in a frame with respect to time and:

V_{newcalc} is the newly calculated average for a sample.

V_{new} is the most recently measured and transferred value for the equivalent sample.

$V_{\text{previouscalc}}$ is the previously calculated average for the equivalent sample.

This form of averaging is called exponential averaging because the weighting given to each frame of samples, as you go back in time, represents an exponentially decaying curve. If N is 4 the weighting given to the samples in each frame going from the most recent frame backwards is represented by the following series:

$$V_1 1/4, V_2 3/16, V_3 9/64, V_4 27/256, V_5 81/1024 \dots$$

Where V_1 is the amplitude of a sample in the most recent frame and V_5 is the amplitude of the equivalent sample in the 5th most recent frame.

Averaging in the Scope Display

If you wish to do time averaging, you must have a periodic waveform whose phase variation is relatively stable so you achieve a stable trigger.

Use equal averaging when all frames are equally important (a periodic waveform with noise, for example). Use exponential averaging when you wish to get the best estimate of the current value of a varying signal (for example a pulse train with jitter).

Averaging in the Spectrum Display

If you wish to do frequency domain averaging then you should be aware of the difference that Triggered and Auto frame capture has on averaging. If Triggered has been selected, Cleverscope assumes you have a periodic waveform and a good trigger, and averaging will be performed in the time domain, before transforming the resulting average to the frequency domain. If Auto is selected, the signal data is transformed and the averaging is performed in the frequency domain.

Use Triggered when you have a stable periodic signal with impressed random noise. Use Auto when the signal is not periodic and a stable trigger is not available. When Auto is used (and averaging is done in the frequency domain) endpoint errors will be smoothed as they will have different frequency content from frame to frame. End-point errors are discussed under 'Windowing' above.

5.3.12 **Reset Average (Ctrl+R) [Settings Menu]**

Reset Average Click the button to restart any averaging process that may be underway.

The averaging process that is currently selected will start again when the next frame is captured

5.3.13 *Display in dB [Settings Menu]*

Display in dB Click button to set the vertical axis of the **Spectrum Display** to display logarithmically in dB instead of linear.

This menu option will show as "ticked" after being selected

Note: The exception to this is the Phase plot when **Gain/Phase** is selected for the **Spectrum Display** because phase is always graphed in degrees or radians.

5.3.14 *Display spectrum log frequency [Settings Menu]*

Display spectrum log frequency Click button to set the horizontal axis of the **Spectrum Display** to display logarithmically instead of linear

5.3.15 Calibrate Cleverscope [Settings Menu]

The Cleverscope provides calibration tools to ensure measurements are correct.

Standard Calibration

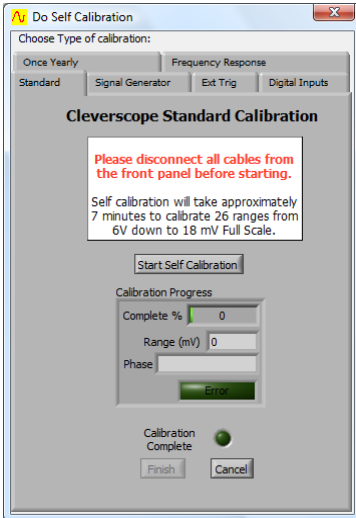

Standard self-calibration should be executed if the temperature changes by more than 10°C. Cleverscope includes an internal reference which is used to self-calibrate all the analog circuitry within the **Cleverscope Acquisition Unit**. Before initiating a **Standard** self-calibration, disconnect all probes from the front of the **Cleverscope Acquisition Unit** and ensure that it has been powered up for more than 5 minutes, then click **Start Self Calibration**. The self-calibration process takes about 7 minutes.

The **Signal Generator** calibration only needs to be done once after you install the optional **Signal Generator Unit** yourself. If your **Cleverscope Acquisition Unit** came with a **Signal Generator Unit** installed then this calibration will have been completed at the factory. Before initiating a **Signal Generator** calibration, connect a lead from the **Signal Generator** output to the **Chan A** input, and then click **Start Sig Gen Calibration**.

Once Yearly

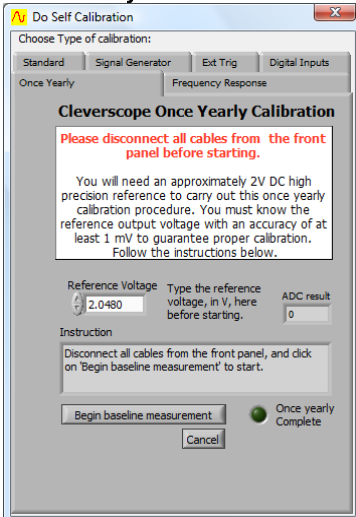

The **Once Yearly** calibration requires a high precision reference of around 2 V. You must know the reference output voltage with an accuracy of at least 1 mV to guarantee proper calibration. Before initiating a **Once Yearly** calibration, disconnect all probes from the front of the **Cleverscope Acquisition Unit** and ensure that it has been powered up for more than 5 minutes, then click **Begin baseline measurement** and follow the instructions. A **Once Yearly** calibration should always be followed by a **Standard** self-calibration.

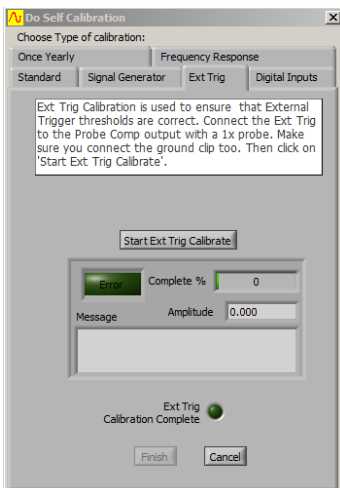

The **Ext Trig** and **Digital Inputs** calibration only needs to be done once. If the thresholds for the external trigger or digital inputs are not responding correctly then perform the appropriate calibration. Earlier versions of the Cleverscope acquisition unit may not have had this done at the factory.

The **Frequency Response** calibration is completed at the factory. If you think there is a problem with the frequency response of your **Cleverscope Acquisition Unit**, contact Cleverscope support before carrying out a **Frequency Response** calibration.

5.3.16 Colours [Settings Menu]

Setup Colours lets you select different colours for graph plotting to match your corporate image or make them easier to see.

You can set colours for channel A plot, channel B plot, graph backgrounds, and major and minor grid lines for the active display indicated in the **DISPLAY** area of the Cleverscope **Control Panel**.

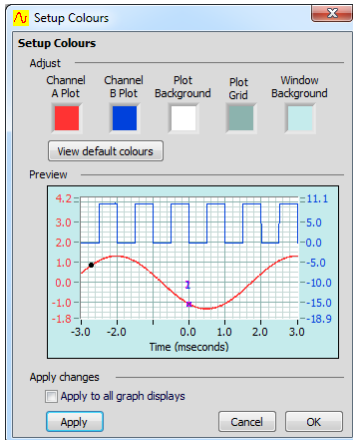

Adjust

Click in each colour box and select a new colour from the colour picker pop-up dialog.

Preview

The **Preview** displays the colour changes before they are applied to the Cleverscope displays.

Use default colours

Restores the manufacturer's default colour set.

Apply to all graph displays

Click the checkbox so all displays will be updated.

5.3.17 Display tool tips [Settings Menu]

Display tool tips

Click to select whether the tool tip pop-ups show when you hover the cursor over an item.

Menu option will show as 'ticked' when selected. There is no dialog associated with this menu option.

5.4 View Menu [Control Panel]

View menu allow you to set which displays are active.

Note: The **Digital Inputs** is not a separate window, but is built into the **Scope Display** or **Tracking Display**. The **Digital Inputs** display can be de-selected to save screen space.

Note: the **Scope** display is always active although it can be resized or minimised but not closed.

View Menu

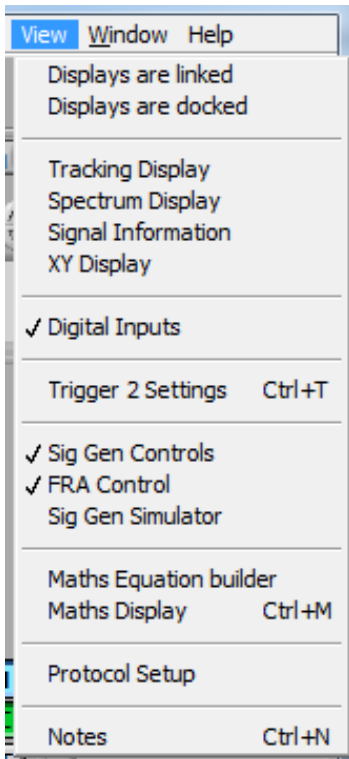

| | |
|-------------------------------|--|
| Displays are linked | Connects scope display signals to other displays. |
| Tracking Display | used with the Scope Display for a close-up view. |
| Spectrum Display | displays the signal spectrum. |
| Signal Information | displays signal statistics. |
| XY Display | displays an XY plot of Chan A against Chan B. |
| Digital Inputs | displays digital input lines and external trigger. |
| Trigger 2 Settings | sets Trigger 2 parameters. |
| Sig gen Controls | sets signal generator output (waveform, frequency, level). |
| FRA Control | sets up test parameters for frequency response measurement |
| Sig Gen Simulator | provides controls for the virtual built-in signal generator. |
| Maths Equation Builder | build equations to process signals. |
| Maths Display | display Maths Equation Builder results. |
| Protocol Setup | See section XXX Protocol Setup |
| Notes | Notes can be added to displays. |

5.4.1 Displays are Linked

Displays are Linked

Click to link the tracer in the **Scope Display** to mimic the tracer in the **Tracking Display**, and vice versa.

The menu option will show as 'ticked' when selected. There is no dialog for this menu option.

Note The **Tracking Display** time axis will change to keep the tracer in the centre of the graph.

Note If the **Tracking Display** is not linked, the two graphs can be manipulated independently of each other.

5.5 Window Menu [Control Panel]

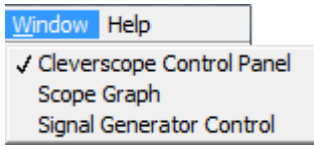

Click on one of the Cleverscope displays listed in the menu to bring it to the front

Note: Displays in the Window menu are only listed if they have already been selected in the **View** menu

Note: A window can also be made active by simply clicking inside it, but this presumes that it is visible, or in front on the desktop.

5.6 Help Menu [Control Panel]

About Cleverscope

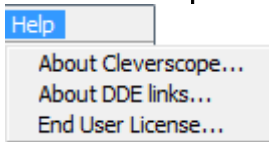

Click to display the various keyboard shortcuts and the current version number of the Cleverscope Application software you have installed

Note You can copy the keyboard shortcut control list from the **About Cleverscope** window and paste wherever it is helpful for you.

About DDE links

Click to display DDE (Dynamic Data Exchange) link information if you want to link live data from Cleverscope to other applications such as Microsoft Excel or Access.

End User License

Click to display the License Agreement.

6 Scope Display [View Menu]

The Scope Display is the primary window and is always selected for display but can be minimised, It includes the Digital display which can be optionally hidden

Scope Display Zones

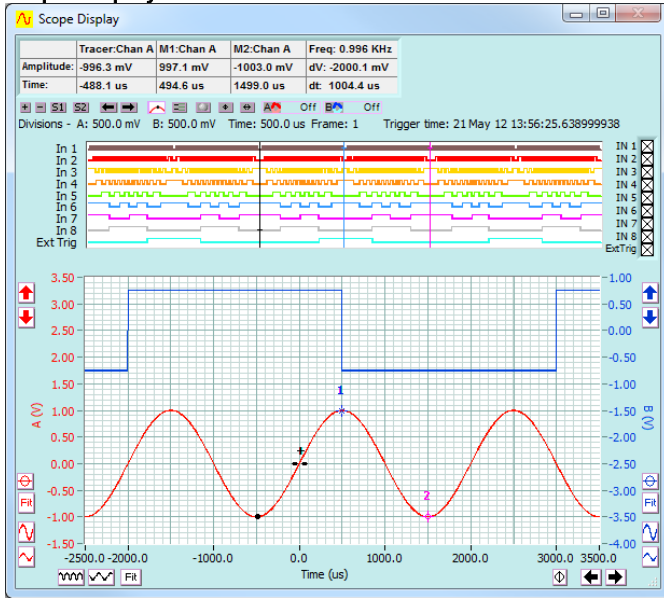

Signal Information Zone

Tools Zone

Digital Inputs Zone

Analogue Display Zone

Displays captured signals in the time domain and to determine the boundaries of the signal to be captured in both amplitude and time.

Signal Information Zone

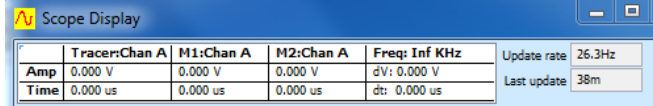

Displays a real time view of incoming signal data.

Digital Inputs Zone

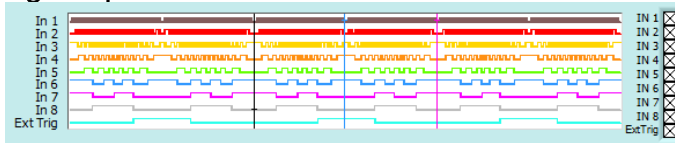

Digital Input pulse trains are displayed, one on each of the 8 digital inputs.

Analogue Scope Zone

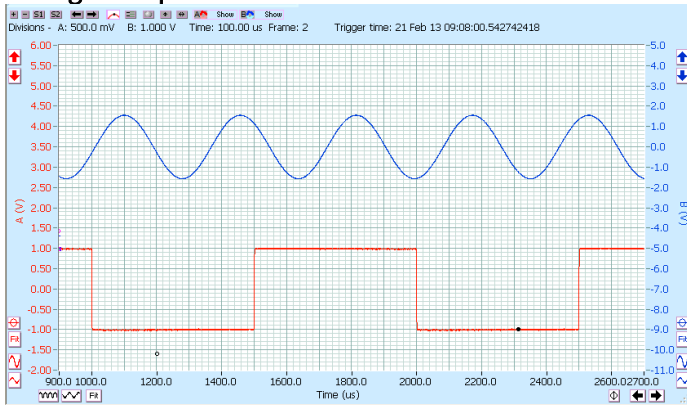

Displays the signal with channel A and B signal traces positioned one above the other and both visible in the same window.

Channels A and B are both referenced to the same horizontal time axis but each has their own vertical or voltage axis.

The **Tools Zone** contains Display specific tools. These are described in detail in section 10.7.

7 Tracking Display [View Menu]

The **Tracking Display** is used in conjunction with the **Scope Display** to give an overview of the entire frame of signal data plus a close-up view of a portion of the signal trace that interests you.

Tracking Display



Click on the **View** menu and click on the **Tracking Display**.
Click on the **View** menu click on the **Displays are Linked**.

7.1 How the Tracking Display Works

As you move your mouse along the signal trace in the **Scope Display**, the **Tracking Display** window will also move and give a close-up view of the signal centred on the position of the tracer in the **Scope Display**. The tracer positions in both graphs will refer to the same point. (With *View/Displays are linked* ticked).

The **Tracking Display** zoom, pan, and annotate, work the same way as in the **Scope Display**. The **Tracking Display** has its own markers and annotations.

As you move the mouse/tracer outside the current window view in the **Scope Display**, the tracking window will move to accommodate the new tracer position. This ensures that the tracer is always in view.

As with the **Scope Display**, when **Digital Inputs** is selected on the **View** menu, the **Tracking Display** also displays the **Digital Inputs**.

There are many occasions where you find a feature of interest in the **Scope Display** and wish to examine it more closely. To do this, position the tracer on the feature in the **Scope Display**, type 'L' to temporarily lock the **Tracking Display** position. You can now manipulate the **Tracking Display** view.

Click on the **Tracking Display** to clear the lock.

As with the **Scope Display**, the **Tracking Display** has an **Information** zone that displays information about the position of the **Tracking Display** tracer, markers, marker differences, and signal frequency. The Tools Zone is used for Display Specific commands.

8 Spectrum Display [View Menu]

The **Spectrum Display** displays the Fourier transform of the channel A and channel B signal data. The **Source** for the **Spectrum Display** can be selected from the **Scope**, **Tracking** or **Maths** display.

Spectrum Display

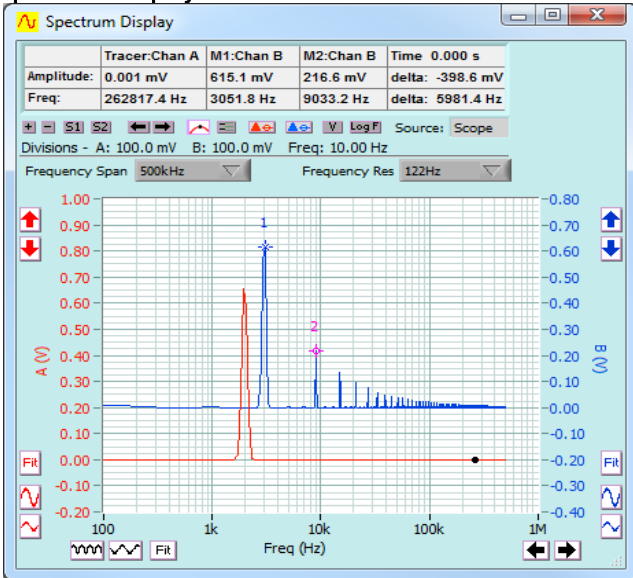

Click on the **View** menu and click on the **Spectrum Display**.

The channel A button is shown in the *set peak to 0 dB* position and the channel B button is in the *normal* position.

The Spectrum display has added Tools which are specific to it.

Spectrum Graph Tools

Set Chan A peak to 0 dB Click to toggle channel peak value to 0dB as displayed on the graph.

Set Chan B peak to 0 dB Click to toggle channel peak value to 0dB as displayed on the graph.

Y Scale - Voltage/dB Click to toggle between Voltage and dB scales.

Freq Scale Click to toggle between linear and log scales.

Source Click to select Scope, Tracker, or Maths as the signal source for the Spectrum display.

Frequency Span Click on the button and select the spectrum analysis frequency span for the **Spectrum Display**.

Frequency Res Click on the button to select the spectrum analysis resolution for the **Spectrum Display**. The resolution is increased by increasing the number of samples returned from the capture unit to the spectrum analyzer.

Cleverscope allows a spectral resolution of 1 part per million and supports a frequency resolution limited only by the sampling duration (Tdur) and sampling interval (dT). By balancing dT and Tdur, appropriate choices for Frequency Span and Resolution to make best use of the deep memory sample buffer can be made. Increasing Tdur increases Frequency Resolution.

Note When selecting a reduced frequency span you need to be aware of aliasing. Reducing the frequency span essentially samples the signal at a lower rate. If frequency components above half the effective sample rate are present, these will alias (or fold) back into the displayed spectra.

Spectrum Dialog

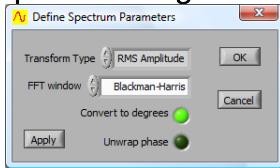

Refer to Settings/Spectrum Menu.

The Spectrum Dialog is used to control aspects of the Spectrum Display.

8.1 Spectrum Display Tracer and Markers

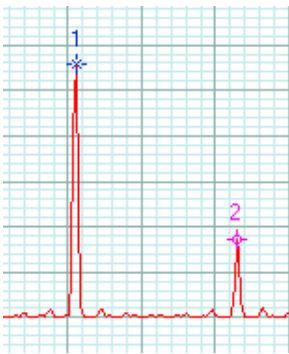

As with the **Scope Display** and **Tracking Display**, the display controls for the **Spectrum Display** work the same way, except that the horizontal axis represents frequency instead of time.

A tracer may be moved along the spectrum trace in the same way as the **Scope Display**.

Markers may be placed on the spectrum trace at points of interest by double clicking at the desired tracer position.

| Tracer:Chan A | Mark 1:Chan A | Mark 2:Chan A | Time 0.000 s |
|---------------------|---------------|---------------|-------------------|
| Amplitude: 7.384 mV | 2780.7 mV | 883.2 mV | delta: -1927.6 mV |
| Freq: 0.000 KHz | 1.107 KHz | 3.288 KHz | delta: 2.181 KHz |

The **Information** area displays information about the position of the tracer, the markers, the amplitude and frequency differences between the markers and the inverse frequency difference between markers, labelled as time.

9 Cleverscope Displays – Display Control Buttons

Use the buttons around the graph, and the tools above the graph to control the display view.

9.1 Display Buttons - Vertical Axis

Buttons common to Scope, Tracking, Spectrum, XY, and Math displays

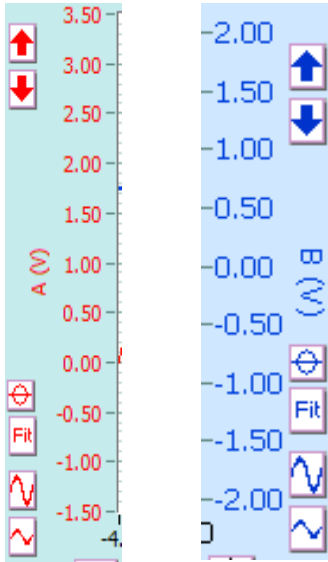

The Red Buttons to the left of the A channel vertical axis control A channel vertical settings.

The Blue Buttons to the right of the vertical B channel axis control Channel B vertical settings.

The vertical axis settings determine the internal scaling and offset.

Cleverscope's full 10-14 bit analog resolution maps onto the chosen minimum and maximum amplitude axis values to maximize resolution.

The values for Channels A and B are independent of each other.

The **Scope Display** setup specifies the Channel A, Channel B and Time settings used to capture the signal.

  Vertical Up

Click button to move a channel signal trace up on the display.

  Vertical Down

Click button to move a channel signal trace down on the display.

  Zero

Click to set the amplitude axis so that 0V is at the vertical centre of the amplitude range.

  Fit

Click  to change the amplitude axis to fit the available signal. Channel A is placed on the lower half, and Channel B on the upper half, of the graph.

  Vertical Expand

Click to increase the height of the signal on the display.

  Vertical Contract

Click to reduce the height of the signal on the display.

9.1.1 Button Vs Keyboard expand/contract

The keyboard shortcuts work on the currently selected Channel. There is an **important** distinction between the wave the buttons work, and the keyboard shortcuts. The vertical expand and contract buttons expand and contract the signal about the centre voltage value, while keeping that point at 1/4 and 3/4 of the amplitude range (Chans A, B respectively). The Keyboard Expand (Ctrl ↑) and Contract (Ctrl ↓) expand and contract about the tracer position. This means the Keyboard shortcuts are very useful for rapidly expanding at the tracer point.

9.1.2 Display Buttons - Horizontal Axis

Buttons common to Scope, Tracking, Spectrum, XY, and Math displays

The horizontal time axis buttons control the positioning and scaling with respect to time of both A and B channel signal traces.

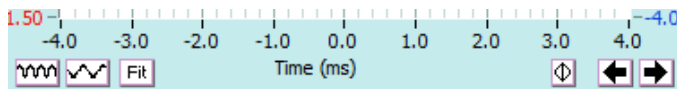

Trigger Position

The trigger position is always time 0.

Time Axis

Determines the start and stop time of the signal captured relative to the trigger (this example has a start time of -4ms and stop time of +4ms. The duration is 8ms.

If you position the time axis so that the left hand side of the axis is negative the display will show the signal before the trigger occurred.

If you position the times axis so the left hand side is positive the display shows only samples after the trigger. The Acquisition unit triggers, and then waits until the time at which the graph starts, and starts recording samples. This period can be up to 20 seconds, without a reduction in resolution.

Horizontal Left

Click  to move the signal left in time.

Horizontal Right

Click  to move the signal right in time.

Horizontal Contract

Click  to contract the signal with respect to time.

Horizontal Expand

Click  to expand the signal with respect to time.

Fit

Click  to change the times axis to fit the available signal.

Zero

Click  to reposition the graph so that the trigger (zero time) is at the centre of the horizontal axis .

Mouse Wheel





Note The mouse scroll wheel acts as a virtual knob using the last action performed on the graph. For example will work on the last control used as a virtual knob.

Note: Cleverscope keeps all the samples in the acquisition unit. When you zoom the graph the Cleverscope application Software requests a new graph view from the acquisition unit. The acquisition unit finds the samples, and returns them, via the USB or Ethernet.

The acquisition unit can keep up to 2M or 4 M samples in any one display buffer (for the 4M and 8M models) if the Number of Frames = 2. You can click **Get Frame** on the Control Panel to move all the samples in the acquisition unit into the PC. Further zooming and panning will then use the samples in the PC.

9.2 Zooming the Graph



Use to enlarge or reduce the graph. For the time axis, the contract button () zooms out on the signal and the expand button () zooms in on the signal. For the amplitude axis, the expand button () zooms in, and the contract button () zooms out.

Graph enlarge/reduce tools

Use to zoom on time, amplitude or both.



← and → move the cursor left and right.

Control Panel Tools

Shift + ← and → move the signal left and right.

Ctrl + ← and → contract or expand the signal in time.

↑ and ↓ move the selected signal up and down.

Key commands

Shift + ↑ and ↓ move the selected signal up and down.

Ctrl + ↑ and ↓ expand or contract the signal in amplitude..

9.2.1 Button Vs Keyboard expand/contract

There is an **important** distinction between the way the horizontal buttons work, and the keyboard shortcuts. The horizontal expand and contract buttons expand and contract the signal about the centre of the graph. The Keyboard Expand (Ctrl →) and Contract (Ctrl ←) expand and contract about the tracer position. This means the Keyboard shortcuts are very useful for rapidly expanding at the tracer point.

10 Cleverscope Displays - Tracers and Markers

10.1 Tracers

The **Tracer** is a small black dot that can be moved along a signal trace using the mouse.

Analog Tracer

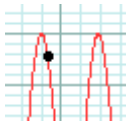

The voltage level and position in time corresponding to the tracer position is displayed in the **Information** area.

Move the tracer to a point of interest on the signal trace or spectrum to read the voltage level and time at that point.

| | |
|-----------|---------------|
| | Tracer:Chan A |
| Amplitude | 790.0 mV |
| Time: | -2.350 ms |

Digital Tracer

A black tracer line on the digital graph follows the analog tracer.

10.2 Setting Analog Markers

Markers are used to measure the time and amplitude of a time plot on the scope and tracking displays or the frequency and amplitude for a spectrum plot.

Number of Analog Markers

2

Set Analog Marker 1

Press the number '1' or Space Bar or double click to set Marker 1.

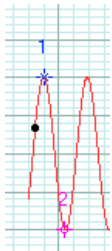

Set Analog Marker 2

Press the number '2' 'Space Bar or double click to set Marker 2.

Analog Marker Position

Displayed in the **Information** area of the display.

| | |
|---------------|---------------|
| Mark 1:Chan A | Mark 2:Chan A |
| 999.8 mV | -987.5 mV |
| -2.500 ms | -1.750 ms |

Analog Marker Trace Position



The markers will always maintain their horizontal positions on the signal trace.

10.3 Digital Tracers and Markers

Digital Markers are vertical lines, synchronized with the analog markers. Line colours are matched to the Analog Marker number colours.

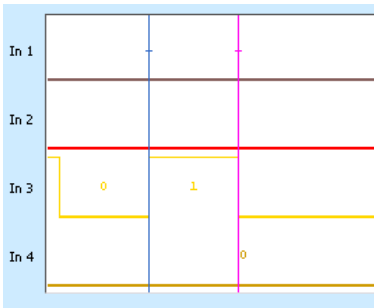
Digital Markers



To examine a digital input, use the cursor tool () to drag the threshold marker  to the input of interest.

10.4 Setting Digital Markers

Digital Markers are set by positioning the cursor in the Analog Display.

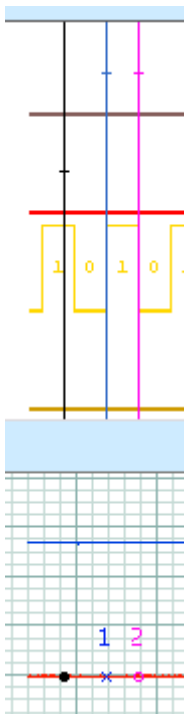

Move the **Tracer** dot in the Analog Display to the first position required in the digital display. A vertical black Trace line in the Digital display is synchronised with the Tracer dot.

Double click (or press the '1' key) to set **Marker 1** (blue) in the Analog Display and the blue-coloured line will be set in the Digital display.

Move the **Tracer** dot in the Analog Display to the second position required in the digital display. The vertical black line in the Digital display will follow the Tracer dot.

Double click (or press the '2' key) to set **Marker 2** (magenta) in the Analog Display and the magenta-coloured line will be set in the Digital display.

10.5 Using Markers to Measure Differences and Frequency

| |
|-------------------|
| Freq: 1333.3 Hz |
| delta: -1987.2 mV |
| delta: 0.750 ms |

You measure differences by placing two markers, and then reading the differences in the right most **Information** box. In the example above the time difference is 0.75 ms. You can measure differences between plots by placing the first marker, and then pressing the **Tab** key to move from one plot to the next, and placing the second marker.

Also displayed in the **Information** area are the differences in voltage and time (delta) between the two markers. The Freq value is the inverse of the time delta.

Divisions - A: 500.0 mV B: 20.00 mV Time: 500.0 us

Volts/Division and Secs/Division for A and B channels are displayed above the top left hand side of the graph.

10.6 Cleverscope Displays - Frame and Trigger Time Stamp

Frame: 2 Trigger time: 19 Mar 13 13:49:28.004999830

Frame gives the Frame number for the graph currently displayed.

Trigger time stamp The trigger time stamp is maintained by the CLEVERSCOPE, as a 64 bit word with 10ns resolution (5,865 years). Each trigger is time stamped with the real time to 10ns resolution.

The trigger time is displayed above the graph on the right, and is also used to time stamp the protocol decodes.

In addition the trigger time can be used by the Maths system to calculate the time difference between triggers.

Any saved files (.apc and text) are time stamped with the trigger time.

Note: You may need to drag the window wider to see the whole time stamp.

10.7 Cleverscope Displays - Graph Tools

Cleverscope has a series of buttons between the graph and the information area that control graph settings.

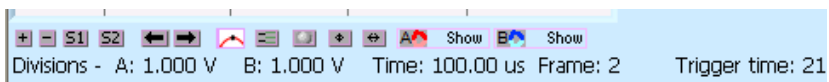

+ **Zoom In** Click **+** button to zoom in on both channels at the same time.

- **Zoom Out** Click **-** button to zoom out on both channels at the same time.

S1 **Setup 1** Click **S1** button to restore graph setup 1.

Click **Shift+S1**) to save graph setup 1.

Click to restore graph setup 1 and 2. **Shift + Setup 1 (S1)** and **Setup 2 (S2)** save graph setup 1 and 2.

S2 Setup 2

Click **S2** to restore graph setup 2. **Shift + Setup 1 (S1)** and **Setup 2 (S2)** save graph setup 1 and 2.

To restore graph setup 1 and 2. **Shift + Setup 1 (S1)** and **Setup 2 (S2)** save graph setup 1 and 2.



Previous Graph Setting

Click to go back to the previous graph setting.

The settings buffer can hold up to 50 previous settings.



Next Graph Setting

Click to go forward to the next graph setting.

The settings buffer can hold up to 50 previous settings.



Tracer Cursor Style

Click to select a **dot** cursor, **vertical line** cursor, **horizontal line** cursor, **floating horizontal line marker** cursors, and **floating vertical line marker** cursors.



For the **floating line marker** cursors use the **cursor tool** () to move them.



Normalize Grid

Click button to normalize the scales of the grid so they line up.



Knob Palette



Click button to turn the **knob palette** on or off.

The **knob palette** will appear in the left-hand side of the **Scope Display** as shown to the right.

mouse scroll wheel

Note The mouse scroll wheel will work on the last control used as a virtual knob.



Y Coarse/Fine

Click to toggle between coarse and fine movement of the Y scale.

= **Coarse** moves by a major grid scale on each movement.

= **Fine** moves by a minor grid scale (1/5th of the major grid) on each movement.



X Coarse/Fine

Click to toggle between coarse and fine movement of the X scale.

= **Coarse** moves by a major grid scale on each movement.

= **Fine** moves by a minor grid scale (1/5th of the major grid) on each movement.

Chart

Click () to toggle automatic scrolling of the graph during charting.

Note: Only available in version 4.7 and above.

11 Persistence

Persistence is used to add a visual history of how the signal has changed over time. It is very useful for seeing the limits of signals and plotting eye diagrams.

Cleverscope supports variable persistence on either channel. In addition a reference feature has been added, which makes it easy to compare a reference waveform to the current waveform.

Cleverscope supports Persistence on the graphing displays for versions 4643 and later.

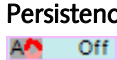
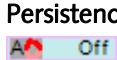
Persistence Controls Each graph has persistence controls for Channel A ( Off) and B ( Off). Each graph has independent persistence.

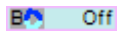

The default state for both controls is *Off*, which disables the persistence system and minimizes processor load.

If you choose any item other than *Off*, the persistence system will turn on for both channels, and the other channel will be set to *Hide*. The persistence system uses considerable processor resources, so if you are not using it, set a channel to *Off*. Setting either channel to *Off* turns the other channel off as well.

Persistence Settings

| | |
|-----------------|---|
| Off | The persistence system is turned off, and all persistence information is lost. |
| Hide | Current persistence values for the channel are hidden, but not lost. |
| Show | Current persistence values are displayed, but not added to by new captures. |
| Clear | Current channel persistence values are cleared. |
| Addref | The current channel plot is added to the persistence plots. You can have up to 50 reference plots per channel. Once added, a reference plot will not be visible until after a new channel plot is captured, because it lies underneath the current channel plot. A lighter version of the current channel colour is used. |
| 10 Trig | The 10 most recent persistence plots will be displayed. Once 10 are being displayed, any additional captured plots will cause the oldest plot to be removed, and the newest plot added to the persistence display. |
| 20 trig | The 20 most recent persistence plots will be displayed. Once 20 are being displayed, any additional captured plots will cause the oldest plot to be removed, and the newest plot added to the persistence display. |
| 50 trig | The 50 most recent persistence plots will be displayed. Once 50 are being displayed, any additional captured plots will cause the oldest plot to be removed, and the newest plot added to the persistence display. |
| infinite | The 50 most recent persistence plots will be displayed. Once 50 are being displayed, any additional captured plots will cause the oldest plot to be removed, and the newest plot added to the persistence display. |

All captured plots are recorded. The most recent 50 are rendered as individual plots. Plots 51 and older are recorded as a bitmap, which goes behind the graph grid. In this way you can differentiate between the current plot, the last 50 plots, and older plots.

11.1 Example Plots

In these example plots we have used two signal sources of very nearly the same 1 kHz frequency. If we trigger off one, the other plot will move slowly across the screen to the right. This is useful for showing the persistence effects. We used the Probe Comp and Signal Generator output to make these plots.

A plot with Persistence Off.

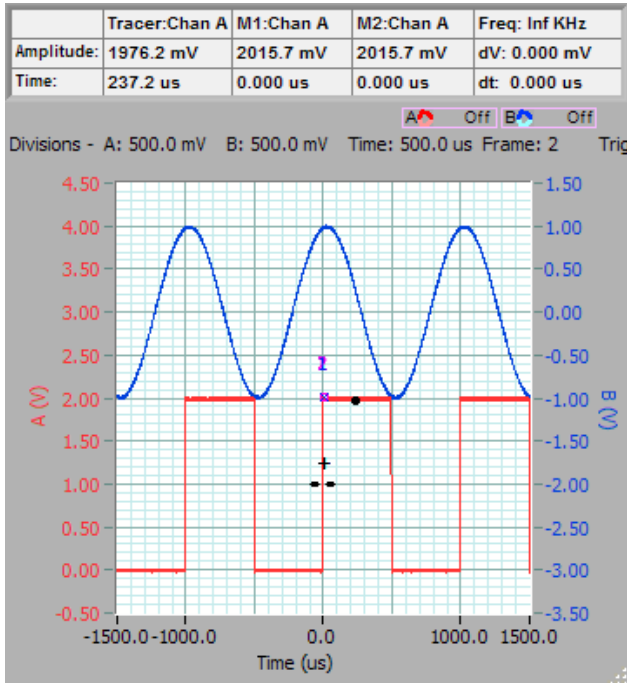

A reference has been added on Channel B.

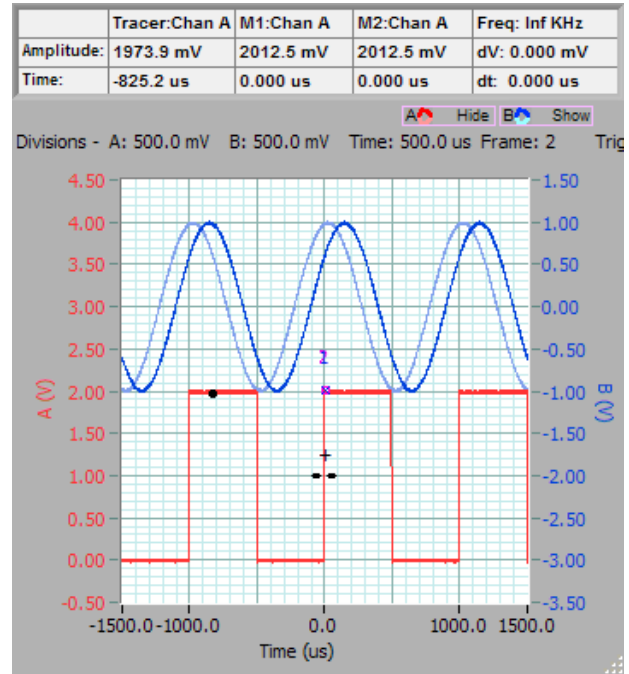

Notice that the reference appears as a lighter colour line. If you change the time or amplitude axis, the plot will change to conform to the new graph settings. As you make further captures, you can check the relationship between the reference and the latest capture.

After using *Addr*, the control automatically changes to *Show*.

If you use *Clear*, the reference will be cleared, and you will see only the latest capture. After using *Clear*, the control reverts automatically to the last state, *Show*, in this example.

11.2 Persistence Plots

Here we show the differences between the 4 types of persistence plot:

10 trig

Channel B moves the 10 most recent plots to persistence.
The oldest plot is lost as the newest plot is added.

20 trig

Channel B moves the 20 most recent plots to persistence.
The oldest plot is lost as the newest plot is added.

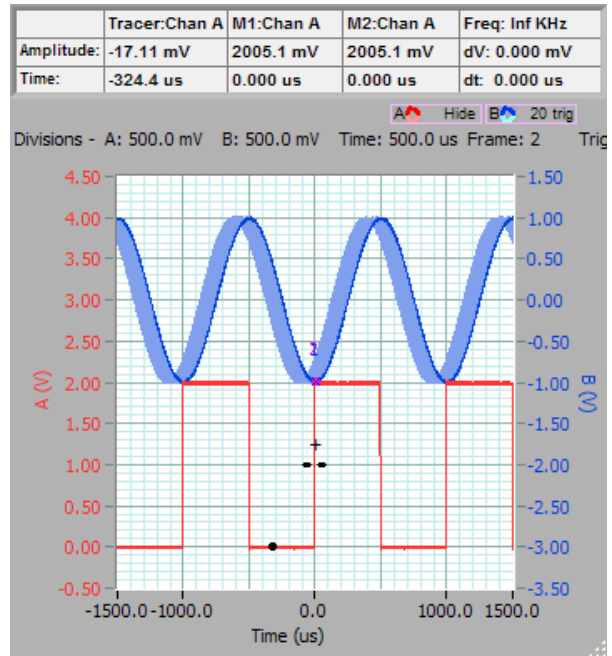
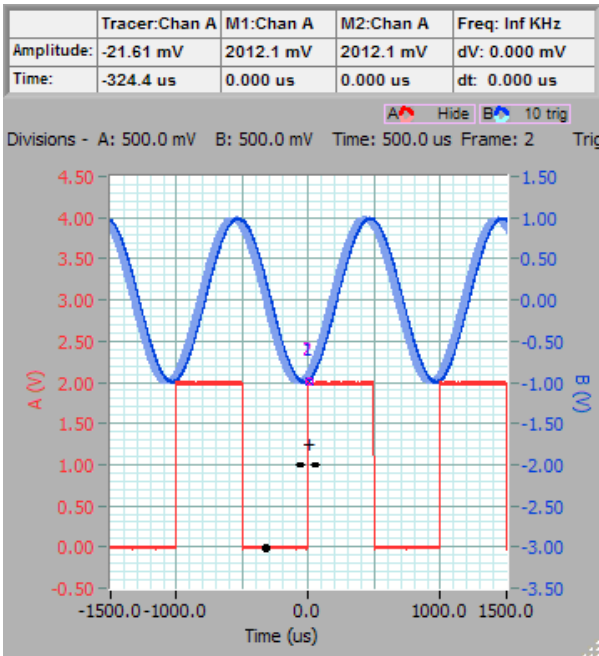

50 trig

Channel B moves the 50 most recent plots to persistence.
The oldest plot is lost as the newest plot is added.

Infinite

Channel B moves all plots to persistence. Older plots are added to a background bitmap.

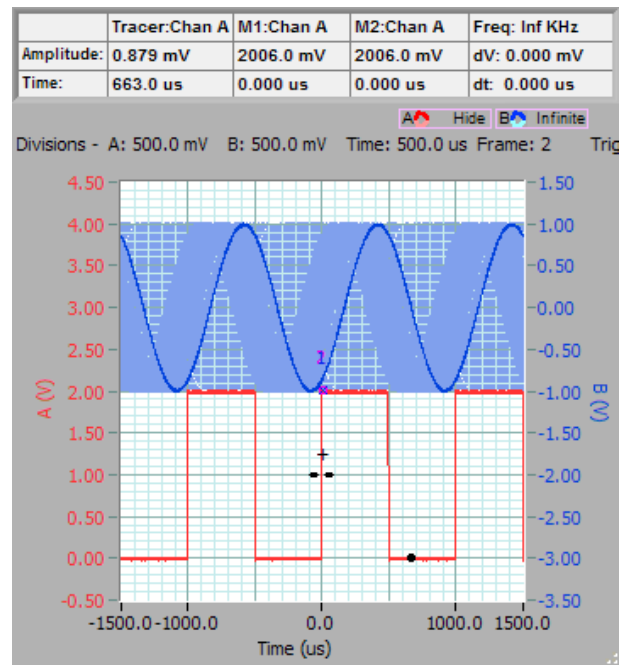
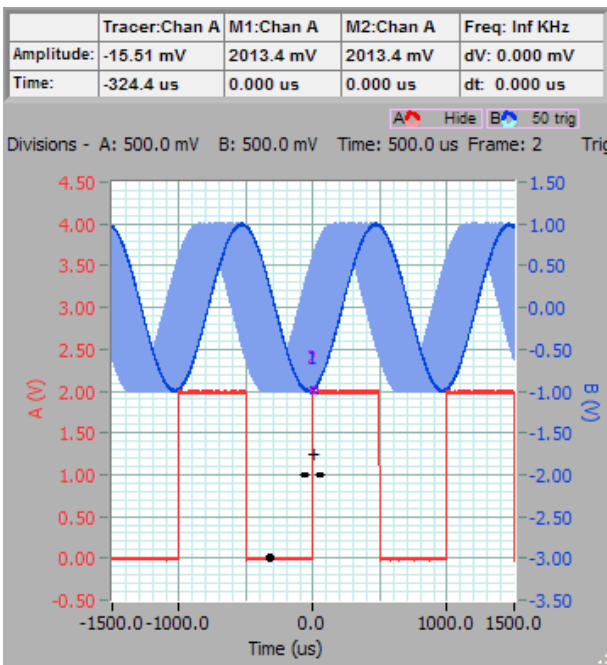

11.3 Eye-diagram Plots

The eye-diagram is a useful way of verifying that a logic signal has sufficient logic level margin to operate reliably. It is also useful to checking the performance of FM discriminators, data slicers, and threshold detectors.

Example logic level eye-diagram:

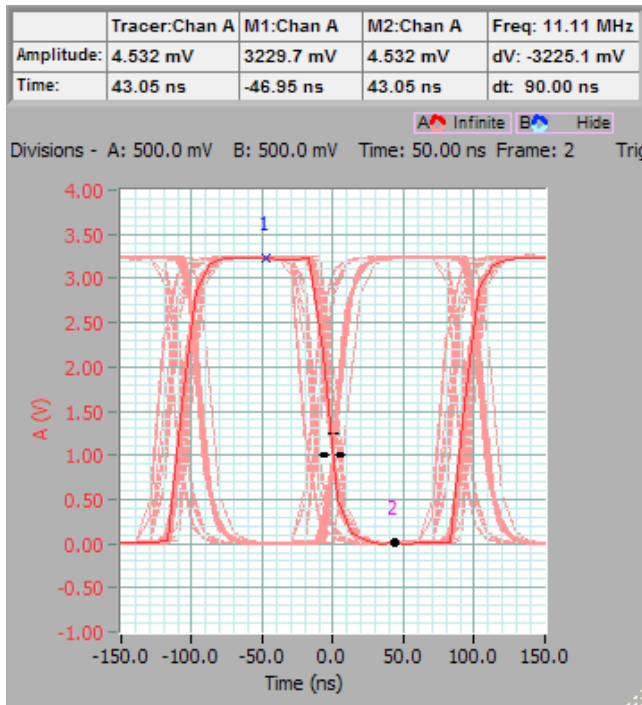

The graph shows a history of the logic level switching. We can see clear areas in each set of logic transitions (the eye), which indicates that this system will be reliable. Because the threshold level was set to 1V, and the duty cycle of the signal was not 50%, there is some variation in position between low going signals and high going signals: - this is a useful tool to check out duty cycle as well.

Note that if you change the amplitude axis, the bitmap will be left as it was, providing a way to compare the history with another channel. If you change the time axis, we clear the bitmap, but not the most recent 50 plots, which will scale properly.

11.4 Performance

The persistence system uses considerable processor resources, especially when using infinite persistence. You may see an increase in CPU usage. The rate at which acquisitions are made will be automatically throttled to limit the maximum CPU usage when persistence is on, especially when several graphs are using it.

11.5 Conclusion

Future Improvements

You can be sure that in the future, Cleverscope will add more functions to the persistence system. Some of the functions we'll be thinking about are saving and restoring references or history, moving the reference signal independent of the graph axis, and allowing Maths channels C and D to be displayed as well. Please make any suggestions you think will improve Cleverscope.

Stored References

While we are planning for the capability to store reference signals, you are able to do so now by saving the required reference signal in a setup file.

Click File then Save As. When opened, select Addref before triggering and the saved signal will be shown as a reference once triggering starts.

12 Streaming

The Cleverscope Streaming system is used to capture, manipulate and analyse signals over a much longer time frame - from seconds to weeks.

The Streaming system saves a continuous record to Hard Disk, at a sample rate of between 200 Samples/sec and 3.2 M Samples/sec. The streaming system can handle very large signal streams - up to about 300 G Samples. You can zoom, pan, use the Tracking, Spectrum and Maths Displays on portions of the stream, and use the Protocol Analyser to decode serial data.

12.1 Capturing a Stream

The Cleverscope application defaults mean that you can simply click **Stream** on the control panel, and streaming will start. Once streaming starts you can adjust the time/division, pause and restart, turn on other displays, and zoom on a portion as capture continues.

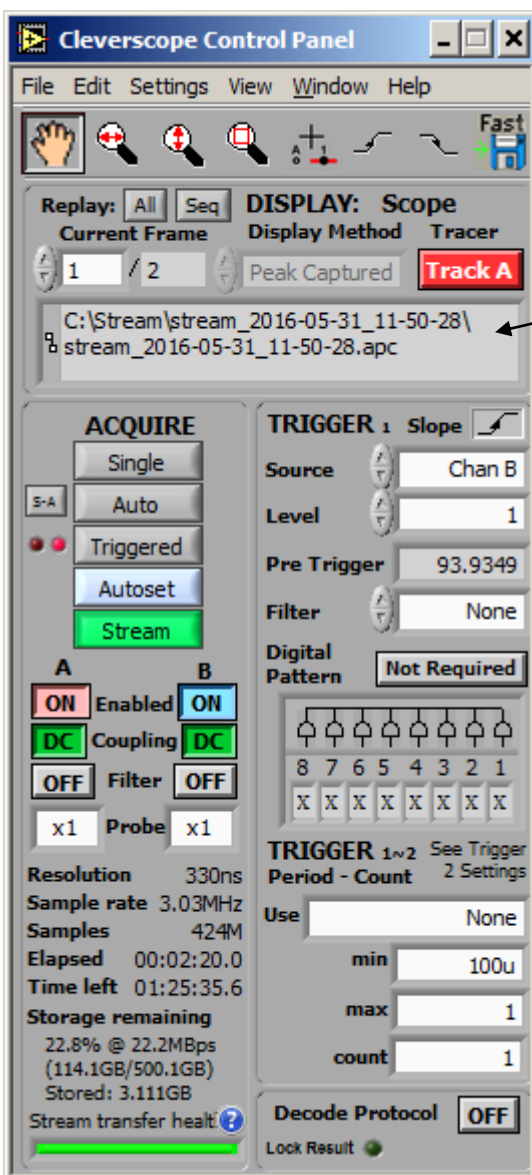

Once Streaming starts, the Stream button is illuminated green, and status information is displayed on the Control Panel.

This is the location of the stream control file. All streams are saved in their own folder. To delete a stream from Hard Disk, delete the folder. The folder location is specified in File/File Options/Streaming:

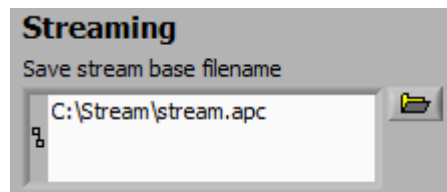

The base name and appended date and time are used to generate the stream folder. The .apc control file, and cleverscope stream files (*.csl) are contained within the folder, which can be moved to a different location if needed.

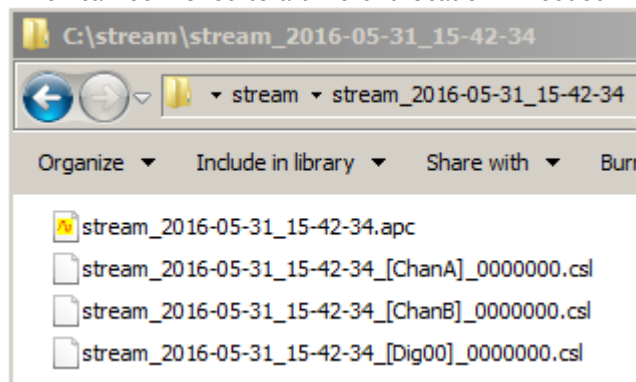

The lower left part of the panel displays the sample resolution (330ns here), the Sample Rate (3.30 MSPS), the number of samples captured (424M), the elapsed time (00:02:20.0) and

the time remaining calculated from the hard disk free space remaining, which is detailed next. Here the Storage remaining is 22.8% of the hard disk (114.1 GB of 500.1 GB), and so far 3.111 GB have been stored. The Stream transfer health display is explained by the  button.

Samples are saved in chunks (of either 25 or 100 MByte) as streaming progresses, one chunk for each channel. Cleverscope does offer a Labview stream reader for sample extraction as a .vi if required. Please ask us.

You can set the Streaming Sample rate using the *Settings/Acquisition Settings/Streaming* value:

The Streaming sample rate will be rounded to the capture sample rate (10ns for the CS328A). The range is 200 - 3.2 MSamples/sec using USB and 200 - 1.6 MSamples/sec using Ethernet.

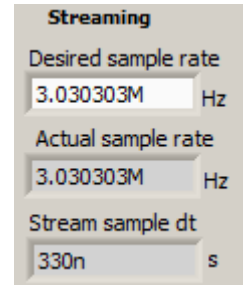

You can use two capture options to decimate the data, depending on the Display Method:

- Sampled, in which case the signal is first filtered by the current filter setup, which can be used to improve SNR and the resolution, and then one sample is taken every sample interval (ie one sample every 330ns or every 33 samples in this example).
- Peak Capture - in this method alternating minimum and maximum values in the sample interval are recorded. Sine waves will be truncated to minimum and maximum values in each sample interval.

During Streaming, the signal streams from the right hand side of the graph. Here is a typical view:

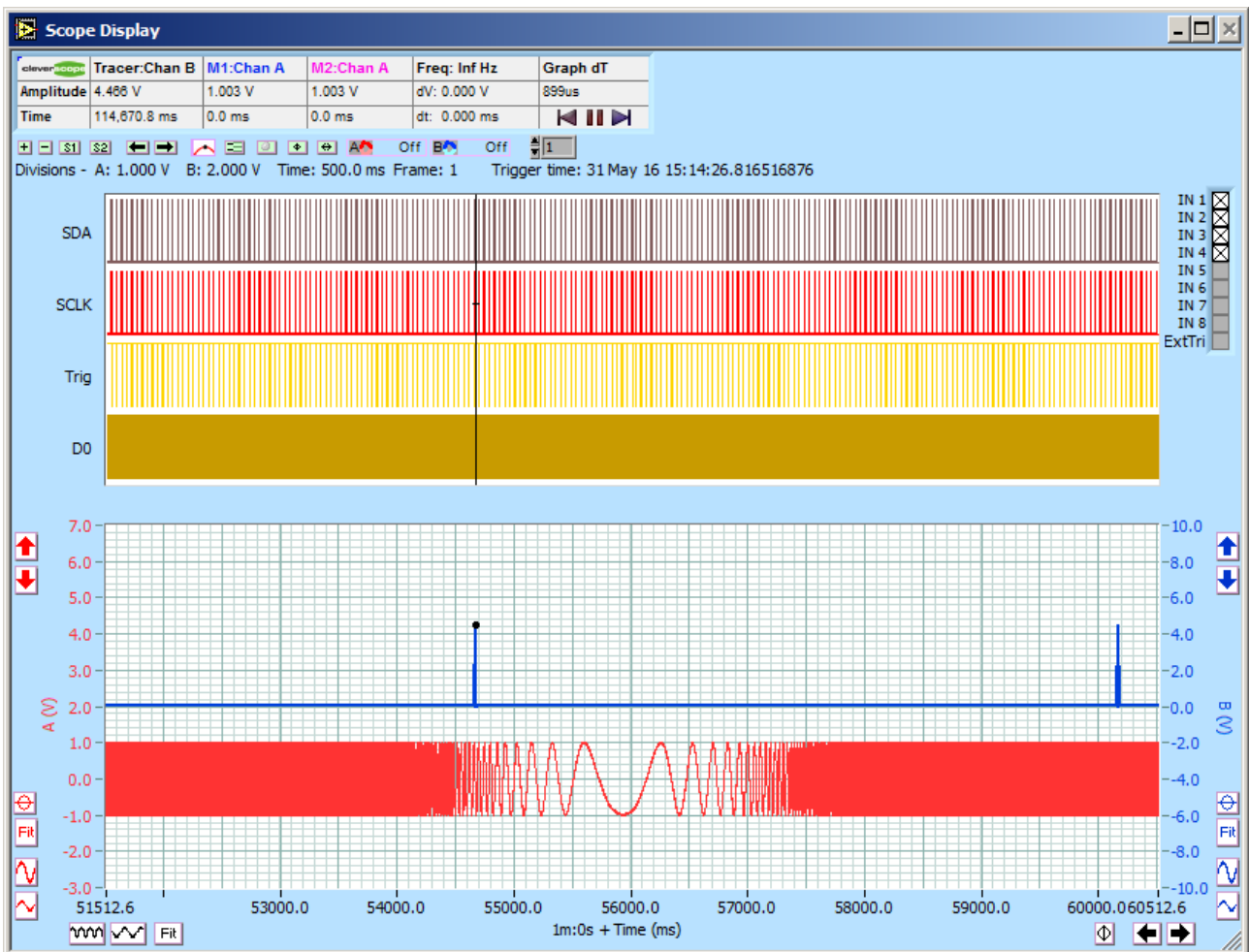

You can adjust the Time per Division by clicking on the time axis expand and contract buttons . Here we display at 500 ms/div.

While operating you can go to the beginning of the stream, pause the display, or go to the end of the stream using these control buttons . If you Pause, you can zoom and pan, open other displays as required. To start again click the button.

To finish streaming click the  button again.

Once you have finished the Stream is automatically saved to disk, and a dialog pops up momentarily to tell you that.

12.2 Reviewing the Stream

To see the whole stream capture click the time axis  button. The entire time period is now brought into view:

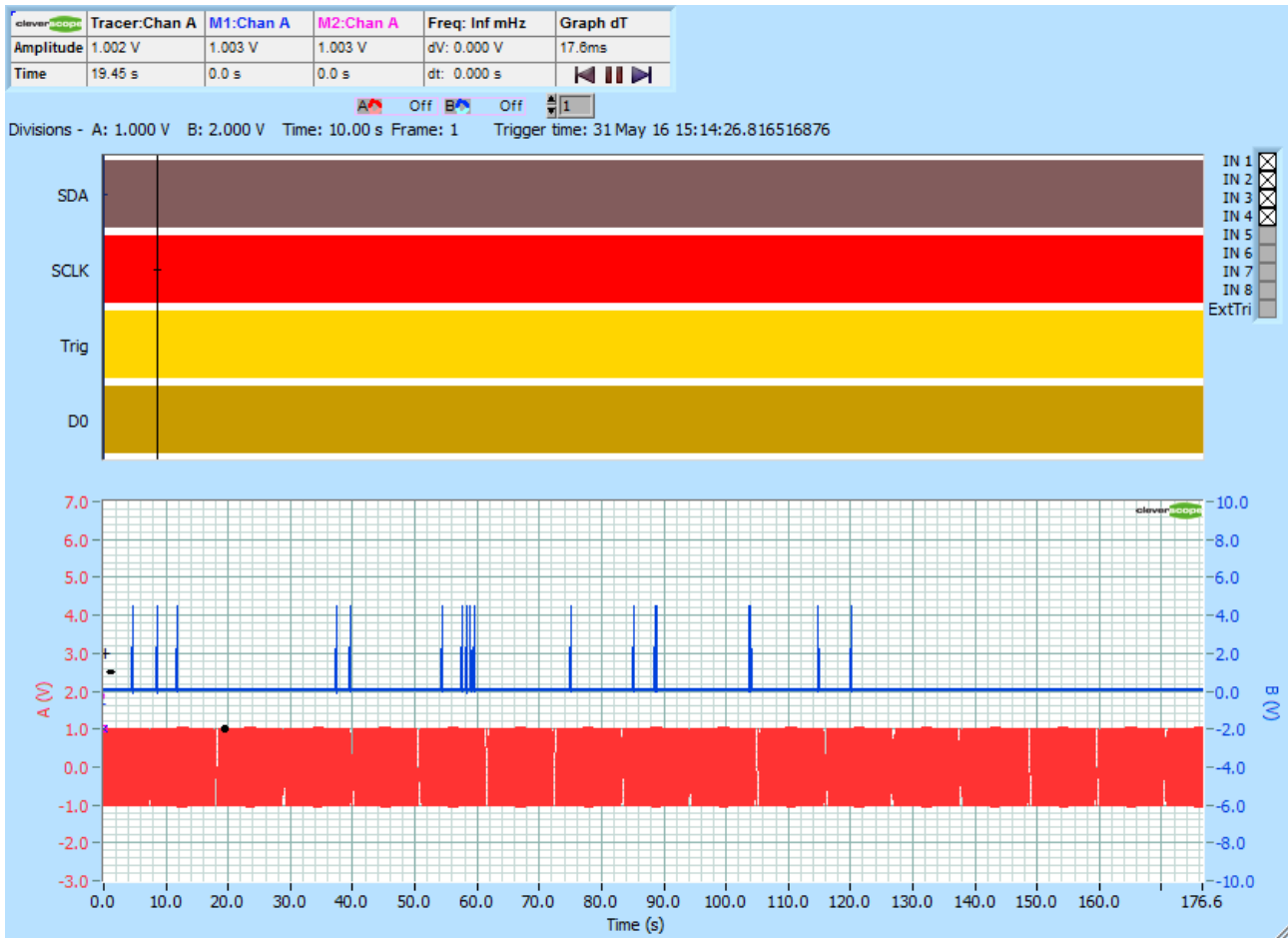

The duration was 176.6 seconds. Duration up to weeks can be captured, especially if the sample rate is set lower.

Now you can zoom as normal. To zoom on the Tracer, position the Tracer, and use Ctrl ← and Ctrl →.

Here we zoom on 39,656.3 ms:

You can see what looks like a pulse, and the low frequency part of the swept signal generator output.

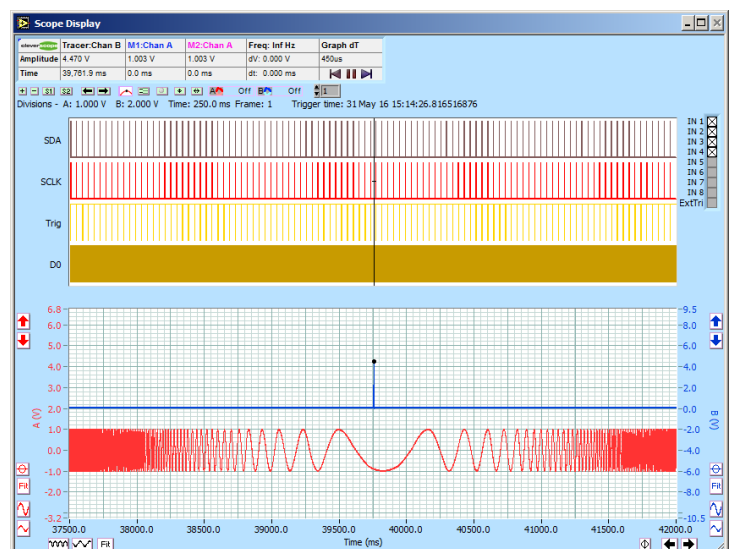

We zoom even closer:

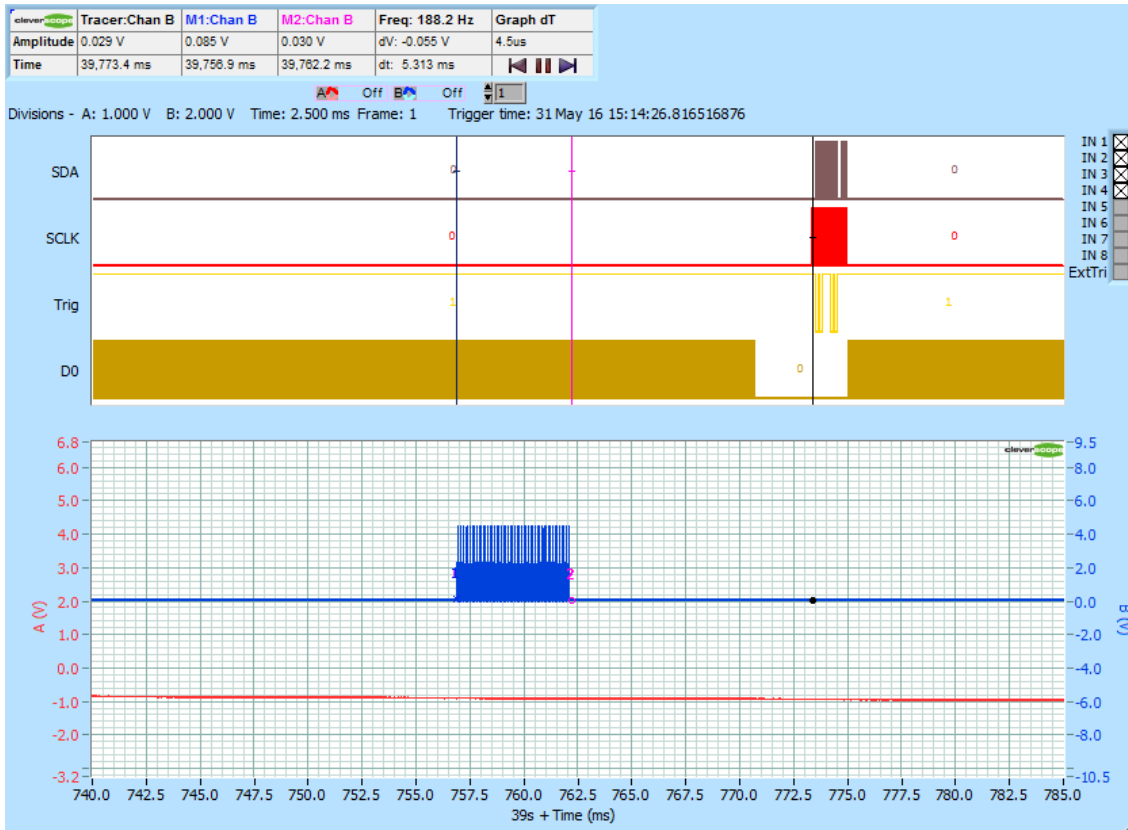

And we see that the pulse is in fact a pulse train, and that the digital graph is showing some kind of serial data (SPI as it happens). The pulse train is 5.313 ms wide (see the two markers).

We zoom further and see that there are in fact 30 pulse in the train. Here is the first one, and it is 2.97us wide:

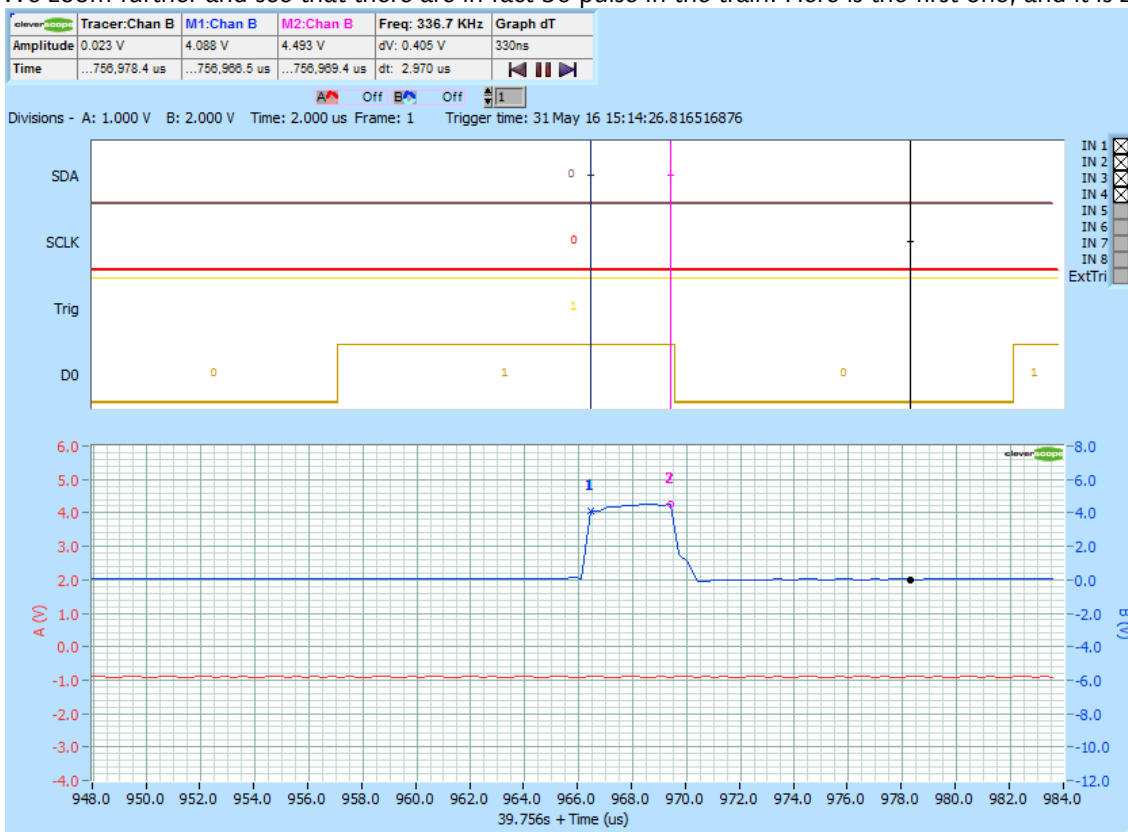

Click Decode Protocol ON **Decode Protocol ON**, and then the protocol is decoded and added to the digital display:

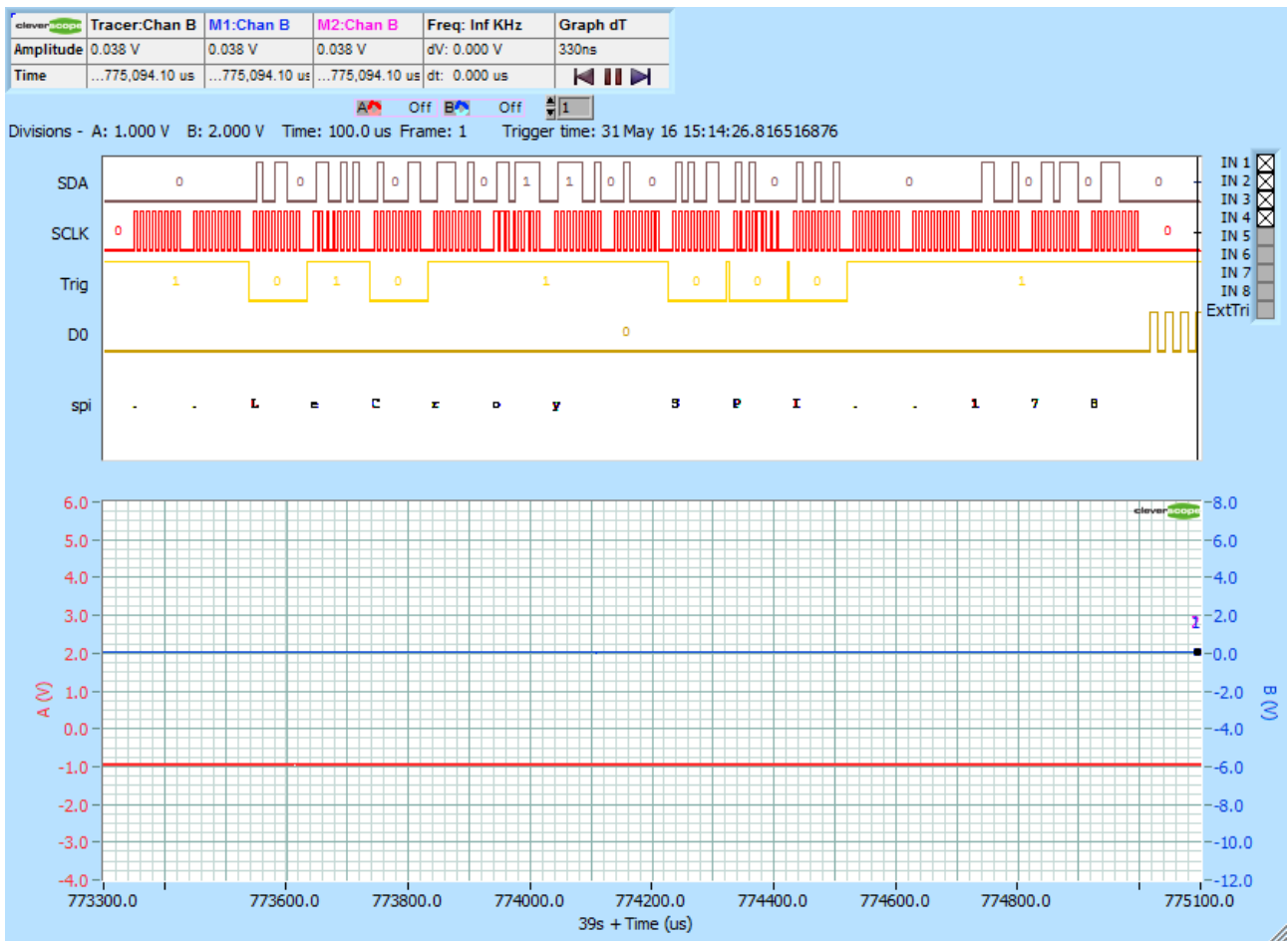

We see the message LeCroy SPI 178. As we had Copy to Notes turned on, if we use View/Notes, we see the decode in the Notes window:

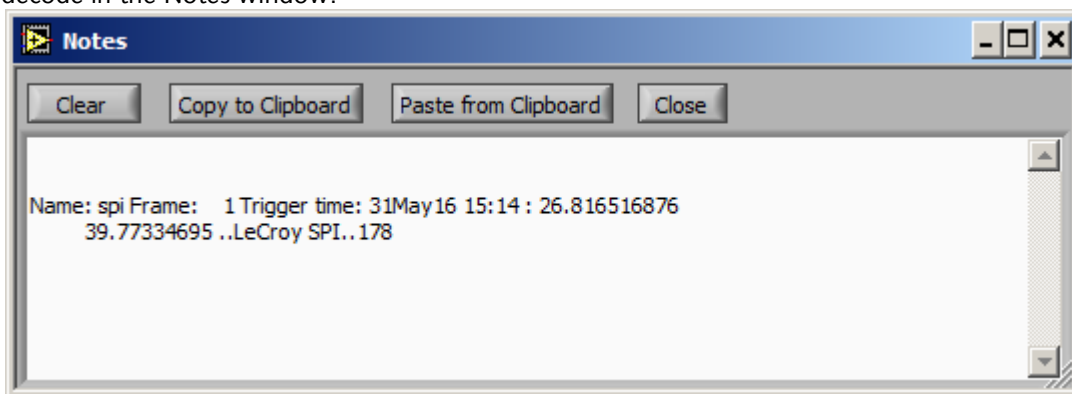

We can copy this pre-formatted message into Excel for easy analysis (tabs are used for column separation).

12.4 Tracking and Maths Display of a Stream

We can open a Tracking Display and using the View/Display are Linked option move the Tracer to see an expanded view as normal.

We can open a Maths Display, and do maths on the section of graph currently visible in the Scope Display.

12.5 Spectrum Display of a Stream

We can also open the Spectrum Display (View/Spectrum Display), and do spectral analysis on the section of the graph identified by the purple bar :

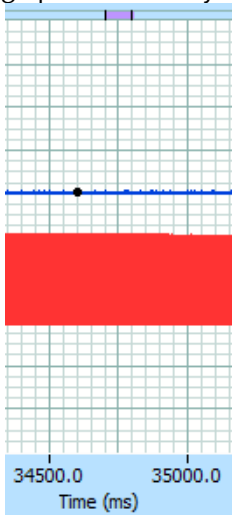

In this section of signal we see the signal generator has transitioned from 63 kHz to 79.5 kHz:

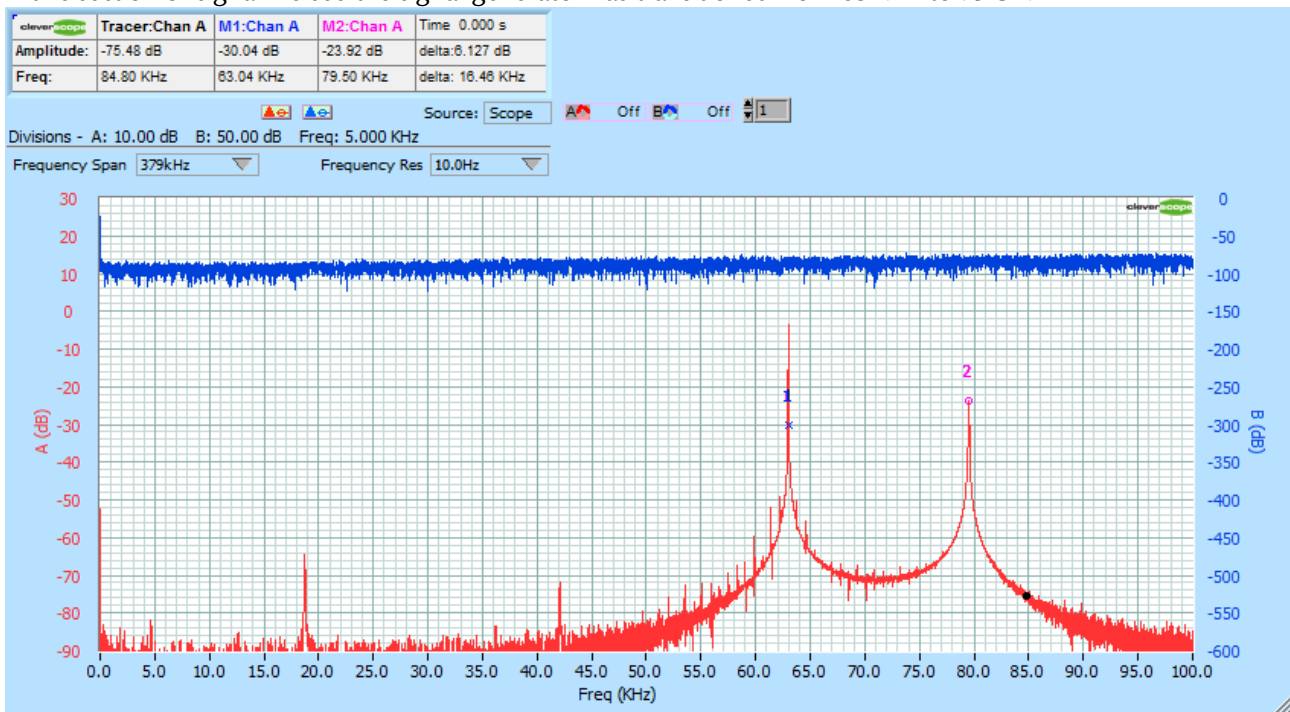

You can set Frequency Spand and Frequency Resolution using the controls:



If you set the Spectrum source to Tracker, and have the Tracking graph open, and following the Scope Display tracker, you can display the spectrum at any arbitrary place just by position the Tracer there. The same goes for Maths.

12.6 Open a Stream File

To open a previously saved Stream, either use the File/Most recently used file list, or File/Open, and navigate to the Stream folder, and then open the .apc file in there.

13 Signal Information [View Menu]

13.1 Signal Information Display

The results of mathematical functions applied to Channel A and B signal data are displayed in the **Signal Information** display table.

Signal information values are calculated from the signal on the selected source display specified by **Information Source**.

Note: You can use the **Tracking Display** to derive information over a smaller time period, and by linking the **Tracking Display** to the **Scope Display**, and selecting the **Scope Display**, and moving the mouse over the display, trace variations in value such as Frequency, DC or RMS. Data is only updated if the source display is open.

Signal Information

| Function | Chan A | Chan B |
|-----------------------|---------|----------|
| DC | 13.7 mV | -25.8 mV |
| RMS | 1.01 V | 29.4 mV |
| Max | 1.19 V | 23.3 mV |
| Min | -1.27 V | -68.4 mV |
| Pk-Pk | 2.46 V | 91.6 mV |
| Std Dev | 1.01 V | 14.6 mV |
| Period | 9.91 us | 460 ns |
| Fundamental Frequency | 101 kHz | 44.8 MHz |
| Fundamental Peak amp | 1.28 V | 1.49 mV |
| Pulse Length | 5.21 us | 19.8 ns |
| Duty Cycle | 52.6 % | 4.31 % |

Time Info: Waveform (dropdown), Information Source: Scope (dropdown)

Do Average: Send DDE:

Click on the **View** menu and click on the **Signal Information**.

Function

The function column lists set of mathematical functions the row content for the results of the mathematical functions.

Chan A

Results for the signal incoming on Channel A.

Chan B

Results for the signal incoming on Channel B.

Show logging

Click **Show Logging** button to expand the Signal Information display to show the Log File setup panel.

Hide Logging Time Info

The **Show Logging** toggles to **Hide Logging** when the Logging panel is displayed.

Click on the button to select between *Waveform* or *Pulse* information – this also affects the parameters that will be logged.

Do Average

Click **Do Average** box to toggle Averaging on or off to average all results.

Information Source

Click the button to select the source to be used for calculating function values
Sources are: Scope, Tracker, Spectrum, Maths.
The selected source will be shown on the button label.

Send DDE

Click **Send DDE** to toggle whether data will be transmitted via DDE links.
Check box is green when data will be sent.

13.2 Signal Information – Show Logging Button (Scope source)

Clicking the **Show Logging** button on the Signal Information Display opens the Logging Display portion of the display. Logging provides a log file record of the signal information for the signal on the selected Information Source display. Log file data can be saved as either a text file or in an Excel worksheet and recalled for later analysis.

Note The log file is overwritten when you click **Start Logging**. Values are only saved after an acquisition has been made, independent of the update interval. An update interval value of 0 seconds will save on every trigger.

Logging Panel – Scope Source

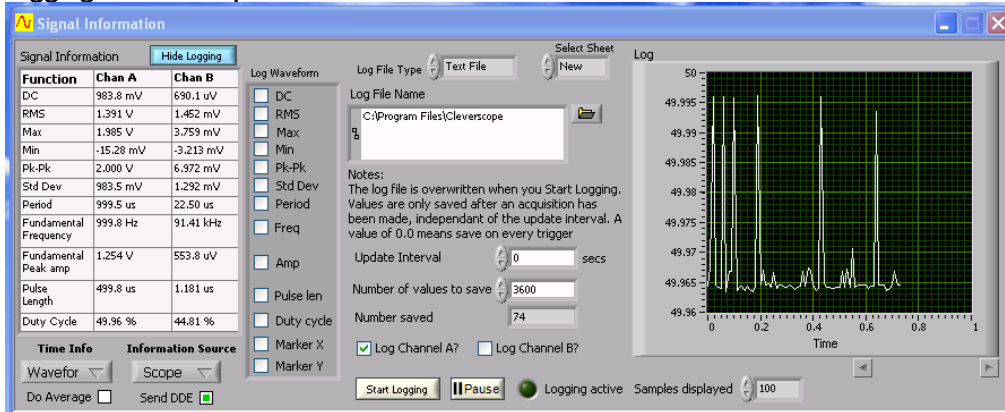

- Log Waveform** Click inside the checkbox to log the results of the function.
- Log File Type** Click on arrows or in field to select **Text** or **Excel** file type.
- Select Sheet** Click on arrows or in field to select **New** or **First** Excel worksheet.
- Log File Name** Click into the **Log File Name** box and type the required file name or click the file open icon to navigate to a folder, open an existing file to overwrite it, or type in a new file name.
- Update Interval** Click on arrows or in field to select interval in seconds. Maximum value is 60480 seconds.
- Number of values to save** Click on arrows or in field to select Maximum value is 67108864.
- Number saved** Displays the number of samples captured at the point the log is stopped or reaches the **Number of Values to Save** setting.
- Log Channel A?** Click check box to log Channel A.
- Log Channel B?** Click check box to log Channel B.
- Start logging** Click button to start logging.
- Stop logging** The **Show Logging** button toggles to green and shows **Stop Logging** once logging starts.
- Pause**
- Logging Active** Indicator glows green when logging in progress.
- Samples displayed** Click on arrows or in field to select the number of samples to be shown on the log screen.

13.3 Signal Information – Waveform Functions (Scope Source)

- DC** This value is calculated by taking the mean amplitude value of the signal data (either full frame or between tracking markers). It represents the DC offset of the signal data for which it was calculated.
- RMS** **Root Mean Square** –The value is calculated by squaring the value of each sample, taking the mean value of these squares; and then taking the square root of this mean value. As for all functions the calculation is either done for the entire frame or between the tracer markers.

| | |
|------------------------------|---|
| Max | Maximum is simply the maximum value of all the samples within the range specified. |
| Min | Minimum is the minimum value of all the samples within the range specified. |
| Pk-Pk | Peak to Peak is calculated by taking the difference between the minimum value and the maximum value within the sample range specified. |
| Period The | Value is calculated by finding the mid-level crossings, and estimating the time between crossings. A hysteresis approach is taken to finding the mid-level crossing point to avoid the effects of overshoot and ringing. |
| Fundamental Frequency | For the highest amplitude component chosen is displayed from a Fourier transform of the signal. |
| Fundamental Peak amp | For the highest amplitude component chosen is displayed from a Fourier transform of the signal. |
| Pulse Length | For the highest amplitude component chosen is displayed from a Fourier transform of the signal. |
| Duty Cycle | Calculated by taking the time at which three consecutive mid-level crossings occur. The Duty Cycle is percentage ratio of the time from the first rising mid-level crossing to the next falling mid-level crossing divided by the time from the first rising mid-level crossing to the next rising mid-level crossing. |
| | Note Cleverscope assumes that the signal is repetitive. |

13.4 Signal Information – Pulse Functions (Scope source)

| | |
|-------------------------|--|
| 0 -> 1 Time | Transition time between 10% and 90%. |
| 1 -> 0 Time | Transition time between 90% and 10%. |
| V '1'. | 'high' voltage. |
| V '0'. | 'low' voltage. |
| V swing | Difference between V '0' and V '1' . |
| Overshoot | Voltage above V '1' . |
| Slew rate | Maximum rate of change of the signal in units of V/ μ s. |
| Pulse Period. | Calculated by finding the mid-level crossings, and estimating the time between crossings. A hysteresis approach is taken to finding the mid-level crossing point to avoid the effects of overshoot and ringing. |
| Pulse Frequency. | For the highest amplitude component chosen is displayed from a Fourier transform of the signal. |
| Pulse Length | Cleverscope assumes that the signal is repetitive. The pulse length is calculated by finding the mid-level crossings and calculating the time difference between the positive going crossing and the next negative going crossing. |
| Duty Cycle. | Cleverscope assumes that the signal is repetitive. The duty cycle is calculated by taking the time at which three consecutive mid-level crossings occur. The duty cycle is percentage ratio of the time from the first rising mid-level crossing to the next falling mid-level crossing divided by the time from the first rising mid-level crossing to the next rising mid-level crossing |

13.5 Signal Information Display – Spectrum Functions (Spectrum source)

| | |
|-----------------|--|
| DC | Calculated by taking the mean amplitude value of the signal data (either full frame or between tracking markers). It represents the DC offset of the signal data for which it was calculated. |
| RMS | (Root Mean Square) calculated by squaring the value of each sample, taking the mean value of these squares; and then taking the square root of this mean value. As for all functions the calculation is either done for the entire frame or between the tracer markers. |
| Fsignal | Frequency of the signal estimated to be the largest frequency component. |
| Vsignal. | Amplitude of the signal estimated to be the largest frequency component. |
| F1. | Frequency of the fundamental signal. |
| V1 | Amplitude of the fundamental signal. |
| F2. | Frequency of the 2 nd harmonic of the fundamental signal. |
| V2. | Amplitude of the 2 nd harmonic of the fundamental signal. |
| F3 | Frequency of the 3 rd harmonic of the fundamental signal. |
| V3 | Amplitude of the 3 rd harmonic of the fundamental signal. |
| SINAD. | Signal in Noise and Distortion. It is the ratio of signal plus noise plus distortion and noise plus distortion. |
| THD. | Total Harmonic Distortion - the ratio of the sum of the powers of all harmonic components to the power of the fundamental frequency. |
| HD2+3. | Is the ratio RMS sum of the 2 nd and 3 rd harmonic referred to the fundamental amplitude. |

13.6 Signal Information Display – Spectrum FRA Functions (Spectrum source)

This display is applicable only if the FRA system is on, and Impedance is being displayed.

| | |
|-------------------|---|
| Z at F | Displays (and logs) the impedance at a user specified Frequency |
| Phase at F | Displays (and logs) the Phase at a user specified Frequency |
| Z max | The maximum impedance in the frequency range, and the frequency at which it occurs. |
| Z min | The minimum impedance in the frequency range, and the frequency at which it occurs. |
| Phase max | The maximum phase in the frequency range, and the frequency at which it occurs. |
| Phase min | The minimum phase in the frequency range, and the frequency at which it occurs. |
| Zmax at 0° | The maximum impedance at 0° phase, and the frequency at which it occurs. |

Zmin at 0° The minimum impedance at 0° phase, and the frequency at which it occurs.

13.7 Dynamic Data Exchange (DDE)

Cleverscope can send DDE messages to any application that can subscribe to DDE links and can embed live data directly in Excel or Access or Open Office Calc.

Links are updated by default as real format numbers with 8 decimal digits.

Note: The **Signal Information** display must be visible for data to be sent via DDE.

13.7.1 Using DDE

DDE uses three values to specify the source (Remote Reference Formulas) : the **Service** name (which is *Cscope*), the **Topic** name (which is *Info*) and the item name. For Excel a typical Remote Reference Formula might be `"=CscopellInfo!A_Freq"` or for Open Office Calc `=DDE("Cscope";"Info";"A_Freq")`. This example will display the Frequency of Channel A in the spreadsheet cell.

Note Make sure Cleverscope is running before opening the spreadsheet.

On the **Help** menu, click **About DDE Links** for more detail.

You can copy and paste one of the already-defined Remote Reference Formulas directly from the help dialog into your receiving application.

As the signal information can have the **Maths Display** as a source, derived maths values can be linked via the DC or Marker X, Marker Y values.

Start the Cleverscope Application software.

Acquire the signals.

Open the Signal Information display.

Click Send DDE.

Open Excel.

Create a new worksheet.

In the worksheet name each row to identify the data to be out into the next cell in the row.

Go to the **Help** menu in the Cleverscope application software and click on **About DDE Links**.

From the lists of link Remote Reference Formulas select one that relates to the data row in the Excel spreadsheet.

Copy and paste from the Help menu into the cell in Excel.

The cell in Excel should be displaying the signal data from the selected channel.

Note: Item names are preceded by either **A_** or **B_** to define which channel is being used. Marker 1 is **A_** and Marker 2 is **B_**.

Note The following list of data link Remote Reference Formulas are formatted for Microsoft Excel. Other applications may use different formatting rules.

e.g `=DDE("Cscope";"Info";"A_Freq")` for Cpen Office.

Time Information

`=CscopellInfo!A_V_DC`
`=CscopellInfo!A_V_RMS`
`=CscopellInfo!A_V_Max`
`=CscopellInfo!A_V_Min`
`=CscopellInfo!A_Pk_Pk`
`=CscopellInfo!A_Std_Dev`
`=CscopellInfo!A_Period`
`=CscopellInfo!A_Freq`
`=CscopellInfo!A_Amplitude`
`=CscopellInfo!A_Pulse_Len`
`=CscopellInfo!A_Duty_Cycle`
`=CscopellInfo!A_VMarkerT`
`=CscopellInfo!A_VMarkerV`

Spectrum Information

`=CscopellInfo!A_F_DC`
`=CscopellInfo!A_F_RMS`
`=CscopellInfo!A_Fsignal`
`=CscopellInfo!A_Vsignal`
`=CscopellInfo!A_HF1`
`=CscopellInfo!A_HV1`
`=CscopellInfo!A_HF2`
`=CscopellInfo!A_HV2`
`=CscopellInfo!A_HF3`
`=CscopellInfo!A_HV3`
`=CscopellInfo!A_Sinad`
`=CscopellInfo!A_THD`
`=CscopellInfo!A_HV2_HV3`
`=CscopellInfo!A_FMarkerF`

Examples:

| | |
|---------------------------------------|---------------------------------|
| <code>=CscopellInfo!A_V_DC</code> | Display A channel DC volts |
| <code>=CscopellInfo!B_HF1</code> | Display B fundamental frequency |
| <code>=CscopellInfo!A_VMarkerV</code> | Display Marker 1 volts |
| <code>=CscopellInfo!B_FMarkerF</code> | Display Marker 2 frequency |

=CscopeInfo!A_FMarkerV

Watch a demonstration of live export to Excel using DDE links and logging on the videos page of the Cleverscope web site "Cleverscope live export to Excel" www.youtube.com/watch?v=lpS2f3Vv6Xc.

13.8 Using Logging

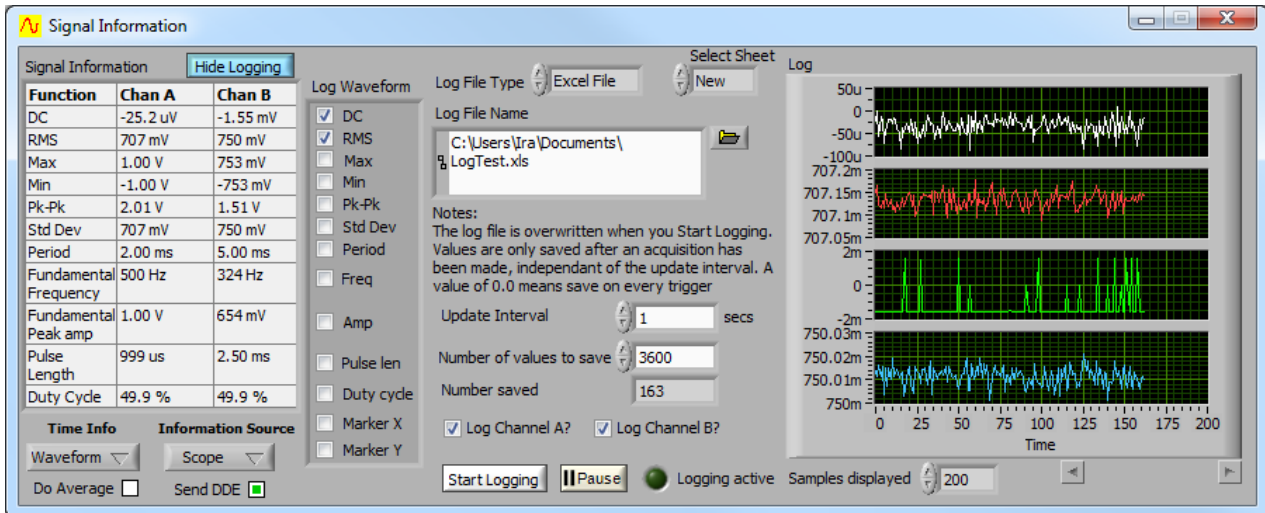

Clicking **Show Logging** expands the window to show all the logging functions so that available signal information can be logged.

Select the items to be logged in **Log Function?** and select to **Log Channel A?** and **Log Channel B?**. Choose a **Log File Type** of *Text File* or *Excel File*. If *Excel File* is selected, also click **Select Sheet** to choose whether the data is logged in a *New* sheet or the *First* sheet. Enter a **Log File Name** including its path or click  to browse to a file. The logging system can open Excel 2000-2010 and log directly into the spreadsheet.

If a **Log File Type** is *Text File*, you are also able to open the file in the standard **Scope Display** and see the first two channels of captured data (use Auto Fit to size the signal to the graph). The saved data includes the 10ns trigger time, which means the log file can be used to find the exact duration between trigger events.

The **Update Interval** includes the value 0. This means save every trigger, which can be used for saving at maximum rate or for sporadic sampling where a trigger only occurs occasionally. An added bonus is being able to see as much of the captured file as you wish while capturing is happening.

Click **Start Logging** to start and stop logging. Click **Pause** to take a break in the logging and click it again to resume logging. The logging will halt when the **Number saved** to the log file reaches the **Number of values to save**.

Similarly to **DDE**, if the **Information Source** is **Maths** then derived values can be logged via the DC, etc. or Marker X, Marker Y values.

The **Log** display graph automatically adapts itself to the number of items selected to be displayed.

Watch a demonstration of live export to Excel using DDE links and logging here www.youtube.com/watch?v=lpS2f3Vv6Xc.

14 XY Display [View Menu]

The **XY Display** displays the XY plot of the channel A and channel B signal data.

14.1 XY Display Controls

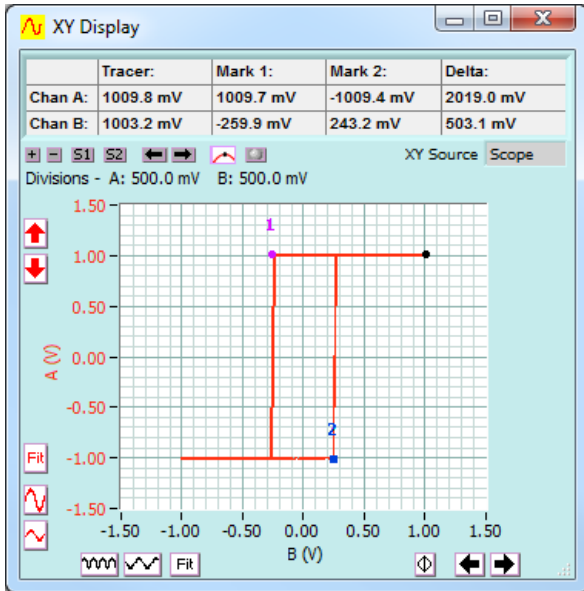

Note: The **XY Display** has an XY Source control in addition to the graph setting buttons that appear on all displays.

XY Display Controls As for other displays.

XY Source Selects the source data from the **Scope**, **Spectrum**, **Tracking**, or **Maths** display.

14.2 Using the X-Y Display

XY Source Select the source data from the **Scope**, **Spectrum**, **Tracking**, or **Maths** display.

14.3 Digital Inputs [View Menu]

Digital Inputs Zone

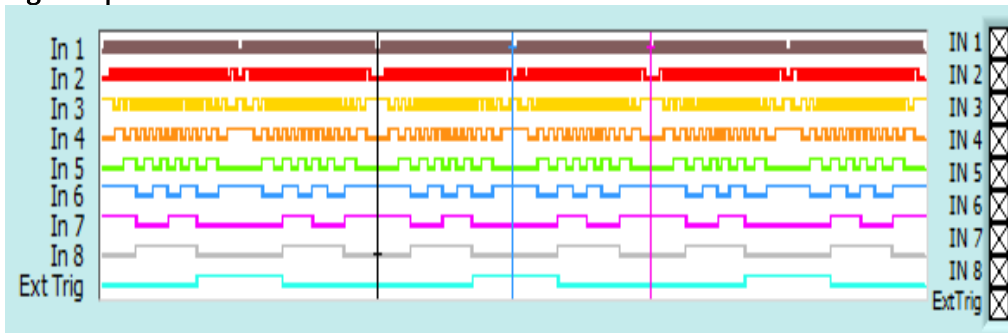

Digital Inputs Displays the pulse trains on each of the 8 digital inputs, In 1 – In 8.

Digital input times (horizontal) axis is locked into the horizontal axis for the **Scope Display** below it.

Horizontal display controls for the Digital Inputs are controlled by the horizontal controls on the **Scope Display | Inputs** display.

Note To conserve display space the **Digital Inputs** can be turned off in the **View** menu.

Note **Digital Inputs** can be made double height on high resolution screens. Click **Settings** then **Digital Names and Colours** and in **Digital Graph Height** select *Large*.

Ext Trig The signal on the External Trigger input is shown on the Ext Trig line as the bottom of the Digital display.

15 Trigger 2 Settings [View Menu]

Trigger 2 Source

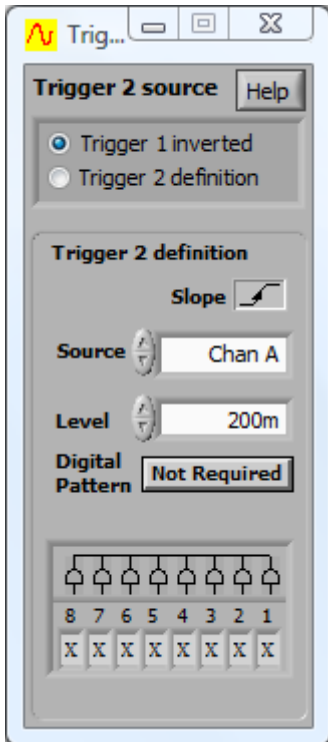

Click on the View menu at the top of the Cleverscope Control Panel and select Trigger 2 Settings (or Ctrl + T).

Trigger 1 Inverted

Trigger 1 inverted sets Trigger 2 to trigger on the inverted trigger of Trigger 1.

Trigger 2 Definition Slope

Defines Trigger 2 as per the Trigger 2 definition area below.

The Slope controls operate the same as the equivalent controls for Trigger 1. The diagram below is displayed when the Help button is clicked:

Selects whether the voltage level will be increasing or decreasing through the trigger point when triggering occurs. The triggering slope is initially determined by the choice of an upward or downward trigger cursor but it can be changed at any time using the slope button without changing the level of the trigger point.

Source

Click on the arrows or in the field to select the source of triggering.

Options are: Channel A, Channel B, External trigger, or Digital inputs.

Link input (Mini-Din connector at the back of the capture unit).

Level

Click on the arrows or type a value in the field to set the triggering Level.

Trigger level is normally set using the trigger cursors in conjunction with the Scope Display.

A separate level is remembered for each source channel.

Hysteresis is used to reduce false triggering due to noise. The normal hysteresis is 2.5% of the amplitude range. Signals must fully transition through the hysteresis band to cause a trigger.

Digital Pattern

Not Required

Click button to toggle whether a digital pattern is required to qualify a trigger.

16 CS700A Signal Generator Module Controls [View Menu]

Cleverscope can be fitted with the CS700A internal direct digitally synthesised signal generator module to generate sine, square, and triangle waves, at a frequency between 0.002 Hz and 10 MHz. You can vary the amplitude over the range 0 → 5V p-p and the offset over the range -4 → + 4V.

The signal generator outputs samples at a 50 MHz rate and uses a 5th order modified Chebychev reconstruction filter.

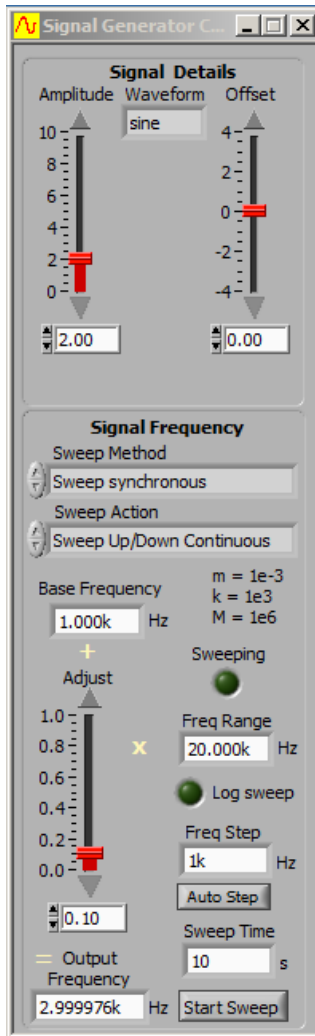

Signal Details Zone

Waveform

Click inside the field to select **sine**, **triangle**, **square**, **DC**, or **OFF**.

Amplitude

Click and drag the slider to adjust the output voltage level. Click on the arrows to adjust the output voltage level on 0.1 volts steps or Click inside the field to type a value.

Offset

Click and drag the slider to adjust the offset voltage level. Click on the arrows to adjust the output voltage level on 0.1 volts steps or Click inside the field to type a value

Signal Frequency Zone

Sweep Method

Click on the arrows or inside the field to select from the dropdown list.

Single Freq (or Volt Offset)

No sweeping occurs.

Sweep asynchronous

Frequency steps occur at fixed time intervals and are asynchronous with the sampling system. Gain/Phase values are not coherent with the signal generator frequency, and records peak values across the entire spectrum range.

Sweep synchronous

Frequency is only adjusted between sample frames. The cycle is Set Frequency - Capture result... Set Frequency - Capture Result. Since this is synchronous with the sampling system no smearing of the spectra will occur. When Gain/Phase is selected, the Spectrum Display automatically interpolates from one frequency point to the next, and gain/phase values are coherent with the signal generator frequency.

Sweep asynchronous 50 Steps

Synchronous capture with 50 points per frequency sweep (decimated to freq step values).

Sweep asynchronous 200 Steps

Synchronous capture with 200 points per frequency sweep (decimated to freq step values).

Sweep in acquisition unit

Automatically sweep the signal generator in the Acquisition unit when doing a multi frame capture, in between captures.

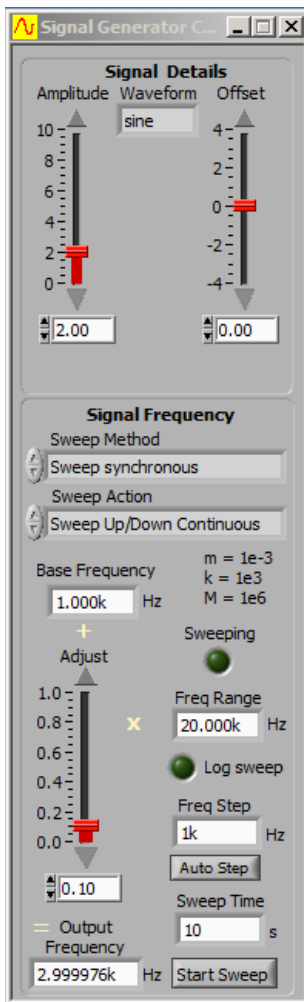
**Sweep Action**

Click the arrows or inside the field to select one of the options

Sweep Up Once

The signal sweeps up the frequency range from the base frequency once and then stops

Sweep Up continuous

The signal sweeps up the frequency range from the base frequency and then starts again from the base frequency.

Sweep Up/Down Once

The signal sweeps up the frequency range from the base frequency and then back down to the base frequency once and then stops.

Sweep Up/Down Continuous

the signal sweeps up the frequency range from the base frequency and then back down to the base frequency and then starts again.

Base Frequency

Click inside field to set the frequency at start of sweep. This is the lowest or minimum frequency.

m= 1e-3 (Milli), K= 1e3 (Kilo), M= 1e6 (Mega)

Adjust

Click and drag the slider to adjust the value of this fractional multiplier applied to the Freq Range.

Sweeping

Glows green when sweeping

Freq range

Sets the range over which the **Adjust** slider operates.

Log Sweep

Click button to capture a log of the sweep.

Freq Step

Click inside field to set the frequency step size (in Hz) for the sweep.

Auto Step

If the Spectrum Display is open, clicking Auto step will set the Freq Step to the size of a Frequency bin. This provides maximum accuracy for Spectrum Display amplitudes

Sweep Time

Click inside field and type a value to set the sweep time in seconds.

Output Frequency

Displays the actual frequency that is output .

Output Frequency = Base Frequency + (Freq Range x Adjust)

Start Sweep

Click to start the sweep.

Stop Sweep

Once sweeping the colour changes to green and the button label changes to Stop Sweep.

Note: Start Sweep button will be inactive for the **Single Freq** option
Click to stop sweep.

16.1 Using the CS700A Signal Generator Module

This example shows the internal signal generator module used to provide a signal to the Cleverscope Channel A input. The incoming signal will be displayed on the Scope Display.

Note: If your Cleverscope was not supplied with a CS700A fitted then you can purchase the CS700A Signal Generator hardware and install it in the Cleverscope Acquisition Unit by following the instructions that came with it.

Pre-requisites

Internal Signal Generator module fitted and calibrated..

Probes compensated. (If not already compensated please follow instructions in the **Cleverscope Basics and Probe Compensation** section.

Cleverscope connected to a PC.

16.2 Connect and Set Up

Connect one end of a **BNC-BNC cable** to **SIG GEN** at the rear of the Cleverscope.

Connect the other end of the cable to **CHAN A** at the front. The Sig Gen signal will be displayed on Channel A of the Scope display.

Alternatively connect a probe to the Channel A input and then replace the probe tip with the BNC adapter and plug the other end of the adapter into the signal generator BNC output on the rear of the unit.

Start the Cleverscope application software.

Click on the **View** menu on the Cleverscope **Control Panel** window.

Click **Sig Gen Controls** (if not already ticked).

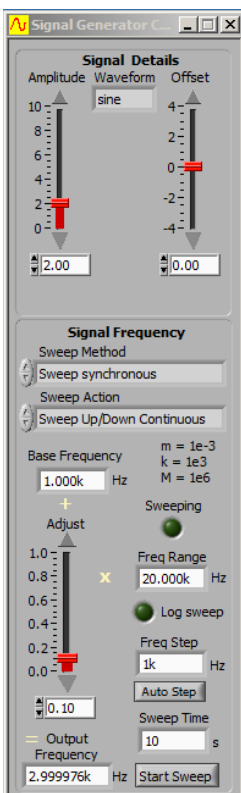

Set Signal Generator Controls

Set **Waveform type** to *sine*.

Set **Amplitude** to 2V.

Set **Offset** to 0V, and

Set **Sweep Method** to *Single Freq.*

Set **Base Frequency** to 1k Hz.

Set **Freq Range** to 20k Hz.

Set **Adjust** to 0.1.

Check **Output Frequency** is 3k Hz (or very close to that value).

16.3 Acquire the Signal Generator Output

Control Panel – Set Acquire

Set Probe



Set Trigger 1 Source

Click inside channel A **Probe** attenuation field to select **x1** option.

Click arrows or inside Source field to select source – **Chan A**.

Set Trigger 1 Level



Click to set the Trigger 1 **Level** to **0**.

Initiate Acquire

Click **Triggered** and you should see a graph similar to that shown

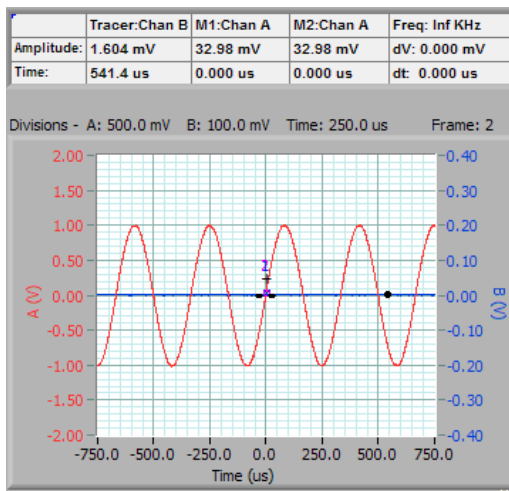

17 Frequency Response Analyser FRA [View Menu]

The Cleverscope Frequency Analyser (FRA) is a tool set you can use to measure Power Supply performance (Gain/Phase response, Input and Output impedance and Power Supply Rejection Ratio) and the impedance and phase of Power input filters, feedback networks, transformers, PCB power planes, and the LCR values of capacitors, resistors and inductors. It can be used for both narrow band swept frequency measurements, and wideband single shot spectral measurements. Values can be displayed in ohms, Farads, Henry's and degrees or radians.

Measuring the performance of switched mode power supplies using traditional methods is difficult because of the switching noise generated by the supply. The FRA uses narrow band frequency domain measurements to synchronously measure the signal generator stimulus and response without being affected by the switching noise. This makes possible the use of low amplitude stimulus signals which do not interfere with the normal working of the power supply - the supply can be measured loaded, and in use.

The FRA is equally useful for measuring the impedance and phase of components such as capacitors, inductors, PCB power planes, transformers, filters and resistors. The gain/phase function can be used to measure the response of networks such as filters, amplifiers, transformers, and mechanical systems.

The FRA is based on a standard CS320A/CS328A oscilloscope, with a CS701 isolated sig generator plugged in.. The CS701 has 300V Class II reinforced isolation, a capacitance of 16 pF to ground when mounted in the CS328A, and negligible series inductance. The CS701 has a frequency range of 0 - 65 MHz, and includes DC offset. For Power Supply work an isolation transformer is not required. The isolation transformer has a more limited frequency range, and introduces higher parasitic capacitance and inductance. The CS701 can be used for Gain/Phase, and low current PSRR measurements. It can be safely used on Mains power supplies up to 230 VAC.

To measure high current PSRR, or find the Input or Output Impedance and phase of live power supplies you will also need the CS1070 power amplifier. It has a 1A capability from -18 to +36V, with a frequency range of 0 - 52 MHz. It can be operated isolated, with care!

You can use the existing CS700A for FRA work, but it is not isolated and so cannot be used for PSU Gain/Phase, and has a more limited frequency range of 0 - 10 MHz.

The FRA is useful for measuring the performance of Power Factor Correction controllers (0.1- 2 Hz), switched mode PWM power controllers (10 - 500kHz), effects of line frequency and harmonics (50 - 10 kHz), PWM Switching Frequency analysis (100k - 2 MHz), EMC (300k - 100 MHz), and LC/Transformer and filter resonances on the power supply voltage rail.

This frequency range is also useful for characterizing anything from power supply bulk capacitors (0.1 - 1000 Hz), to small pF capacitors, nH inductors and ferrite beads at up to 65 MHz.

The +/- 24V DC offset capability of the input to the CS328A means you can measure the response down to DC in power supplies of up to +/-24V. For higher voltage power supplies use AC coupling (with a lower frequency limit of 5Hz (1x probe) or 0.5 Hz (10x probe), or use a CS1030 Differential Probe.

The FRA Control Panel makes it easy to set up everything in one place - you don't need to know how to use the rest of the Cleverscope system. On the panel are controls for you to measure Power Supply parameters such as Gain/Phase, Input and Output Inductance and PSRR, as well as the Capacitance, Inductance, Effective Series Resistance, Dissipation Factor and the Quality Factor of components. Using the FRA Control Panel you can fully evaluate a transformer's transfer response, the primary and secondary inductances, the leakage inductance and inter-winding capacitance, overall frequency behaviour. Using DC offset you can check saturation and DC sensitivity. You don't need to buy an expensive Network Analyser because the Cleverscope FRA does all this for you over a 0-65Mhz frequency range! The Scope Display is useful in being able to see the signal, and check that you are not over-driving a power supply under test.

17.1 Where to next?

Please read the next two sections to get an overview of using the FRA - particularly on power supplies.

The Frequency Response Analyser (FRA) Control Panel is described next. Note that you can click the  button on each panel to get information on that panel.

Finally we have some examples which may be of help. There are further video examples on our website at <http://www.cleverscope.com/fra/>.

17.2 Connections

Connections for each type of test are shown in the connection diagrams.

However for the CS1070, you must also connect the CS1070 link cable between the CS320A/CS328A link port, and the CS1070 Mini-din port.

17.3 Use of the FRA with Power Supplies

One of the most important uses of the FRA is for measuring the gain/phase response of a Power Supply. The response is used to establish stability and bandwidth.

A generic power supply has this form:

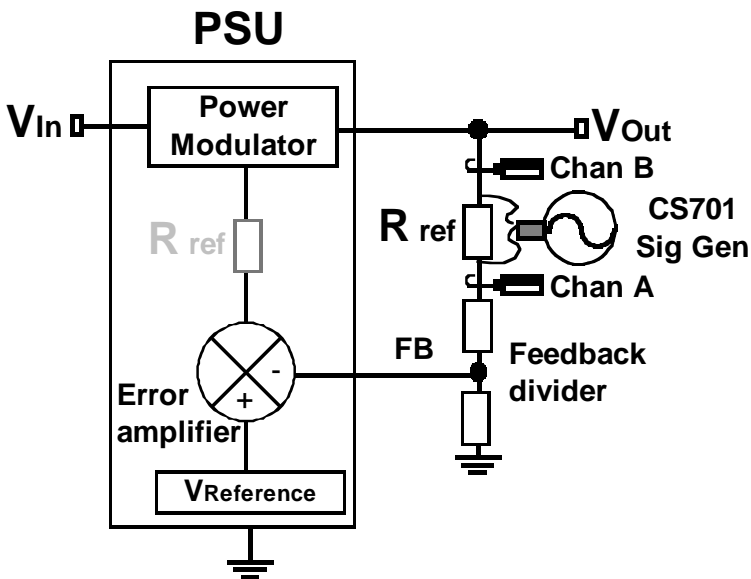

The FRA injects a signal into the feedback path that simulates perturbing V_{out} . This can be done either in the feedback chain, as shown, or after the error amplifier (as shown, greyed).

Key points are:

- An isolated, low capacitance to ground signal source is required. The isolated CS701 is suitable. It is superior to injection transformers as it has performance to DC, and has much lower ground capacitance and series inductance, which act as parasitic elements.
- The injection point is characterised by a low source impedance (and hence a virtual AC earth) looking into a high impedance destination. V_{out} is very

low impedance, while the feedback input is high impedance. This also applies to the error amplifier, and so they are suitable injection points.

- A small value series resistor (20 - 50 Ohm) is used to inject a signal which adds to the feedback signal. The error amplifier sees this added signal and attempts to null it out.
- The Signal Generator injected signal appears as a **stimulus** signal to the input of the feedback chain. This stimulus is measured by Channel A.
- The **response** signal is measured by Channel B, and is the output of the Power Modulator.

The signal frequency is swept over the desired frequency range, while Channels A and B measure the stimulus signals synchronous with this frequency. The measurement bandwidth is quite narrow (between 0.1 Hz and 1KHz maximum) which reduces the in-band switching noise to achieve a useful signal to noise ratio. This means the FRA can measure the response to the signal frequency **independent** of any other corrections the error amplifier is making. Using this method, we can measure the gain/phase response of the Power Supply Unit. To illustrate this here is a Switch mode power supply exhibiting 50 mV of p-p switch noise. Channel A is the stimulus and Channel B the response (and output of the power supply). In this example the Signal Generator was set to 10 mV p-p.

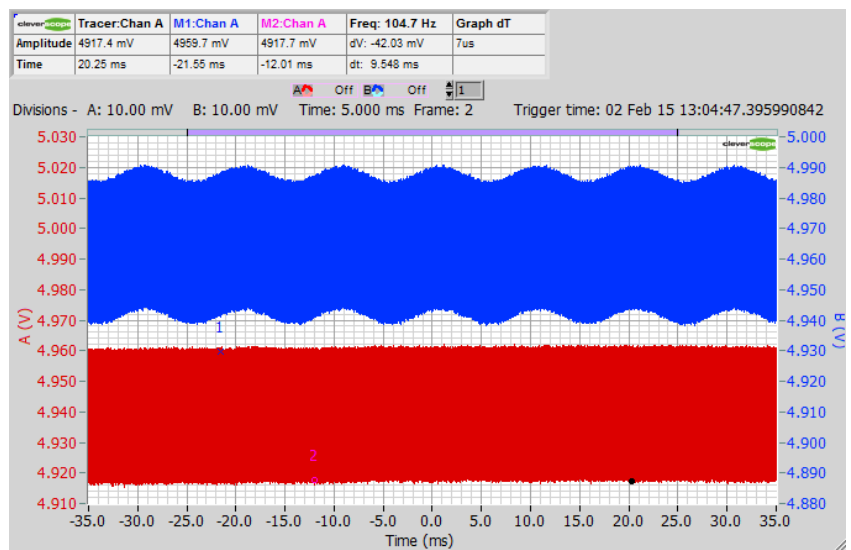

- This results in the following Narrow Band Spectrum:

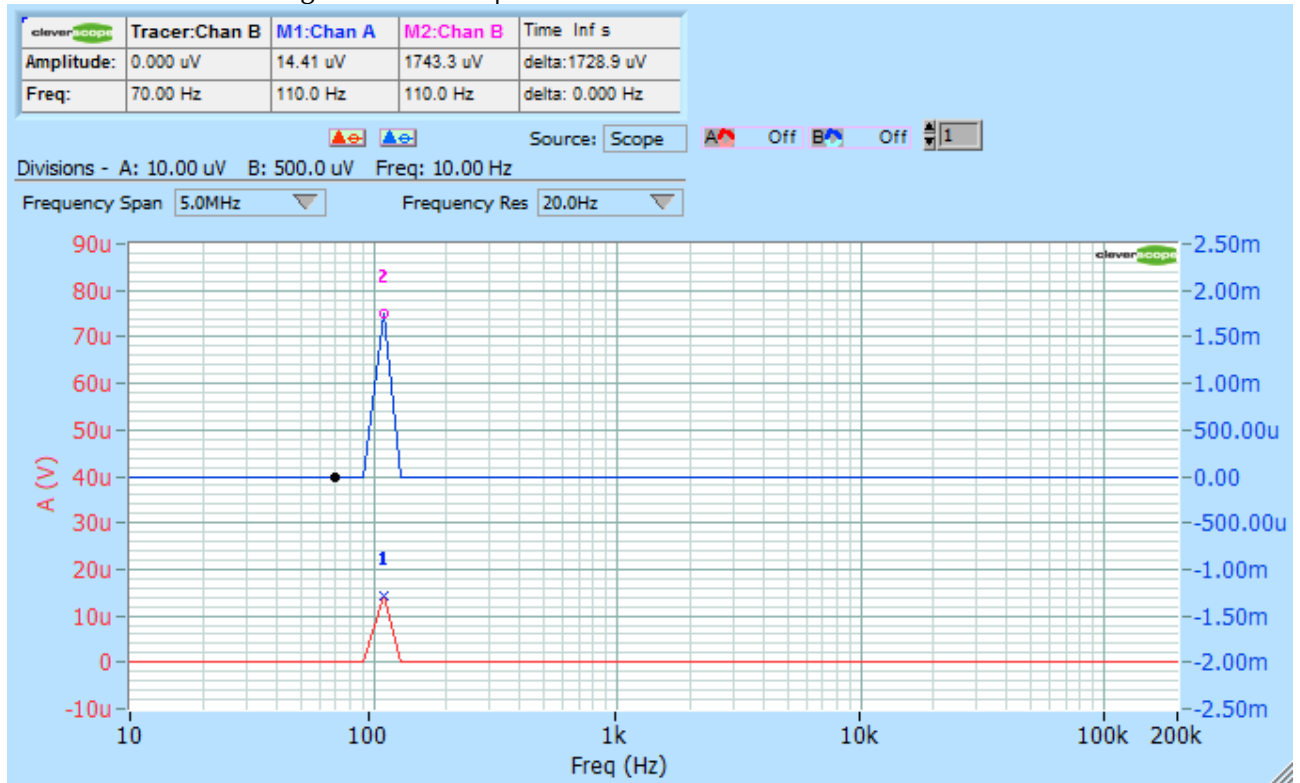

The stimulus (Chan A) has been reduced by the effects of the error amplifier to just 14.4 uV rms. The response, which is the output of the power supply, has an amplitude of 1743 uV rms. The gain of the loop is thus $1743/14.4 = 121$ or 41.7 dB at 110 Hz. Both signals are much smaller in amplitude than the p-p switching noise, and so cannot be seen using a time-domain oscilloscope. Because the response amounts to only 1.7 mV rms, the power supply can be measured in operation without problems. The Information panel displays the Response Amplitude as 1.7 mV rms, and the Signal to Noise Ratio (SNR) as 29.4. The SNR is an important measure of signal quality. A value >3 means that you can trust the results you are seeing. If the SNR is too small, you should decrease bandwidth (20 Hz in this example), or increase the stimulus (10mV p-p in this example).

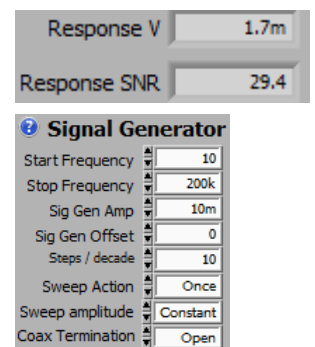

- Channels A and B are DC coupled so we can measure the response from DC up to the maximum signal generator frequency of 65 MHz. They include the ability to DC offset to maintain dynamic range. So you can for example measure a 100mV range centred on 24V DC.
- Channels A and B have high dynamic range. An ADC is used which has sufficiently low differential non-linearity to achieve 14 bits resolution. This is combined with dither to achieve more than 100 dB of dynamic range (10uV in 1V FSD) when taking into account the FFT narrow band process gain.
- The gain of the error amplifier serves to reduce the amplitude of the stimulus signal. An amplifier gain of 60 dB will reduce the stimulus signal 60 dB below the signal generator level. To counter-act this attenuation, the signal generator amplitude can be programmatically varied in the range 1 mV p-p to 6V p-p (and 40V p-p using the CS1070), a dynamic range of >70 dB. When using the 'Auto' or 'Table' method of sweep amplitude control, we can vary the amplitude of the signal generator with frequency to counter the error amplifier gain and maximize signal to noise ratio. This means we have a total dynamic range of about 170 dB available as a combination of signal resolution and signal generator amplitude.
- Error amplifiers have gain that is high at low frequencies, and reduces as the frequency increases. The goal of the power supply designer is to achieve a stable system with minimum ringing in response to a load step. This is best achieved by having a positive phase margin, ideally in the range 50 - 60 degree as the system gain goes through 0 dB (unity gain). As the phase margin reduces to 0 (and the phase lag through the system is 180 degrees), the power supply output becomes more oscillatory. At 0 deg margin, the power supply will oscillate continuously. Analysis of the circuit above shows that we can measure

Response/Stimulus as a complex division to yield gain and phase. Here is an example response:

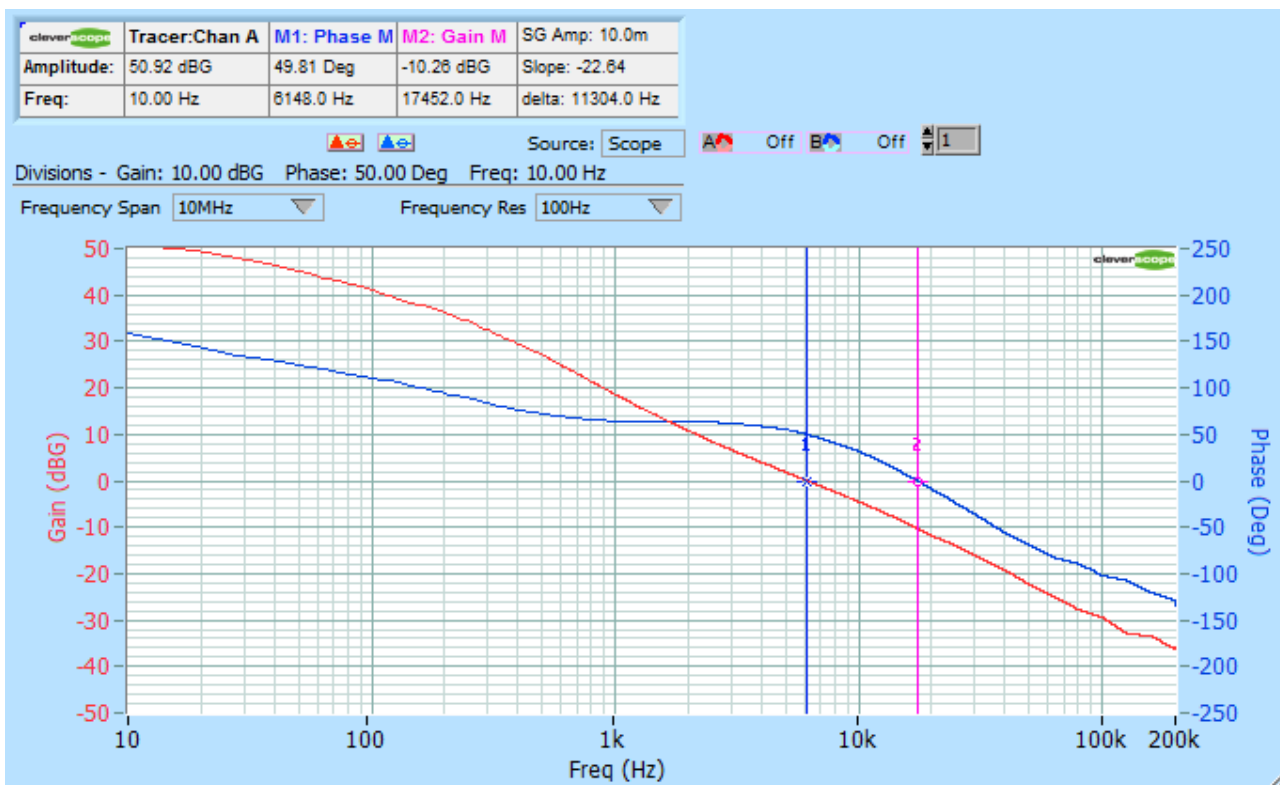

- You can find the Gain and Phase margins by clicking on the **FR 0dB** button. This will automatically position the vertical markers, and place the gain and phase margins, and the frequency at which they occur in the Marker information area. In this example the Phase margin is 49.8 degrees at 6148 Hz where the gain becomes unity. The Gain Margin of -10.2 dB where the phase margin becomes 0 is a measure of how tolerant the design is to variation due to components, voltage, temperature and load.

This power supply has high gain (>50 dB) below about 20 Hz. It is here that we need a large signal generator amplitude (the stimulus) to ensure a measureable response. The power supply output impedance is proportional to gain. At high gains, the effective output impedance is low, and perturbations in load current will not cause large changes in output voltage. As the frequency increases, gain reduces, and effective output impedance increases. At some point, typically for a gain of less than 20 dB, the effective output impedance becomes so high that the power supply does not source the load current without significant output voltage variation. At this frequency we need an alternate current source - such as output capacitors, to supply the load.

The gain/phase, or Bode plot, is useful to measure these factors:

- Stability of the power supply (50 - 60 deg Phase Margin is ideal).
- The susceptibility of the design to component, voltage or temperature change (Gain Margin). 10 dB is minimum, 20 dB is good.
- The frequency at which an alternate current source is required - 900 Hz in this case. This frequency allows us to calculate the size of the output capacitors (from $Z = 1/\omega C$), based on the desired output impedance. We calculate based on the ripple voltage we allow. $V_{ripple} = Z I_{load}$, at the frequency of interest. For some devices such as FPGA's which have a multitude of switching elements it is important to have low impedance over a very wide frequency range (0 - 30 MHz is typical), while for audio amplifiers a much reduced range of 0 - 20 kHz maybe all that is required. Choosing a higher bandwidth power supply unit will reduce the cost and size of the output capacitors needed to maintain a low output impedance.

17.4 Getting Started with the FRA

It can be a bit daunting to know where to start, so here are some suggestions. There are worked examples at the end of this chapter.

If you want to plot the spectral response to a stimulus signal sweeping in frequency then you are in the right place! If you just want to display the spectrum of a signal, then you do not need this panel. For displaying just a spectrum without swept frequency response you should turn off **Use Swept Narrow Band**, and close the FRA Control Panel. The Sig Gen Control Panel is easier to use in this situation.

We suggest you open the Spectrum Display, Scope Display, as well as FRA Control Panel using the View menu. Arrange them so you can see them all at the same time. Choose *View/Displays are docked* on the Cleverscope Control Panel, and then you can move or minimize the whole group around by moving/minimizing the Cleverscope Control Panel.

Close the Sig Gen Control panel, there is no need for it.

There is an individual help button  on most panels that explain that panel in more detail.

If you want to save an FRA capture points only file, see the end of this description.

If you do want a swept response, for most situations you want these LEDs turned on:

- **FRA System ON** - ON - the FRA builds up a picture of the response by sweeping the signal generator over a range of frequencies, and records and plots the response at only that frequency.
- **Auto Ampl Axis Setup** - ON - gives you a first estimate of the amplitude range. If the signals on the Scope Display are being clipped, or are tiny, you can turn this off, and manually adjust the scope display
- **Connect Measure Points** - ON - means all the sample points are joined up.
- **Amplitude/Power in dB** and **Log Frequency Axis** are your presentation choices.

Ok, now you will need to set the frequency range, and Sig Gen Amplitude. If you are using a passive system, a **Sig Gen Amp** of 2V is a good start. If you are working with a Power Supply Unit (PSU) then these are our suggestions:

- **PSU Gain/Phase** - set the **Sig Gen Amp** to 10 mV, and the **Sweep Amplitude** to *Auto*. Set the **Auto Amp Limit** to half the power supply voltage or 6V, whichever is lower.
- **PSU PSRR, Input Impedance or Output Impedance** - set the **Sig Gen Amp** to 1V, and **Sweep Amplitude** to *Constant*.

Now to start a sweep click **Start Sweep**. There is no need to click any other buttons such as the Acquire buttons, or Averaging, or work with the Sig Gen Control panel.

If you have Auto Setup turned on, then at completion of the sweep, the amplitude axis will be auto fitted. Once things are approximately right, you can turn Auto Setup off, and tweak things manually.

Saving FRA files

FRA sequences automatically get converted into very long linear arrays for display. However, if you are after just the data points, you can save them as a text file. After having done an FRA response, make sure the **Spectrum Display** was selected (the Control Panel shows DISPLAY: Spectrum), and then use **File/Save as Text..** and only the swept data points will be saved to the text file. In addition you can use the **File/File Options/Save Options** to choose '**Save using Fast Save Button**' and the **Fast Save button** will appear top right of the Cleverscope Control Panel, and you can save just by clicking the button.

See <http://www.cleverscope.com/videos/> for videos on how to do all this.

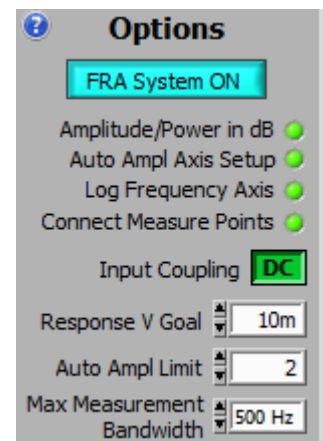

17.5 Frequency Response Analyser Control Window

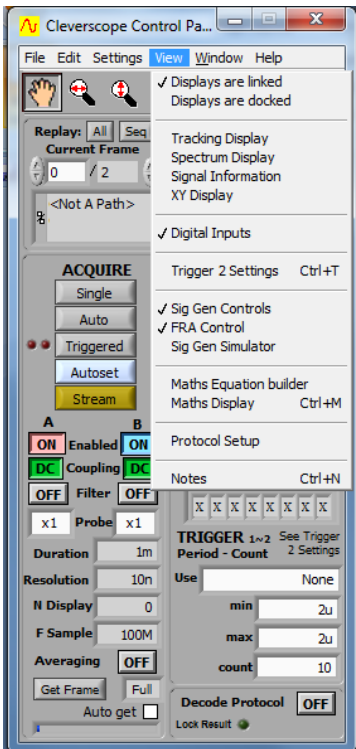

The Cleverscope FRA Control Panel is accessed from the **View** menu.

Click on the View menu at the top of the Cleverscope Control Panel and select the "FRA Control" option.

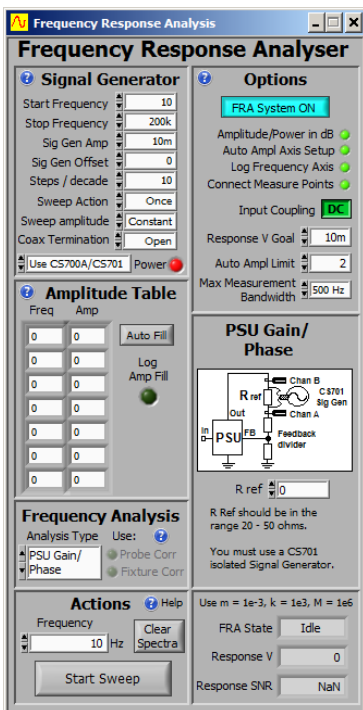

The Cleverscope Frequency Response Analyser Control Panel has 7 panels to make it straightforward to set up the required test conditions.

These are detailed below. The Frequency Analysis panel chooses the type of analysis to be done. The Actions panel is used to start a sweep. The Signal Generator panel defines the signal generator characteristics. The Options panel sets overall capture and display options.

The connections panel shows you how to connect up the FRA, and includes analysis specific values.

17.5.1 Frequency Analysis

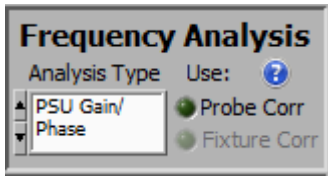

Frequency Analysis

Click on the Analysis type control to choose the analysis type. Each type displays versus frequency. A connection diagram is given in the right hand panel:

To see help click on .

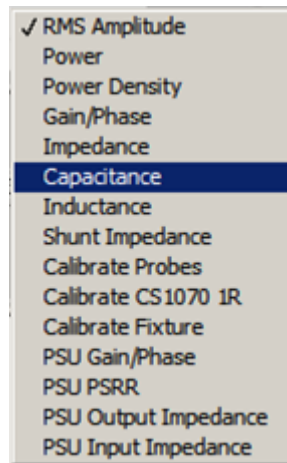

17.5.1.1 Measurements Group

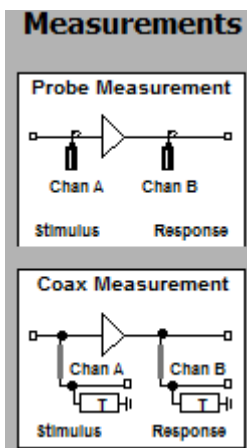

Measurement Group

These types are used for making standard wideband, or swept frequency narrow band measurements (if **Use Swept Narrow Band** is on).

- **RMS amplitude** - RMS amplitude (in dBV or Volts)
- **Power** - signal power (in dBm or Watts)
- **Power density**- signal power density (in dBm/Hz or Watts/Hz)
- **Gain/Phase** - Gain (in dB or G) on Channel A, and Phase (in degrees or rads) on Chan B. Gain/Phase is best done Narrow Band.

To display in dB turn on the **Amplitude/Power in dB** Led in the Options panel, for linear units turn the Led off.

17.5.1.2 Impedance, L, C Group

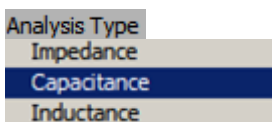

Impedance L/C Group

Uses the Circuit as selected (A, B or C) for the measurement setup. With this group you can measure:

- **Impedance/Phase** - $|Z|$ in ohms or dBOhm on Chan A
- **Capacitance** - C in F on Chan A
- **Inductance** - L in H on Chan A

Chan B displays values based on the L-C Display drop down. These are:

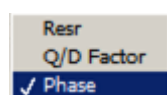

- **Resr** - Effective Series resitsancel in ohms or dBOhm on Chan B
- **Q/D Factor** - Quality or Dissipation Factor on Chan B
- **Phase** - Phase in degrees or radians on Chan B

If you choose Impedance and Phase for the display, you can use the **FR LC** button on the Spectrum display to show the Capacitance or Inductance at the Tracer position (depending on phase).

Using Probes:
(Coax Termination = Open)

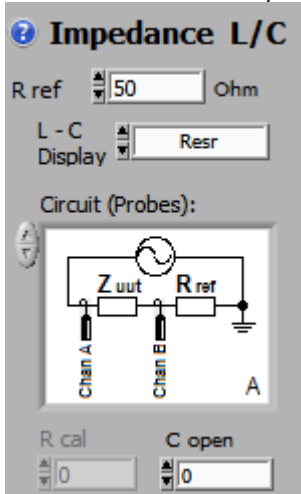

Use this panel to measure impedance, capacitance and inductance vs frequency. Three measurement setups are supported labelled A-C in the **Circuit** control. In addition you use this panel when doing Fixture Calibration. These are the setups:

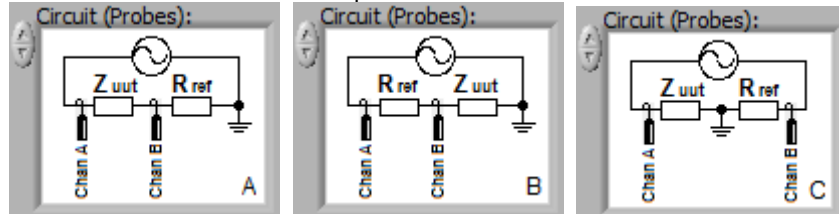

Controls are:

- **R ref** - which sets the reference resistor when using probes. A good starting value is 50 ohm - to match the sig gen impedance. For low esr, or large (>10uF) Capacitors use 10 ohms. Same for low value Inductors (<10 uH).
- **L -C Display**. Choose Resr, Q/D Factor or Phase as appropriate to be plotted to Chan B. Use Fit after plotting to see the whole amplitude range. Position the tracer on the plot you wish to expand, and then use Ctrl Up/Down to zoom in/out on that tracer position. Use Tab to switch between channels.
- When using Coax, **Circuit** lists three coax connection circuits.

Using Coax
(Coax Termination <=> Open)

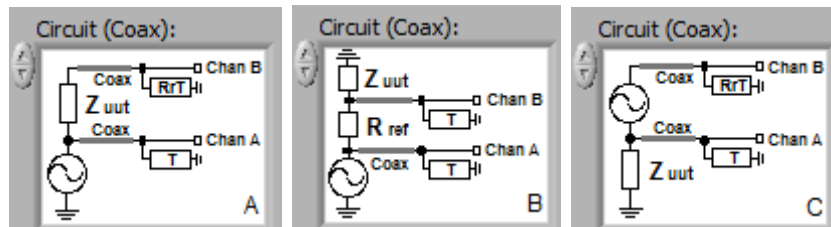
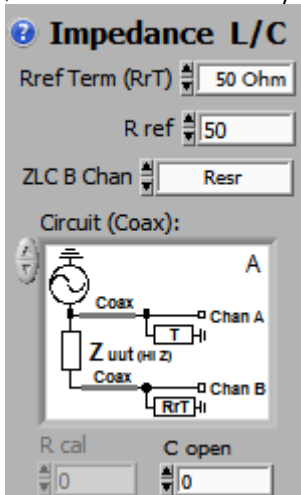

- **Rref Term (RrT)** - sets the measurement termination resistor value for Circuits A and C if you are using coaxial cables. Coax is best when you are working above 10 MHz. Coax should be terminated for maximum accuracy. 50 ohms is a good value.
- **R ref** - which sets the reference resistor for Circuit B. A good starting value is 50 ohm - to match the sig gen impedance. For low esr, or large (>10uF) Capacitors use 10 ohms. Same for low value Inductors (<10 uH).
- **R Cal** is used as a calibration resistor and replaces **Zuut** when calibrating the jig. See the calibration section below.
- **C Open** is used to compensate for the jig open circuit capacitance. Typical values are 0.5 - 1pF.

Circuit and Measurement Jig Discussion

For low frequency applications (< 10 MHz) you can use the scope probes to directly connect to the device under test. For High Frequency (>10 MHz) we recommend using a 50 ohm terminated coaxial cable connected test system. See the 'Impedance Measurement with FRA' video on www.cleverscope.com/videos.

Circuit C results in the greatest accuracy as both the Rref and Zuut voltages are measured independently in the frequency range up to 1 MHz. Above

1MHz the signal generator and coax parasitics can load the components being measured if capacitance or inductance values are small.

Where only small voltages will result across Z_{uut} (eg inductors at low frequencies, capacitors at high frequencies, or low value resistors) use Circuit B as it measures the low voltages accurately (but still not as well as Circuit C at <1 MHz).

Where large voltages will be across Z_{uut} (eg capacitors at low frequencies, inductors at high frequencies or large value resistors) use Circuit A.

For high frequency applications, higher impedance, Circuit A yields the best performance. The 50 ohm termination on the BNC coaxial cable acts as the Reference resistor. Set R Ref to 50 ohms. For low impedance (such as ground and power planes) use Circuit C. For **best results** above 1 MHz when using probes do a Probe and Fixture Correction (see *Calibration* section).

The scope probes set to 1x give the best dynamic range, but because of the approx 70pF/1M ohm loading the impedance under test should equate to less than 1/10 of this - for example capacitances > 700 pF or impedance < 2k at 100 kHz or 200 ohm at 1 MHz. When using smaller capacitors, or higher impedances, use the 10x probe setting, which loads about 17 pF/10 M ohm on the unit under test. This reduces dynamic range by 20 dB. You can compensate to some extent by reducing the Max Bandwidth by a 1/10 (eg to 100 Hz). Make sure you do a Probe Calibration before starting out.

In both cases the Probe ground clip inductance ends up limiting the maximum usable frequency to about 10 MHz. After that you need to use a 50 ohm terminated coaxial cable test jig. When using SMT parts we recommend a 3 port BNC test fixture (see Impedance Measurement with FRA video on www.cleverscope.com/videos) which you can build yourself. Cleverscope also have a fixture available on our website.

A signal generator level of 2-4V works well, dependant on component rating. For electrolytic capacitors apply a voltage bias by setting the Sig Gen offset to a positive value (eg 0.5V), although data sheet values are measured without bias.

If the system is capturing signals, but the spectrum result is 0 for that frequency, the system has determined that the **signal to noise ratio** (SNR) is poor, and the measurement suspect, and therefore not displayed. Improve it by lowering the Bandwidth, or increasing the signal level.

Keep an eye on the Scope Display, and make sure the signal fills at least 10% of the amplitude range at maximum amplitude, but is not larger than the graph range (otherwise clipping and errors will result). You can set Sweep Amplitude to Auto, and higher response goal V, such as 300mV if unsure, but this will be slower. The wide dynamic range will ensure good operation if you are using a constant sweep amplitude. You can use Auto Setup to get a reasonable approximation to the settings you need, and then turn Auto off, and fine tune if necessary.

Bad SNR will manifest as lots of noise in the measurement curve. If you are having problems with noise in the plot, decrease the measurement bandwidth or increase the signal generator amplitude. A good starting point is 1kHz, but if too much noise, reduce BW to 100 Hz. Note that the ratio between Stop Frequency and Bandwidth cannot exceed 1M. If it does, the Bandwidth will be raised, and resolution at low frequencies reduced.

Use CS700A/CS701:

Shunt Impedance

R Ref is the Signal Generator internal impedance. Used to measure low (<20 ohm) impedances. If using coax set R Termination as used.

R ref Ohm

- **Shunt Impedance** - used to measure low impedance (1 mOhm to 20 Ohm) values. Does not require a reference resistor. Use the Circuit as shown - you must use a terminated coaxial cable connection to project a 50 ohm impedance to the board connection. Keep the coax pigtails as short as possible. The CS1070, if available, allows impedance and phase measurement with higher voltages and into powered up circuits with voltages as high as 30V. If using just the CS700A or CS701 a maximum circuit voltage of 3.3V applies. Impedance in Ohms or dBOhms. Good for PCB impedance measurement with powered or unpowered power planes.

For both the CS700A/701 and the CS1070 you must use the 50 ohm output to ensure best matching to the coax at high frequencies. The CS1070 1R output is not suitable due to mismatch.

Use CS1070 50R:

Shunt Impedance

R ref is the Signal Generator series impedance. Used to measure low (<20 ohm) impedances. If using coax set R Termination as used.

R ref Ohm

Use the CS1070 to boost the signal generator output voltage. The CS1070 can output a signal over a voltage range of +30 /-18V. To measure shunt impedance on a powered up Unit Under Test (UUT) make sure the CS1070 has power connected, and is disabled (red led on). The CS1070 power supply should be at least 2 volts higher than the UUT voltage. Connect up the system as below (with power turned off to the UUT).

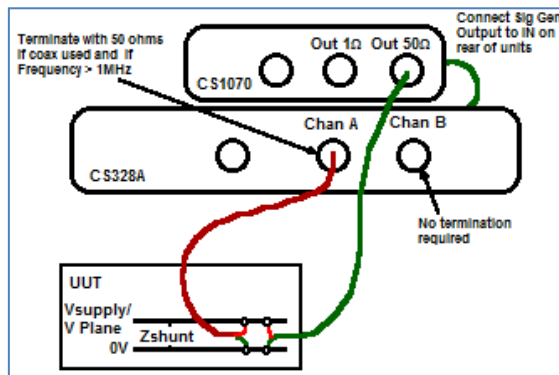

Note that you need to make a 4 point measurement - the Channel A ground and signal lines should be connected close to, but not on the signal generator ground and signal lines. After connecting up the CS328A and CS1070 to the UUT as above, configure the FRA control panel as follows:

- Choose the Use CS1070 50 ohm signal generator option.
- Power Led selected to Red - the CS1070 will be turned on by the application.
- Analysis Type
- Set to Shunt Impedance. Shunt Impedance is used to measure low impedances from 1 mOhm up to about 20 Ohms. Impedance is plotted.
- Auto Setup
- Set Options/Auto Setup On to ensure that the signal generator offset is correctly set.

Set Sig Gen Amp to give a good SNR, 1V is a suitable starting point. You can use a Sweep Amplitude of Auto, and a Response V Goal of >3mV. Make sure you set the Auto Amp Limit to less than the power supply voltage.

The application automatically turns the CS1070 power on and off (assuming you have the CS1070 link port connected to the CS3288A link port). If

needed you can independently control the CS1070 power enable state by clicking on the Power LED . Green is enabled. Red is disabled.

Notes:

If the UUT is powered, the CS1070 output is automatically set to be a sinking load, and the sine wave signal does not go above the UUT power rail. If the UUT is not powered, the CS1070 will output a signal centered on 0V.

The Signal Generator amplitude is specified in V p-p.

17.5.1.3 Calibration

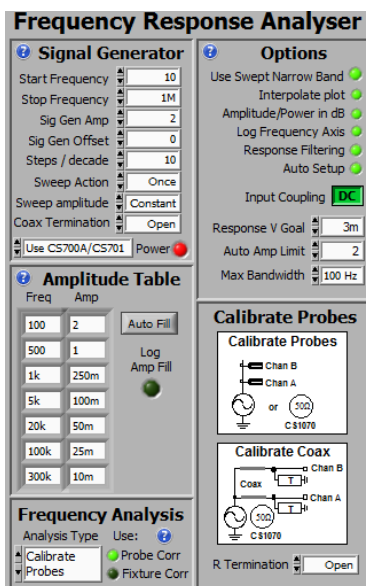
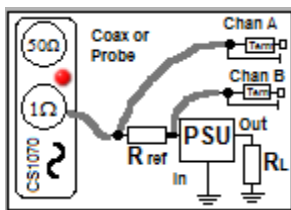
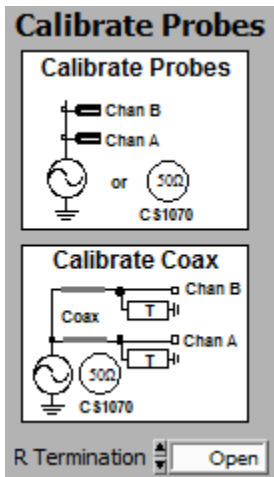

Calibration

- Calibrate Probes
- Calibrate CS1070 1R
- Calibrate Fixture

You can improve the accuracy of the FRA system by calibrating the probes and the fixture and by compensating for the Open Circuit Capacitance of your test system. Calibration results are saved in your setup, and also in any .apc results files. You can save a setup as a .apc file, and when you load the file, you will use the calibration data captured earlier.

Probe Calibration (Short Circuit calibration) - also applies to CS1070 1R

To correct and calibrate Probe non-linearities connect the Sig Gen output to the Channel A and Channel B probe tips, all together. Have no additional impedance to ground (other than coaxial terminations). Connect all the ground clips together. See the Calibrate Probes diagram.

If you are using a SMT fixture with 50 ohm terminated coax cables use a 0 ohm resistor in the fixture to set $Z_{uut} = 0$. If you are using a Shunt connected fixture, have nothing connected to the shunt connection. Calibration automatically takes account of the number of termination resistors. If you are calibrating the CS1070 1R, do not connect the PSU.

Select the **Analysis Type** to *Calibrate Probes*. Setup the Start and End Frequency to capture the frequency range you are likely to be using. You will get best results if you choose the same number of steps per decade (or more) as you intend to use. Interpolation is used as necessary. A Sig Gen Amp of 2V, and Scope Graph ranges of +/-1.5V will give good results. Click Start Sweep, and the Probes or Fixture will be calibrated. Probe Correction is applied when the Probe Corr LED control is on. The LED is dimmed when there are no recorded correction values in the .apc file.

A typical probe calibration setup is shown to the left.

Calibrating the Open Circuit Capacitance

This is best done after a Probe Calibration. Setup your test jig as it will be, but do not connect **Z_{uut}**. Set the Analysis type to Capacitance/Inductance, and the L-C Display to C - Resr. Set C Open to 0. Start a sweep, click Fit on

the Spectrum Display to show the Capacitance values. You will only be able to measure this above about 10 kHz. Note the value - it is the open circuit capacitance. Enter this value into the C Open field. A value of 1pF is entered as 1p. If you run the sweep again the Capacitance graph should show approximately 0 pF. Next do a fixture calibration for maximum accuracy.

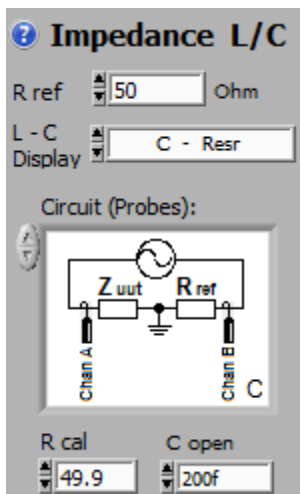

The setup when using probes:

Fixture Calibration (known impedance calibration)

Any test arrangement you use, for example scope probes or an SMT test fixture will have additional parasitic resistance, capacitance and inductance in the fixture and cables. We would like to de-embed these parasitics.

Use the Impedance Setup that you intend to use (Probe or coax, Circuit A, B or C).

R cal replaces Zuut. By knowing Rcal, we can estimate the additional parasitic elements, and compensate for them. Data is recorded in the .apc file, so do a file Save As.. and save the setup for later use.

Select the Analysis Type to **Calibrate Fixture**. Select the Circuit you intend to use. Type in the two known values **R ref** and **R cal**. R cal substitutes for **Zuut**. Ensure the value you use is accurate. You can only use Fixture Correction when the Circuit you used in calibration matches the circuit you are using to test with. R ref and R cal should have low parasitic L and C.

To do the Fixture Calibration:

1. You **must** do a Probe Calibration before doing the Fixture Calibration, and have **Probe Corr** on **Probe Corr**.
2. Find the Open Circuit Capacitance as explained above and enter it.
3. Set the Analysis Type to **Calibrate Fixture**.
4. Choose the correct measurement circuit. Set up R cal (Zuut) and R ref as shown in the diagram, enter the values. Set the frequency range to be same as used for Calibrate Probes. Use Narrow Band. Setup Scope display to capture signal (+/-1.5V should do it). Set up Sig Gen amplitude (2V should do it).

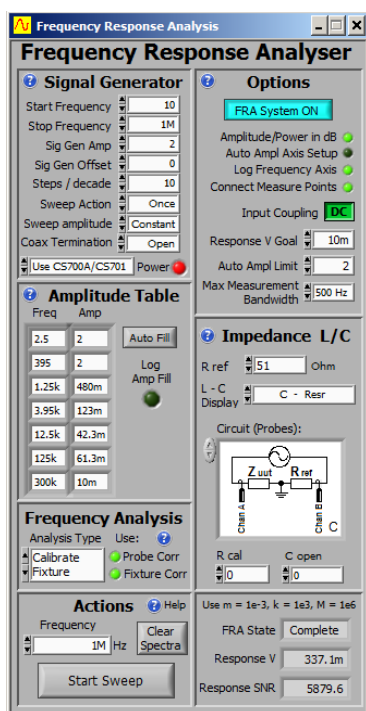

5. Click Start Sweep. The system will measure and display the R ref value including parasitics. Make sure the Probe Corr LED is ON.
6. Do Save As.. and save a file name which reminds you of the fixture and frequency range. This setup will save both the Probe and Fixture calibration values.
7. Now set the Analysis Type back to what you wish to measure, (the Fixture Corr LED will automatically have been turned on) and Start Sweep as normal.

You can turn Fixture Correction on or off with the **Fixture Corr** control LED.

A typical probe based fixture correction is shown to the left. We are using Circuit C. Zuut is replaced with 49.9 ohms (Rcal), R ref is measured with a precision multimeter as 47.1 ohm. The open circuit capacitance was found to be 200fF.

17.5.1.4 PSU Measurement Group

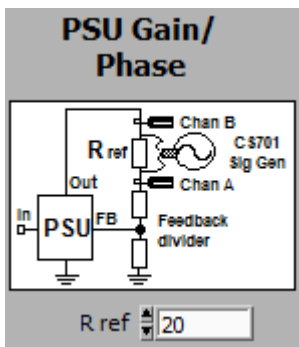

Using the CS701

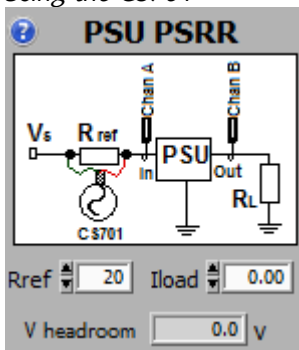

PSU Measurement Group

- **PSU Gain/Phase** - used to measure the Gain/Phase of power supplies, where the signal is injected across a resistor in the feedback path. Can only be used with the CS701 or an isolated CS1070.

See the examples at the end of this section.

Rref is the value used to inject the signal across, which is in series with the feedback chain. Useful values are 20 - 50 ohms.

- **PSU PSRR** - used to measure the Power Supply Rejection Ratio of power supplies. With a CS701 (NOT the CS700A) you inject across a resistor in series with the power supply. With a CS1070, current (<1A) is provided by the CS1070. The PSRR is the ratio of the input voltage perturbation to the output response. It is a positive number expressed in dB. Generally power supplies will have high PSRR at low frequencies dropping off as frequency increases. To measure the PSRR of PSU alone, make sure any input capacitors are the minimum required for stability.

Use the CS701 to measure the PSRR (Power Supply Rejection Ratio) of low current (< 500 mA) regulators. A separate Power Supply sources V_s for the test. The CS701 applies an AC voltage across a series resistor which is sourcing current to the **Unit Under Test (UUT)** from V_s . This requires isolation, and the CS700A **cannot** be used. Connect up the system as shown in the system diagram. **Rref** is the series resistor across which the AC signal is impressed. You need to make sure the separate power source supplying V_s has an output voltage > $V_{in}(\text{psu}) + V_{\text{headroom}}$.

After connecting up the CS328A and CS701 to the UUT as shown in the system diagram, configure the FRA control panel as follows:

- Use CS700A/CS701 A CS701 is required. A CS700A cannot be used.
- **Rref**
The series resistor across which the CS701 signal is applied. It is preferable to connect the BNC shield to the V_s side of Rref. Suitable values for Rref range from 5 ohms to 50 ohms. Make sure the voltage drop across Rref does not exceed 2V. For example with 50 ohms, you can source a maximum of 50 mA. With 5 ohms, you can source a maximum of 500 mA. The CS701 signal is applied via a 50 ohm series resistor, and so will be attenuated by Rref. With a 5 ohm Rref, maximum impressed voltage is 630 mV p-p. With a 50 ohm series resistor the maximum is 3.5 V p-p. The assumption is that the sourcing supply is low impedance to reflect this impressed voltage to the UUT.
- **Iload**
Estimate the load current based on the output voltage and load resistance, or just measure it. The load value is used to estimate V headroom.
- **Sig Gen Amp**
Set the AC signal voltage used to excite the UUT input supply. This should be set to the minimum needed to get a good Response SNR. You can also set Sweep Amplitude to Auto. A target stimulus of 3mV is suitable.

Using the CS1070:

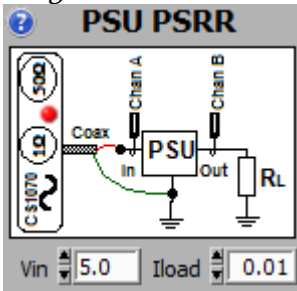

- **Use CS1070 1 ohm**
Select to use the CS1070.
- **Power** If needed you can independently control the CS1070 power enable state by clicking on this LED. Green is enabled. Red is disabled. The application automatically turns the power on and off as required.
- **Vin**
Is the required input voltage.
- **Iload**
Is the estimated total current load of the UUT. It must be under 1A.
- **Sig Gen Amp**
Use a value that results in a useful SNR >5, but as small as you can manage. 0.5V is a good starting point. . You can also set Sweep Amplitude to Auto. A target stimulus of 3mV is suitable.

Using the CS700A/CS701:

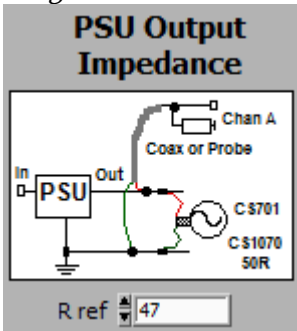

- **PSU Output Impedance** - used to measure the Output Impedance of passive or powered Power Supplies and power planes. Uses a Shunt Impedance measurement when using the CS701 or CS1070 50 ohm, and a sense resistor when using the CS1070 1 ohm. Using the CS1070 1 ohm allows higher current testing, and returns both impedance and phase.

Notes:

If the UUT is powered, the CS1070 output is automatically set to be a sinking load, and the sine wave signal does not go above the UUT power rail. If the UUT is not powered, the CS1070 will output a signal centered on 0V, unless a DC current is specified (+ve for below 0V, and -ve for above 0V, as it is a load current).

The CS701 output is not offset. You can manually offset it using the Sig Gen Offset value. The maximum voltage rail value should be <3.5V.

Rref is the Signal Generator series impedance, including any external resistors. If you are using coax, the maximum PSU Vout is 1.8V, or 3.5V when using an oscilloscope probe.

Using the CS1070:

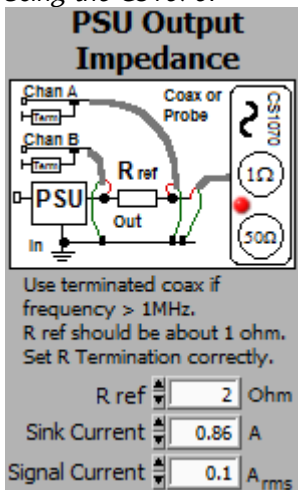

The CS1070 1R output allows the **Sink** and AC signal currents to be set directly. The CS1070 measures the rail voltage before applying current. Make sure the CS1070 input power supply voltage is at least the rail voltage + 3V.

Optimum power transfer, performance and minimum EMC result when the output impedance of the power supply is matched to the input impedance of the load. Simply adding capacitance to the output of the power supply may be counter-productive as it can lower the phase margin of the supply. The optimum goal is that the impedance of the power plane matches the impedance of the power supply, which matches the load impedance. Using the FRA, you can measure the plane impedance, and then use capacitors and/or inductors with appropriate ESR (or series resistors) to match the power supply to the plane, and to the load.

The output impedance does determine the voltage rail ripple generated by current demand at a particular frequency. It is $V_r = Z I_r$.

Using the CS1070:

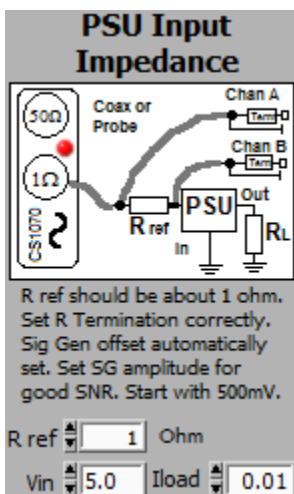

- **PSU Input Impedance** - used to measure the Input Impedance of passive or powered Power Supplies. You must use the CS1070 1R output. A maximum of 1A is available. If you need more than 1A, we have an app note on how to do this.

The phase is displayed. A phase of around 0 means a resistive load, -90 deg is capacitive, +90 deg is inductive, and around -180 or +180 is a negative impedance. Switch mode supplies exhibit negative impedance at low frequencies because a positive change in input voltage results in a negative change in current. As $R = +\Delta V / -\Delta I$, the resistance is negative.

PSU's are often preceded by an input filter to meet conducted EMC requirements. A high Q filter has high impedance at the resonant frequency. The filter can resonate with the negative PSU input impedance.

In addition, if the output impedance of the filter is higher than the closed loop input impedance of the PSU, the total gain/phase response of the Filter/PSU will be affected. This may include reducing the gain at the filter resonant frequency, and modifying the phase, and therefore the transient response of the combination, including forcing instability.

If the filter uses ceramic capacitors with very low ESR, the filter Q will be high, increasing the possibility of oscillation. Electrolytic capacitors, with their higher ESR, may be a better solution for the filter (but not the input to the PSU, which demands low transient impedance). The ESR will damp the high Q, and maintain the filter impedance. Alternatively a parallel connected series R-C can be used to damp the filter at the resonant frequency. The R serves to absorb the resonant current, while the C ensures the loss is not at lower frequencies.

The FRA can be used to measure the output impedance of the filter (short the input to do this) and the input impedance of the PSU without the filter. You can make sure the filter Q is not high, and that the Filter output impedance is always lower than the PSU input impedance.

17.5.2 FRA Actions

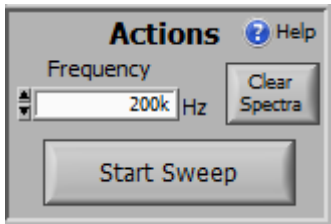

FRA Actions

Once you have setup the FRA Control Panel, click **Start Sweep** to begin the capture process. If you have **Auto Sweep Amplitude**, or **Auto Setup** selected, the **Start Sweep** will initiate measurement of the current environment, before actually starting the sweep - you can see the current state in **FRA State** **Idle**. You can clear the Spectrum Display by clicking **Clear Spectra**. The current frequency is displayed, and you can over-type this to change the Signal Generator frequency if you want.

17.5.3 Signal Generator Control

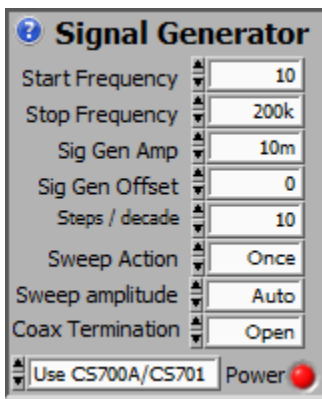

Use this panel to setup the FRA frequency range, amplitude, offset and sweep method. These controls work in parallel with the Signal Generator Control Panel.

Start Frequency

the start of the sweep frequency range.

Stop Frequency

the completion of the sweep frequency range.

If the ratio between Stop Frequency and Bandwidth is > 500 000, then the actual stop frequency will be reduced.

Sig Gen Amp

the default Signal Generator output amplitude in V p-p.

See the **Sweep Amplitude Control** below on how this might be varied.

Sig Gen Offset

the DC voltage by which the Signal Generator is Offset.

If using an electrolytic capacitor use a value of 0 - 1V. You can also use this to offset a power supply up to 3.6V for live power plane impedance testing.

Steps/Decade

sets the number of frequency steps per decade. If Log Sweep is on, these are spread logarithmically, otherwise linearly.

Sweep Action

sweeps once or repeatedly from the start frequency up to the stop frequency.

Sweep amplitude

sets how the amplitude will vary with frequency:

Constant, the Sig Gen Amplitude is set by Sig Gen Amp.

Auto, the system measures the gain of the Device Under Test at selected frequencies, , and then carries out the sweep, varying the amplitude

dynamically to achieve the Response Voltage Goal.

The output amplitude is limited to a maximum of Auto Amp Limit. In some gain situations this may result in instability, so the limit should be reduced.

AutTable is the same as Auto, but at the completion of the sweep the calculated Frequency/Amplitude profile is transferred to the Table, and the Table method is turned on. The Table amplitude control runs much faster.

The **Table** sweep amplitude method may be used when there is instability, or you want control of the Amplitude vs Frequency sweep.

Coax Termination

This control determines if you are using terminated coaxial cable to make connections to the UUT. Leave as **Open** if you are using Probes, or no termination. Set to **25, 50** or **75** ohm dependant on what you have connected. The FRA automatically compensates for the termination impedance when calculating the signal generator output amplitude with its 50 ohm series impedance.

Use CS700A/CS701

This control determines if you are using a CS700A/CS701, or the CS1070 Amplifier with 50 ohm output, or the CS1070 with the 1 ohm output.

Power

Click to **Green** to enable the CS1070 output. Click to **Red** to disable the CS1070. When disabled the CS1070 can stay connected to the load which has a voltage applied to it, as long as the CS1070 power supply is greater than 3V higher than the load voltage. The CS1070 link input must be connected to the CS328A link output.

17.5.4 Options

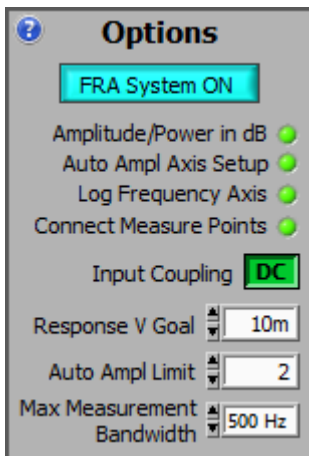

Use this panel to setup how the Spectrum Display looks, and Amplitude options.

Click on the LEDs to change settings. Hover to see help for a control (if *Settings/Display Tools Tips* is on).

All panel controls work in parallel with the standard controls, which you can still continue to use.

FRA System ON

Enables the FRA. Set this ON, and the FRA measures the signal coherent with the signal generator while excluding all other frequencies.

This option gives the best dynamic range. If not selected, the Spectrum Display shows wideband results, and dynamic range reduces. PSU, Impedance and component value measurement require **FRA System ON**.

Amplitude / Power in dB

selects dB or Volts amplitude axis.

After changing the value run the Sweep again to plot using the alternate units.

Auto Ampl Axis Setup

Automatically measures the DC on any signals, estimates the AC signal amplitude and then sets up the graphs appropriately.

After completing the plot, the A and B channel 'Fit' commands are run to fit the Spectrum display. After the first Auto Setup, you can turn the control off, and make small adjustments yourself.

Note that Ctrl Up Arrow and Control Down Arrow zoom vertically on the tracer position, which can be handy to see detail.

Log Frequency Axis

selects a Log or Linear Frequency axis.

Connect Measure Points

draws a line between each frequency/amplitude point and the next to improve the look of the graph. If you want to see just the measurement points, turn this option off.

Input Coupling

Sets DC or AC coupling for the two channels (you can still set channels individually using the Cleverscope Control Panel). If the signal being probed exceeds +/-24 V DC you will need to use AC coupling. The AC -3dB lower cutoff frequency is 5 Hz (1x) or 0.5Hz (10x).

Response V Goal

This is the response voltage goal. Ideally it should not alter the system performance but result in good Signal to Noise Ratio (SNR). For power supplies a response goal of 3- 10 mV is appropriate. For Passive devices such as filters, transformers etc, use 500 mV. The Response V Goal is used by Sweep Amplitude = Auto to achieve the correct Stimulus. If the SNR is <3, the system will automatically reduce the Bandwidth. Alternatively you could increase the Response V Goal, provided it does not affect your system.

Auto Amplitude Limit

When using Auto or Table methods for determining the signal generator amplitude, an absolute limit of this value (in V p-p) will be applied.

Max Bandwidth

The Frequency Bin bandwidth is set automatically as the sweep proceeds.

You can limit the maximum bandwidth used to improve collection of low amplitude signals. Increasing the bandwidth reduces sample collection time, but also reduces the dynamic range. Reducing the bandwidth increases sample collection time and dynamic range, allowing you to measure smaller signals. Usual values are 1kHz or 100 Hz.

17.5.5 Amplitude Table

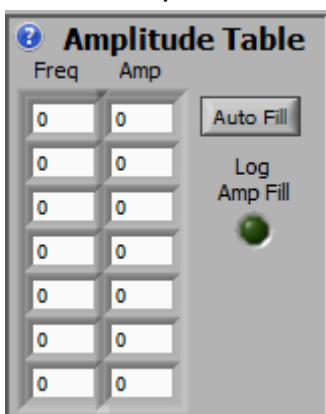

Use this panel to setup the table used to set the amplitude when the **Sweep Amplitude** control is set to **Table**.

The Table is used to generate an open loop varying frequency/amplitude plot to compensate for gain variations which are not easily handled by the Auto method of amplitude control.

Most amplifiers and power supplies have high gain at low frequencies, falling off as frequency increases. If the gain includes discontinuities, or the signal levels are very low, the table is a good approach.

Type values into the Frequencies or Amplitudes entries. The signal generator does linear interpolation between the first two frequencies that straddle the output frequency.

Freq (Frequencies)

contains up to 7 frequencies with corresponding Amp (Amplitude) values.

Enter values in ascending order. Overtyping as necessary. You don't have to fill in all entries. Just make sure that a pair of frequencies straddle the frequency range you will be using.

Auto Fill

interpolates from the first pair in the table to the last pair.

Log Amp Fill

determines how the amplitude values are interpolated - log or linear.

Many amplifiers have a 20 dB/decade reducing gain characteristic and using a log fill can compensate for this.

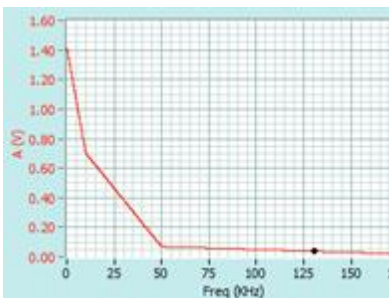

Here is an example plot using 4 values, sweeping from 0 to 200 kHz.

17.5.6 Measurements

This panel has been covered under the Frequency Analysis panel discussion. For Completeness here are the panels.

Use CS700A/CS701 Use CS1070 50 ohm Should not be used for PSU Input Impedance

RMS Amplitude
Power
Power Density
Gain/Phase

Impedance /Phase
Capacitance /Inductance

Shunt Impedance

Calibrate Probes

Calibrate Fixture

Measurements

Probe Measurement

Coax Measurement

Impedance L/C

R ref 47.1 Ohm

L - C Display C - Resr

Circuit (Probes):

R cal 49.9 C open 200f

Shunt Impedance

R Ref is the Signal Generator internal impedance. Used to measure low (<20 ohm) impedances. If using coax set R Termination as used.

R ref 50 Ohm

Calibrate Probes

Calibrate Probes

Calibrate Coax

R Termination Open

Impedance L/C

R ref 47.1 Ohm

L - C Display Phase

Circuit (Probes):

R cal 49.9 C open 0

PSU Gain/Phase

PSU Gain/Phase

R ref

R Ref should be in the range 20 - 50 ohms.

You must use a CS701 isolated Signal Generator.

PSU PSRR

PSU PSRR

Rref Iload

V headroom v

Make sure:
 $V_s > \text{PSU } V_{in} + V \text{ headroom}$
 V headroom includes signal generator AC voltage based on SG Amp applied across R ref.

PSU Output Impedance

PSU Output Impedance

R ref

R ref is the Sig Gen series impedance including external resistors. For use with $V_{out} > 1.8V$, use a CS1070 50 ohm.

PSU Input Impedance

PSU Input Impedance CS701/CS700A

The CS701 or CS700A cannot be used to measure PSU input impedance. Use a CS1070.

Should only be used for Gain/Phase if **Isolated**. Otherwise do **not** use.

Shunt Impedance

Shunt Impedance

R ref is the Signal Generator series impedance. Used to measure low (<20 ohm) impedances. If using coax set R Termination as used.

R ref Ohm

PSU Gain/Phase

PSU Gain/Phase

The CS1070 should not be used for measuring PSU Gain/Phase, as it injects too large a signal. The CS701 does just fine.

To measure the Gain/Phase of higher current or voltage networks, use the Gain/Phase analysis type with the CS1070 Used.

Should not be used for Shunt Impedance. Should only be used for Gain/Phase if **Isolated**.

Calibrate CS1070 1R

CS1070 1 Ohm Output Calibration

1 Ohm probe/coax calibration

Make sure the shared connection is as short as possible. Set R termination if coax is used.

R Termination

PSU Gain/Phase

PSU Gain/Phase

The CS1070 should not be used for measuring PSU Gain/Phase, as it injects too large a signal. The CS701 does just fine.

To measure the Gain/Phase of higher current or voltage networks, use the Gain/Phase analysis type with the CS1070 Used.

PSU PSRR

PSU PSRR

Vin Iload

Set the PSU In volts, and Load current. Sig Gen Offset is set automatically. Set Sig Gen amplitude at minimum to get SNR>10. Start with 500mV. If Coax is used, terminate with 50 ohms at the scope input, but only for Channel Volts < 5V

PSU Output Impedance

PSU Output Impedance

Use terminated coax if frequency > 1MHz. R ref should be about 1 ohm. Set R Termination correctly.

R ref Ohm

Sink Current A

Signal Current A rms

PSU Input Impedance

PSU Input Impedance

R ref should be about 1 ohm. Set R Termination correctly. Sig Gen offset automatically set. Set SG amplitude for good SNR. Start with 500mV.

R ref Ohm

Vin Iload

17.5.7 FRA Information

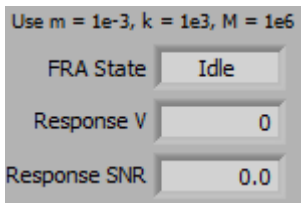

FRA Information

This panel details information about the FRA.

FRA State

The FRA State shows the current state - Idle, Calibrate, wait, Sweep or Complete when carrying out a FRA sweep.

Response V

Displays the measured Response Voltage

Response SNR

Displays the measured Response Signal To Noise Ratio. A value >3 is required, and >10 is good.

17.5.8 Gain and Phase Margin Display

To display the Gain and Phase margins for a power supply click the **FR-0dB** button on the Spectrum Display. This will automatically position the vertical markers on the 0dB gain and 0 degrees phase points on your gain and phase curves. The gain and phase margins, with corresponding frequency are displayed in the marker information area.

17.5.9 -3dB Fo frequency value

You can display and measure the -3dB frequency cutoff point on a frequency response plot by using the **FR-3dB** button on the Spectrum Display. This will automatically position the vertical markers on the -3dB points for Channels A and B. The -3dB frequency values are saved into the marker information area.

17.5.10 Example FRA Setups

These setups should help you in setting up the Cleverscope to make various FRA measurements.

17.5.11 Measuring the Gain/Phase of a Minicircuits 10.7 MHz Band Pass Filter

The Minicircuits filter is designed to be driven by a 50 ohm source with a 50 ohm load. To do this, we used a BNC splitter to drive two 10dB attenuators, with equal length coax then driving the filter terminated with 50 ohms. This is the setup:

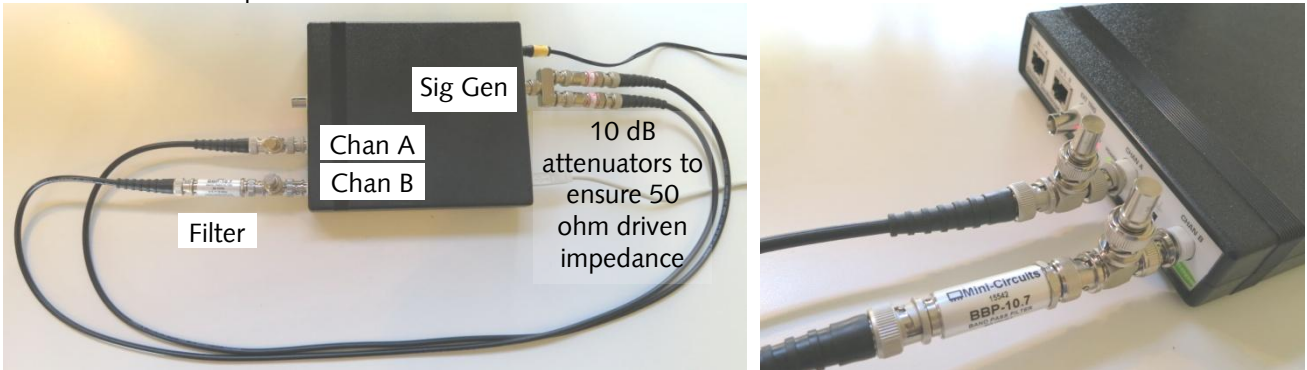

The filter is shown plugged into channel B, with 50 ohm terminators on the two channels.

Here is the response we measure, the markers show the band pass frequencies to be 9.07 - 12.23 MHz:

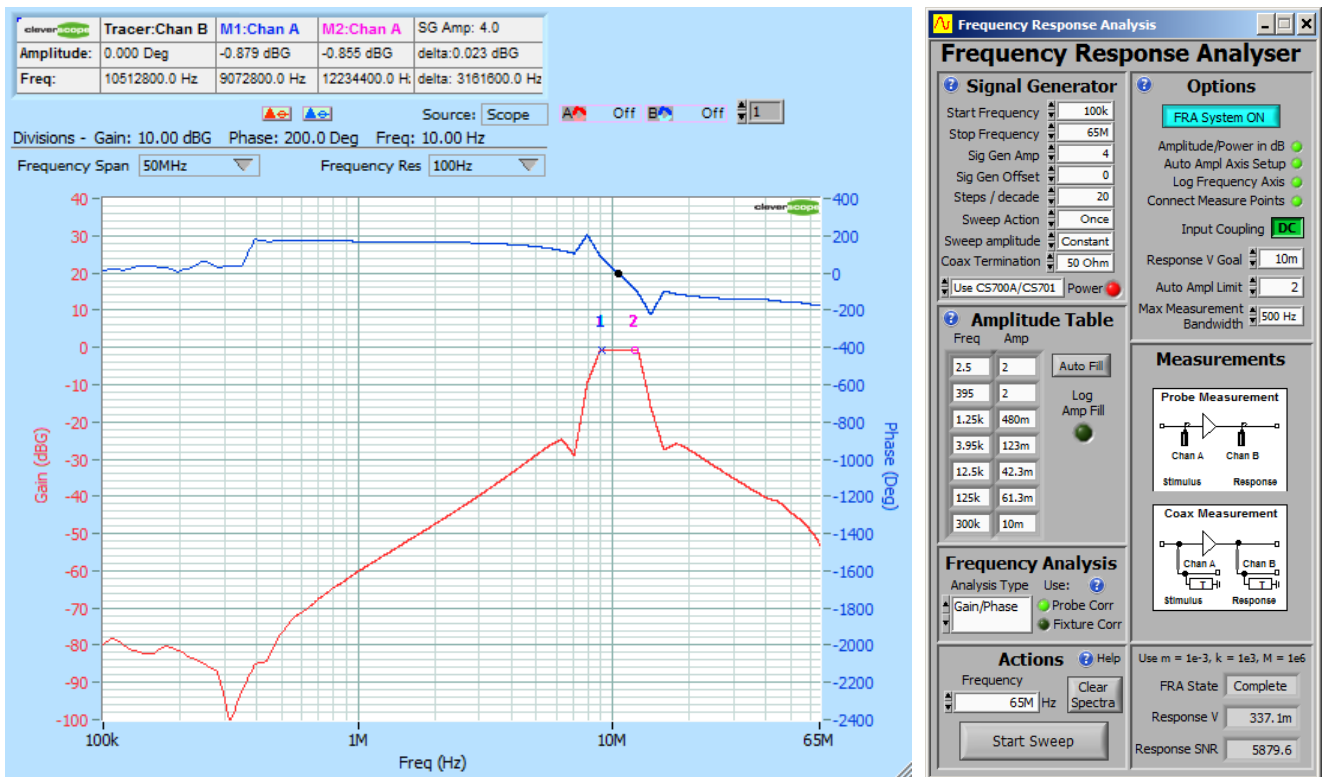

The Stop Band amplitude is -80 dB or so.

The Mini-Circuits insertion loss in the data sheet is shown to the right.

It is inverted with respect to the Gain/Phase. To plot insertion loss with the FRA, reverse the A and B channels.



17.5.12 Measuring a Capacitor, Inductor or Resistor

Steps:

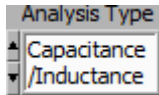

1. Choose
2. We are measuring a 6.8 nF leaded mylar capacitor, using Circuit A, over a frequency range of 1kHz to 5 MHz. Setup the FRA control panel as shown.
3. Connect up the components:

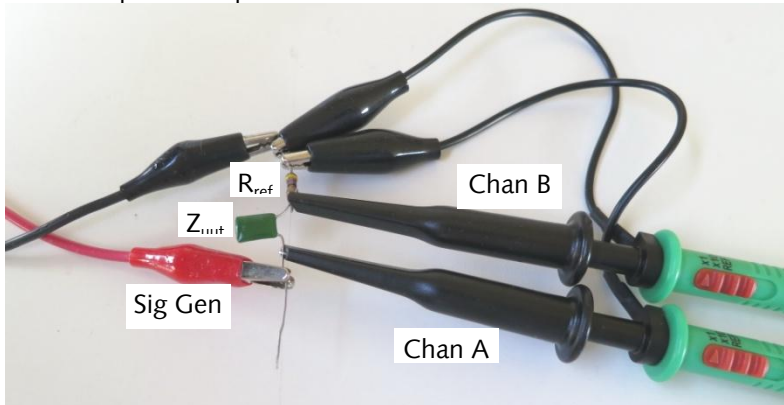

Keep the lead length between the components and probes short to minimize lead inductance.

4. Click *Start Sweep*.

The Scope Display will be automatically setup, and the Spectrum display shows the plot below. You can adjust the view using the axis tools (hover over a control to see help), or use the Ctrl / Arrow keys to zoom in and out on the tracer. The tracer, in black, shows values at that point (3.4 nF at 6.37MHz - half capacitance). The markers (1/blue and 2/red) are placed by clicking '1' and '2'. Tab between channels. Here we see the 6.8nF capacitor is actually 6.5 nF (-4.4%), and falls

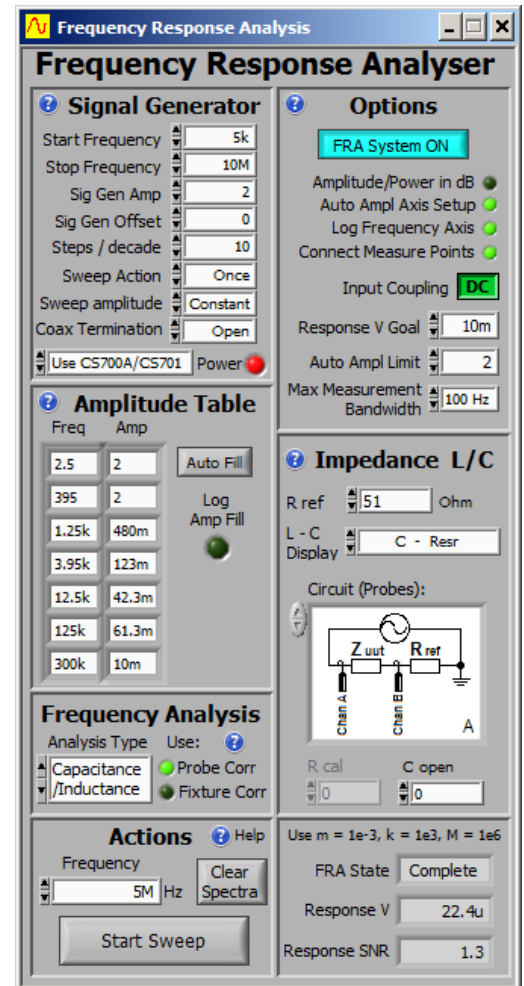

off at about 1.5 MHz. ESR is 34m Ohms at the self resonant frequency.

The self resonant frequency is about 2.5 MHz.

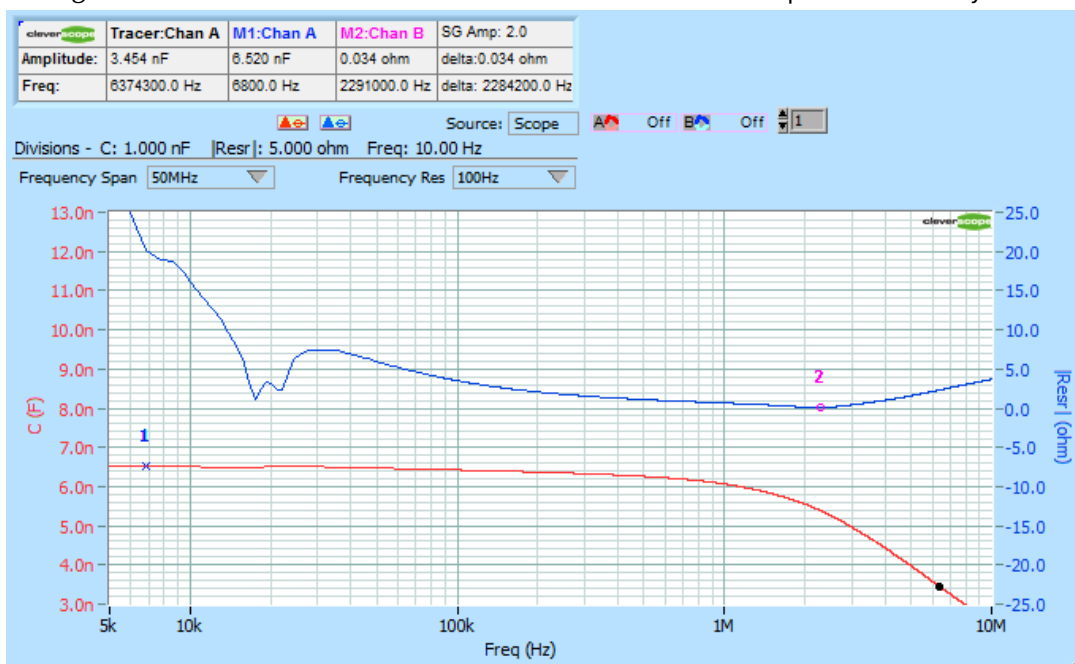

17.5.13 Measuring the Gain/Phase of a live switched mode power supply

The CS701 Isolated Signal Generator is required for this. You cannot use the CS700A. If using the CS1070, make sure it is driven by a CS701, and is fully isolated.

Probes are used for connection. We soldered a UFL socket onto TP6 to inject the signal. Chan A measures the *stimulus*, and Chan B measures the *response*.

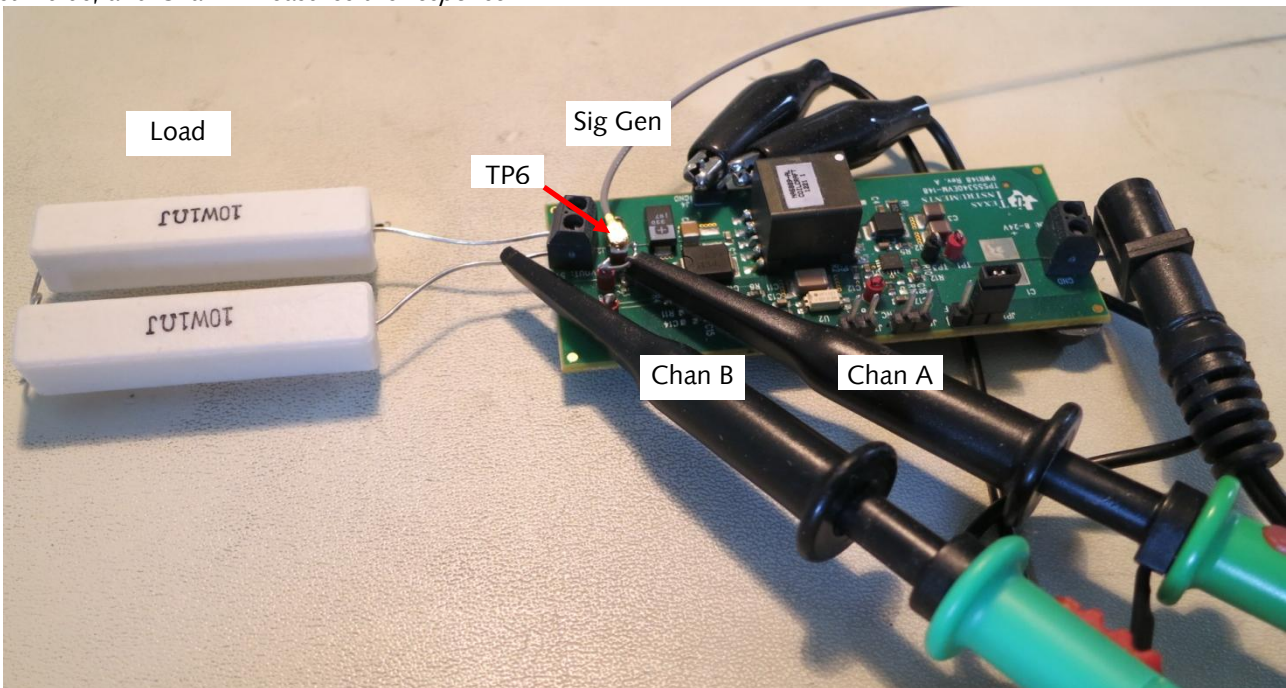
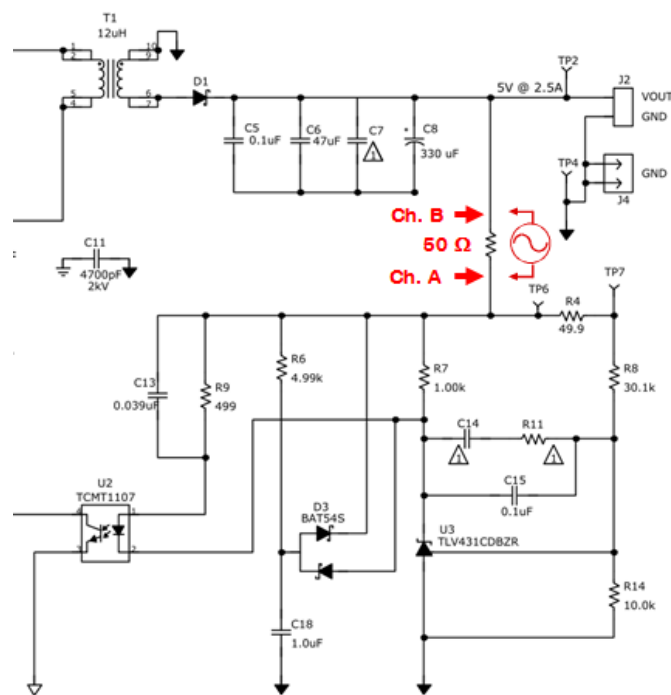
The TI EVM power supply voltage control loop part of the schematic is shown. We have inserted a 50 ohm resistor between the output and TP6, which is the start of the feedback attenuator chain. The FRA setup covers a range of 20Hz to 200 kHz, and is set for Auto Setup with auto amplitude.

Here is the resulting Gain/Phase for a live power supply delivering 2.5A out, at 5V:

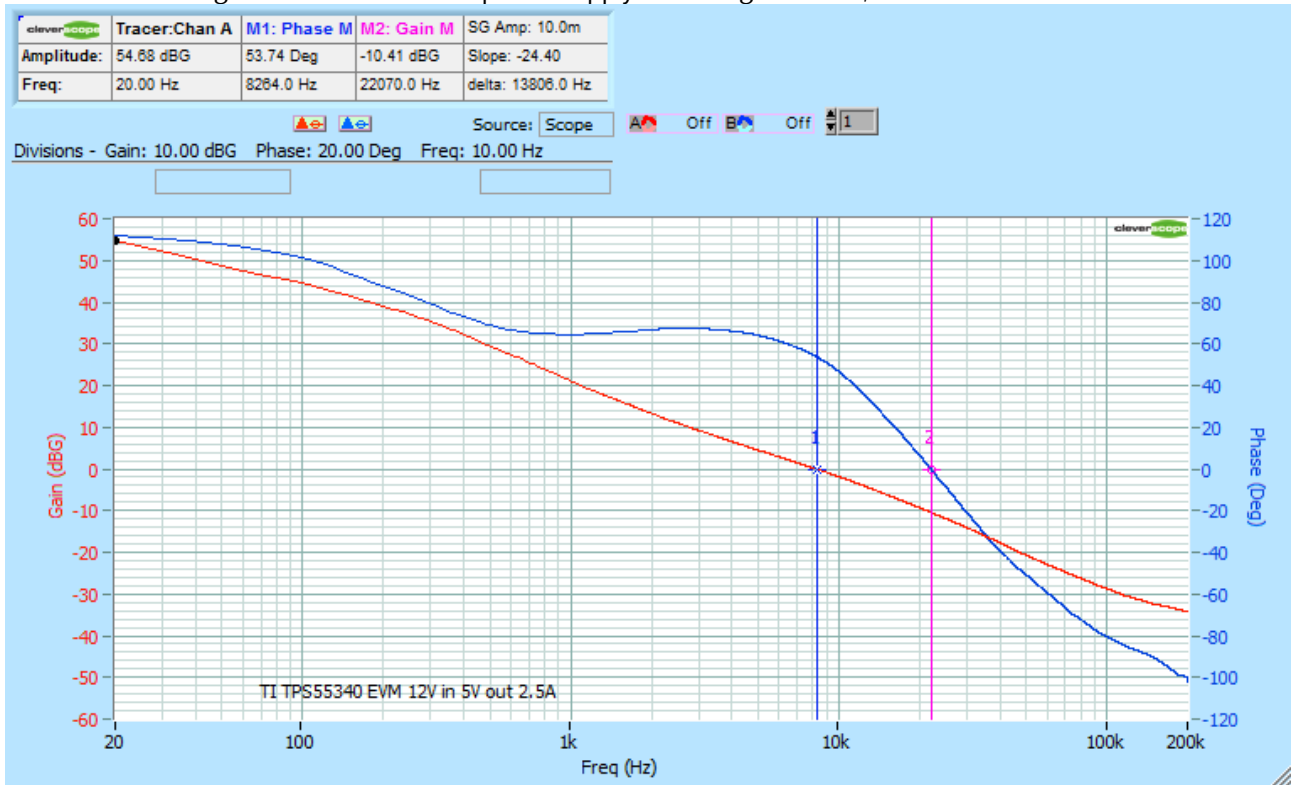

Click the **FR:0dB** button on the Spectrum Display to show the Gain and Phase Margin Markers. Notice the Phase Margin is 53.7 degrees, which is in the optimum range, while the Gain Margin is -10 dB which is adequate in allowing for component and temperature variation whilst ensuring stability.

The gain at low frequencies is upward of 55 dB. The relatively small bandwidth of about 1 kHz (gain >20 dB) means output capacitors will be required if there is a current demand at higher frequencies.

18 Signal Generator Simulator [View Menu]

The Cleverscope Signal Generator Simulator provides built-in software generated signals for both the A and B channels that can be used to demonstrate the capabilities of the Cleverscope application software without requiring a Cleverscope Signal Generator hardware unit to be fitted.

If you need to test external units then you can purchase the CS700A Signal generator module or use your own external signal source.

18.1 Signal Generator Simulator Control Window

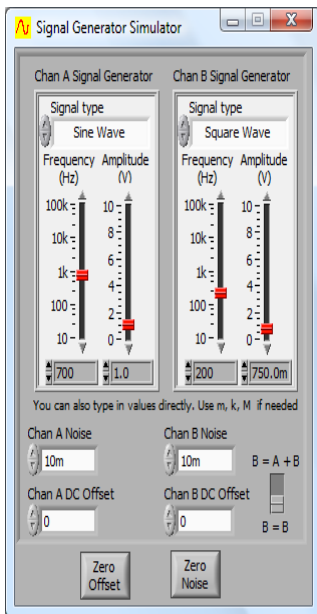

The Cleverscope Signal Generator control window enables you to alter the frequency, amplitude and wave-shape for both channel A and channel B of the internally generated signals.

The signals are not output to real hardware.



The choices for wave-shape are sine, triangle, square and sawtooth. These choices can be selected independently for channel A and channel B using the signal type selection boxes at the top of the signal generator setup dialog box.



The amplitude of background noise can be adjusted using the Chan A or B noise selection boxes.



You can also add background noise and a DC offset to the generated signals to make them more closely approximate real-world signals that might be captured using a hardware unit.



The level of DC offset can also be adjusted using the Chan A DC offset or Chan B Noise offset selection.



Selecting B = A + B using the switch provided at the bottom right of the signal generator setup dialogue box will cause the sum of the channel A and B internally generated signals to be directed to channel B for display.

Note: The offset and noise levels can be zeroed using the buttons provided at the bottom of the signal generator setup dialog box.

18.2 Using the Signal Generator Simulator

The Signal Generator Simulator is connected to Channels A and B internally.

On the Cleverscope control panel.

Click on the **Settings** menu.

Click on **Choose Acquirer and set connection** menu option.

In the **Choose Acquirer and set connection** window click on **Type of Acquirer** and then

Click **Simulated Sig Gen** and Click **OK**.

Click **Auto** in the **ACQUIRE** panel of the Cleverscope controls.

You should see signals appear on both channels if both **A** and **B** are **Enabled ON**.

Adjust the Signal Generator Simulator controls as required.

19 Maths Display [View Menu]

19.1 Maths Display

The Maths Display displays the results of the Maths Equation Builder.

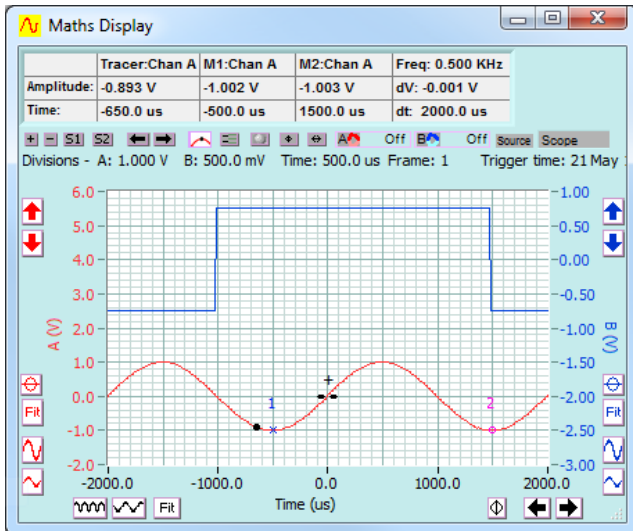

Maths Display has a **Maths Source** control to select the source data from the **Full Buffer**, **Scope**, **Spectrum**, or **Tracking** display.

All the other graph setting buttons work the same as on the other displays.

Refer **Graph Settings** section.

Note that Maths works on the **Spectrum Display** in the frequency domain.

Also if full frame is selected and there is not a full frame then it will just use the **Scope Display** data. **Get Frame** will recalculate the maths using the full buffer. After a full frame transfer using **Get Frame**, you can zoom in on the signal as normal. If a full frame is not used, zooming is limited by the **Scope Display** time resolution.

The **Trigger time** can be used by the Maths system to calculate the time difference between triggers.

19.2 Maths Equation Builder

The **Maths Equation Builder** is used to build equations that process the available analog and digital inputs to generate an output that goes into the channel you choose. You can have up to 10 equations active at one time.

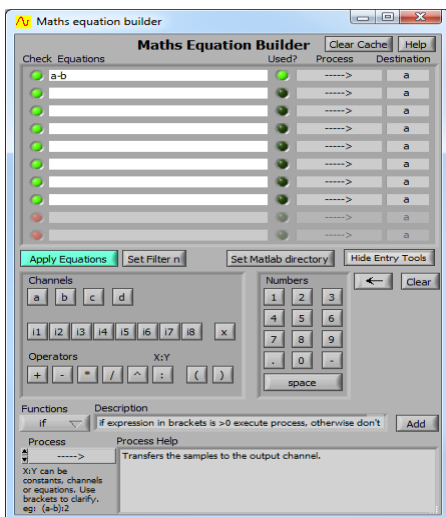

To create an equation, click on the **Equations** row you wish to edit. You can enter equations two ways:

Type in the equation directly. To check that it is valid click on the **Check LED**. A red LED means an invalid equation.

Build up the equation by clicking on the **Channels**, **Operators** or **Numbers** buttons. If you want to use a function click on the **Functions** drop-down button, and select the right one. Click **Add** to enter it into the equation. Use the **Backspace** or **Clear** buttons to edit the equation. The equation will be checked as you go.

Equations work on each individual sample in the channel signal, from beginning to end. Channel signals **a-d** are the analog channels A-D, **i1-i8** are digital input channels 1-8 and **x** is the external trigger.

Note You must enable the **Digital Inputs** if the equations contain **i1-i8** and **x**, otherwise the equations won't work. Intermediate results (even digital ones) are kept as real numbers.

Click **Used?** to enable and disable the equation. Button indicates

green when active.

Choose an output process.

These processes combine the results of previous samples to determine the next value.

The process ----> just transfers the data to the desired **Destination** channel.

Choose the **Destination** channel. Channels **c** and **d** are useful as intermediate storage.

Digital values remain as real numbers until transferred to a digital input, at which point values >0 become true, and values <=0 become false.

The equations are evaluated from top to bottom. Outputs from an equation are used as inputs to the next equation.

Examples:

| Equation | Process | Result |
|-----------------------|-------------|---|
| -a | ----> | Inverts a |
| a+b | ----> | Adds a and b |
| a*d | ----> | Multiplies a and d, e.g. Power = volts x amps |
| sign(-(abs(a-b)-8.5)) | ----> | Returns 1 if the difference between a and b is <8.5, otherwise -1 |
| c:a | X:Y Phase | Returns Phase (in degrees) between c and a |
| b:1 | X:Y Sig Gen | Sets the Sig Gen frequency to value given in b |

Click **Apply Equations** once you are happy with them. Any invalid equations will not be activated.

Click **Set Filter 1** and **Set Filter 2** to setup the filters applying to the Filter 1 and 2 processes.

You can get help on a process by selecting it at the bottom of the window and a process description will appear in **Process Help**. In the descriptions, *samples* means the output of the preceding equation, output into X (if an X:Y pair is used).

The Maths system has a large number of processes. These processes are:

Integral, Differential, Filter 1, Filter 2, Values >0?, DC, Average, Std Dev, RMS, Pk-Pk, Minimum, Maximum, Freq (Amax), Amax (Fo), Phase (Fo), Period, Duty Cycle, Pulse Width, Undershoot, Overshoot, Slew rate, X:Y Pwr Factor, X:Y Phase, X:Y Pwr Watts, X:Y VA, X:Y Var, X:Y A leads B?, X:Y Seq Integral, Seq Time Diff, X:Y Interleave, X:Y Sig Gen, X:Y Autosave.

Help for each process is included in the **Maths equation builder**. Extended signal information is included in the processes.

Of particular note are the **Values >0?**, **X:Y Sig Gen** and **X:Y Autosave** processes.

The **Values>0?** process yields all 0 if no value is >0, and 1 if at least one value is >0. This process can be used to check if any value exceeds a threshold. For example say we were trying to find out if the peak voltage ever exceeded 260V.

We would use this maths equation:

a-260 values>0? b b would now contain 1 if any value was >260V, otherwise 0.

X:Y Autosave can be used to save a graph if any value in A is >0. The current Autosave setup is used. This can be used to log out of range events.

(a-260):1 X:Y b Saves **Scope Display** if any value in a is >260V. b will contain 1 if we
Autosave saved, or 0 if we did not.

X:Y Sig gen can be used to set the Signal Generator to a frequency, amplitude, or waveform.

Freq(Amax):1 X:Y Sig b Sets the Signal Generator to output (i.e. track) an input signal. The frequency output is saved in b.
Gen

This example can take a square wave input (or anything else for that matter) and produce a tracking generator, outputting a sine wave of the fundamental frequency. This could be useful for waveform clean up, transfer functions, making a VCO, etc.

19.2.1 Maths Equations Operators and Functions

The Maths equation editor supports the + - * / ^ () operators.

The : operator is a special operator that is used to separate the two values that are used by some processes.

It supports the following functions, which can be used to construct each Maths equation using the operators. Each operator and function acts on the sample set point by point.

| Function | Explanation |
|----------|---|
| ltz | Returns 1 if value less than zero, otherwise 0. |
| lez | Returns 1 if value less than or equal to zero, otherwise 0. |
| eqz | Returns 1 if value equal to zero, otherwise 0. |
| gez | Returns 1 if greater or equal to zero, otherwise 0. |
| gtz | Returns 1 if value greater than zero, otherwise 0. |
| sign | Returns -1 if value < 0, 0 if value = 0, +1 if value >0 |
| abs | Returns the absolute value of x. |
| acos | Computes the inverse cosine of x in radians. |
| acosh | Computes the inverse hyperbolic cosine of x. |
| asin | Computes the inverse sine of x in radians. |
| asinh | Computes the inverse hyperbolic sine of x. |
| atan | Computes the inverse tangent of x in radians. |
| atanh | Computes the inverse hyperbolic tangent of x. |
| ceil | Rounds x to the next higher integer (smallest integer x). |
| cos | Computes the cosine of x, where x is in radians. |
| cosh | Computes the hyperbolic cosine of x. |
| cot | Computes the cotangent of x (1/tan(x)), x is in radians. |
| csc | Computes the cosecant of x (1/sin(x)), where x in radians. |
| exp | Computes the value of e raised to the x power. |
| expm1 | Computes e raised to the x power minus 1 ((e^x) - 1). |
| floor | Truncates x to the next lower integer (largest integer x). |
| getexp | Returns the exponent of x. |
| getman | Returns the mantissa of x. |
| int | Rounds x to the nearest integer. |
| intrz | Rounds x to the nearest integer between x and zero. |
| ln | Computes the natural logarithm of x (to the base of e). |
| lnp1 | Computes the natural logarithm of (x + 1). |
| log | Computes the logarithm of x (to the base of 10). |
| log2 | Computes the logarithm of x (to the base of 2). |
| rand | Random number between 0 and 1 exclusively. |
| sec | Computes the secant of x, where x is in radians (1/cos(x)). |
| sin | Computes the sine of x, where x is in radians. |
| sinc | Computes the sine of x divided by x (sin(x)/x), x in radians. |
| sinh | Computes the hyperbolic sine of x. |
| sqrt | Computes the square root of x. |
| tan | Computes the tangent of x, where x is in radians. |
| tanh | Computes the hyperbolic tangent of x. |

19.2.2 Maths Equations Processes

The Maths Equation builder supports a number of processes which act on the full array of samples.

| Process | Explanation |
|----------------|---|
| -----> | Transfers the samples to the output channel. |
| Integral | Integrates the samples with respect to time. |
| Differential | Differentiates the samples with respect to time. |
| X:n Filter n | X:n – Filters the samples X using Filter n. n can be a constant or an expression. Use Set Filter n to set the Filter n characteristic. |
| Inst Freq | Derives the instantaneous frequency. Uses a Gabor filter active over 1024 samples to determine the mean frequency at the current sample point. Will not work if there is not at least a partial waveform transition within the 1024 samples. If you are using full buffer maths, a low frequency signal will not work because there are >> 1024 samples per period. |
| Values >0? | Returns 1 if any samples are >0, otherwise returns 0. |
| DC | Returns DC value of the samples. |
| Average | Returns Average value of the samples. |
| Std Dev | Returns Standard Deviation of the samples. |
| RMS | Returns RMS value of the samples. |
| Pk-Pk | Returns Peak to Peak value of the samples. |
| Minimum | Returns Minimum value of the samples. |
| Maximum | Returns Maximum value of the samples. |
| Freq (Amax) | Returns the Frequency of the highest amplitude frequency component (Fo) |
| Amax (Fo) | Returns the RMS amplitude of the frequency component Fo. |
| Phase (Fo) | Returns the starting phase of frequency component Fo. |
| Period | Returns the period of the signal in samples. You need at least one cycle. |
| Duty Cycle | Returns the duty cycle of the signal in samples. You need at least one cycle. |
| Pulse Width | Returns the hi pulse width of the signal in samples. You need at least one cycle. |
| Undershoot | Returns the undershoot of the signal in samples. You need at least one cycle. |
| Overshoot | Returns the overshoot of the signal in samples. You need at least one cycle. |
| Slew Rate | Returns the slew rate of the signal in samples. You need at least one cycle. |
| X:Y Pwr Factor | Returns the ratio of the real power/apparent power (VA) assuming X is current and Y is voltage. |
| X:Y Phase | Returns the Phase, in degrees, between X and Y. If +ve, X leads Y. |

| | |
|---|---|
| X:Y Pwr Watts | Returns the Real Power, in watts, assuming X is current and Y is voltage. |
| X:Y Pwr VA | Returns the Apparent Power, in VA, assuming X is current and Y is voltage. |
| X:Y Pwr VAR | Returns the Reactive Power, in VAR, assuming X is current and Y is voltage. |
| X:Y X leads Y? | Returns 1 if X leads Y in phase, otherwise 0. |
| X:Y Seq Intgrl | Maintains the time integral over sequential captures. Calculates: New Integral = Old Integral + Sample average value * (tn - tn-1) Where tn is the current trigger time and tn-1 is the previous trigger time. All sample in Y must be <=0 to run the integral. If any samples are >0 then the integral is reset. |
| Seq Time Diff | You can have one separate integral per equation line. Returns the time difference between the current trigger time, and the previous trigger time, with 10ns resolution. |
| X:Y Interleave | Interleaves X then Y then Y to return one sample set of twice the sample rate and twice as many samples. |
| X:Y Sig Gen | Sets the signal generator. X is the output value. Y sets the function: 0 = no action, 1 = frequency, 2 = amplitude, 3 = DC offset, 4 = waveform type, 5 = sweep on/off. Values (X) are in: Hz (Frequency); V (amplitude); V (offset); |
| X:Y Autosave | Waveform type: 0=sine, 1 = triangle, 2 = square, 3 = DC, 4 = Off ; Sweep: 0 = sweep off, 1=on. If any samples in X>0, save a graph using Autosave (which needs to have been previously setup). Y selects which graph is autosaved: 0 means current display, 1 = Scope Display, 2 = Spectrum Display, 3= Tracking Display, 4 = Maths Display. |
| X:Y Correlate | Returns the correlation between X and Y, as a half-length data set. |
| X:Y Matlab CS1 CS2 .. CS3.. X:Y Matlab CS4 | Send the signals defined by X:Y to Matlab execution function Cscope1.m ... Cscope4.m. Returned results are sent to destination. |
| Sum | Returns the running sum for the input samples set. Sample n = Previous Sum + Sample n. Previous Sum = 0 for n = 0. Useful for averaging, integration and noise density accumulation. |
| Difference | Returns the running difference for the input samples set. Sample n = Previous Sum - Sample n. Previous Sum = 0 for n = 0. |
| Count | Finds positive going edges, with +50mV up threshold and +10mV down threshold. This hysteresis helps with noise reduction. Increments count on every edge. Count is at 0 at start of frame. Use Markers to calculate the count of a portion of the input signal. Invert the signal and offset for negative edge. |

Where you see X:Y, X is replaced by an equation before the colon, and Y is replaced by an equation after the colon.

Examples:

4*sin(a):i1, 2:(a*d)/3, a:1, 1:c

19.3 Maths Equation Builder Walkthrough

The mathematical functions are useful for visualising information that can be derived from the measured signals. This section describes deriving first the differential voltage across a resistor, followed by conversion of that value to a current, then using a multiply to derive power, and finally by integrating the power to measure energy.

Derivation is very useful in a number of other areas – for example using I and Q signals to demodulate base band signals, using 4 quadrant multiplication to simulate modulation and investigate the resulting signal bandwidth, using filters to estimate what the real world measurement of a conditioned sensor might be.

19.4 Example - Power Consumption [Maths]

A typical power supply delivers 9V to a battery powered Unit Under Test (UUT). Our goal is to measure current, and power consumption, and arrive at the total energy needs of the unit. To do this we use a series resistor (it could be a DC capable current clamp) to measure the current. Because the resistor is in the positive line we need to do differential measurements to see the current.

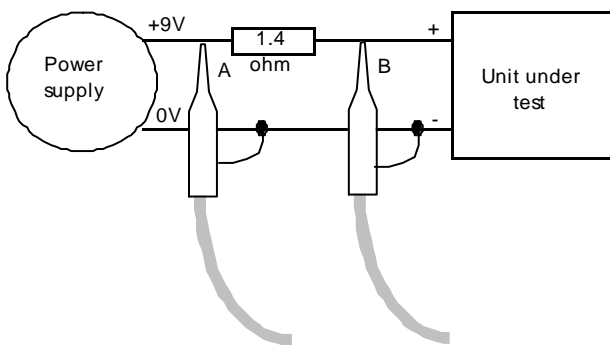

A – Channel A input, B - Channel B input

Here is the graph captured from a typical UUT starting up, configured as in the diagram above.

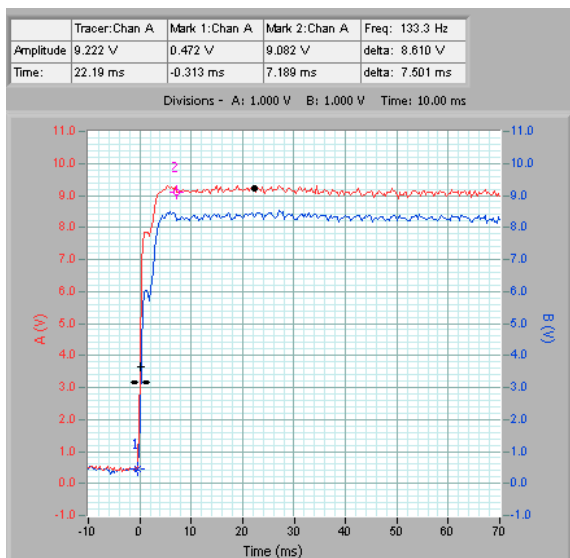

19.5 Example - Deriving the Differential Voltage [Maths]

The differential voltage is calculated from the voltages at test points A and B connected to the Cleverscope via probes on Channels A and B (x1 range).

On Cleverscope Control Panel window click the **View** menu option, click **Maths Equation Builder** in the dropdown list to display the equation builder.

Type the formula directly in the input field or click the required formula input buttons to build the expression. Click **Used?** **Process** and **Destination** buttons to complete setup.



The **a-b** equation subtracts each sample value in channel B at a particular time, from the sample value in channel A at the same time and then transfers it into channel A.

Channel B displays the actual voltage going into the unit being tested.

Click on **Apply Equations** to save the formula.

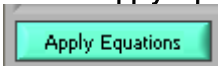

In the Cleverscope Control Panel window click the **View** menu option then click **Maths Display**.

The result of **Maths** with A-B → A is the following graph:

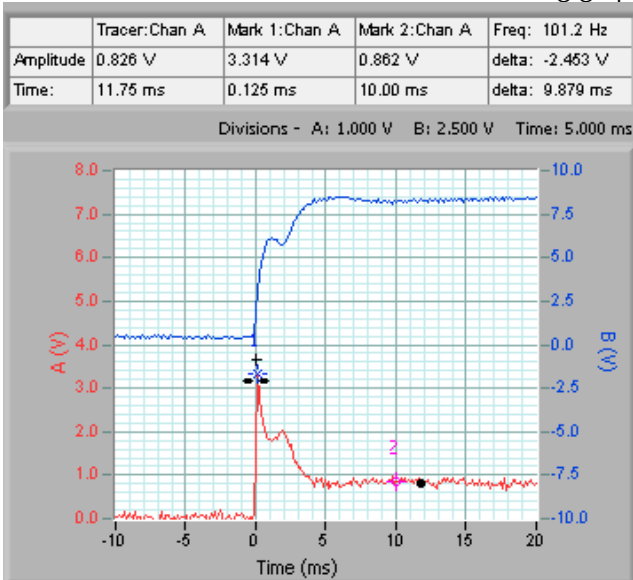

19.6 Example - Deriving Current [Maths]

In the result graph we can see the current demand was initially high, and then fell back following start-up. It would be more useful to have this result expressed in mA.

From $V = IR$, using a 1.4 ohm resistor,

$$I = V/R$$

$$= V \times 1000 \times 1/1.4 \text{ mA}$$

$$= V \times 714 \text{ mA}$$

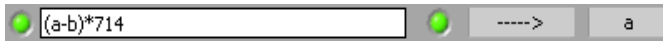

Go to the Maths Equation Builder window.

Enter equation **(a-b)*714**

Click **Apply Equations**

Return to the **Cleverscope Control Panel** window.
On the **Settings** menu, click **Analog Names and Units**.

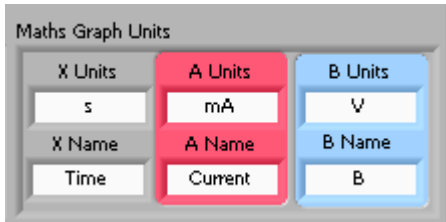

In the **Maths Graph Units** area, change **A Units** to *mA* and **A Name** to *Current*.
Click **OK**.

Note The units and names change immediately on the graphs and information areas.

The A channel graph is much more useful now we can read the current directly.

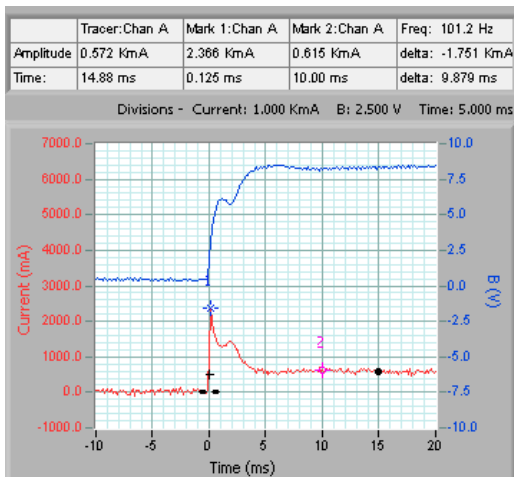

We see the following:

The peak current demand is 2366 mA. (Mark1:Chan A).

The stabilized current demand is 615 mA. (Mark1:Chan A).

The increased current demand lasts for about 5 ms.

19.7 Example - Deriving Power [Maths]

The B channel shows the actual voltage going into the unit.. Many battery modules are rated in AHr which is the design continuous current consumption available for one hour of use.

For example, a 9.6 V (8 cell) NiCad battery pack might be rated at 700 mAHr. This mean that after one hour of 700mA constant current drain the battery terminal voltage will have fallen to 80% of the full charge terminal voltage and the battery will be nearly empty.

For a switch mode power supply we are more interested in the power consumption because the current will vary with terminal voltage. Assuming a straight line reduction in battery terminal voltage (i.e. an average of 90% of the fully charged terminal voltage) we can estimate the energy content of the battery in Watt Hr (or Joules, with constant conversion), and use this to calculate actual battery life.

For the 700mAHr 9.6V battery above, the capacity is:

$$0.9 \times 9.6 \times 0.7 = 6 \text{ Watt Hour, or}$$

$$0.9 \times 9.6 \times 0.7 \times 3600 = 21.7 \text{ kJoule.}$$

Go to the Maths Equation Builder window.

Enter two equations as shown:

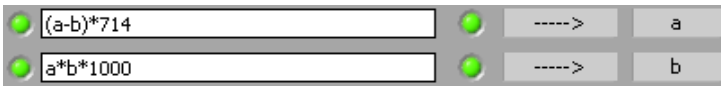

Note The first puts the current into channel A. The second equation runs after the first, and uses the new current values in amps to calculate the power in watts.

Note *1000 is to convert the current in mA into A current in Amps to get power in Watts

Click Apply Equations.

Go to the Cleverscope Control Panel window.

On the Settings menu, click Analog Names and Units.

In the **Maths Graph Units** area, change **B Units** to *W* and **B Name** to *Power*.
Click **OK**.

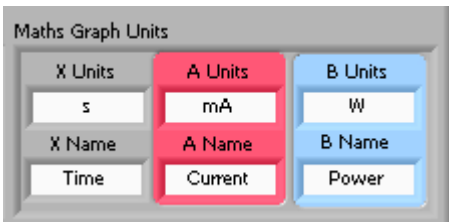

The graph shows the results of the **Maths**, first multiplying $B \times A \rightarrow B$ to get Watts in the B channel, and then re-labelling the B axis to show power:

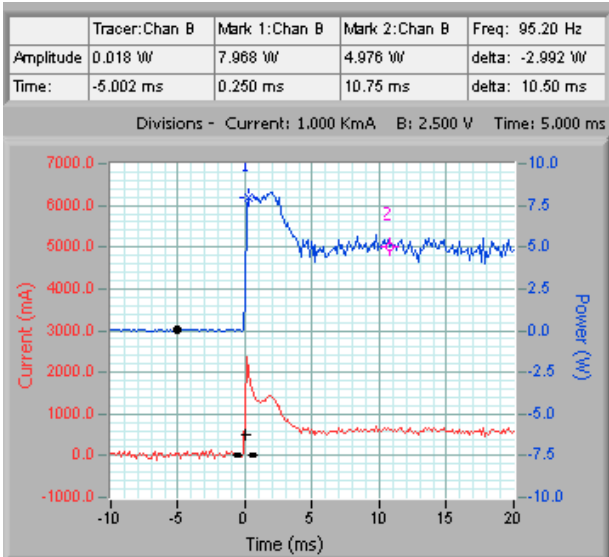

The peak power usage is 8W, (7.968 Mark 1:Chan B) while the normal power usage is 5W, (4.976 Mark 2:Chan B).

If we ignore the initial power pulse we could estimate the battery life at $6/5 = 1.2$ Hours.

19.8 Example - Deriving Energy [Maths]

If the power consumption is varying markedly, we could measure the actual energy consumption, by integrating the power used over an appropriate period. This can be done with the integrating process applied in the Maths equation.

Go to the Maths Equation Builder window.

Enter equations as:



Note The Integral Process is now turned on.

Click **Apply Equations**.

Go to the Cleverscope Control Panel window.
On the Settings menu, click Analog Names and Units.

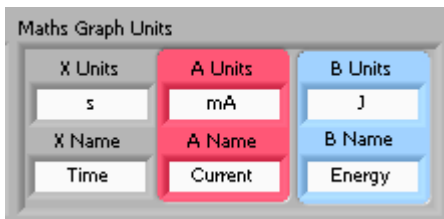

In the **Maths Graph Units** area, change **B Units** to *J* and **B Name** to *Energy*.
Click **OK**.

The resulting graph has the integral applied:

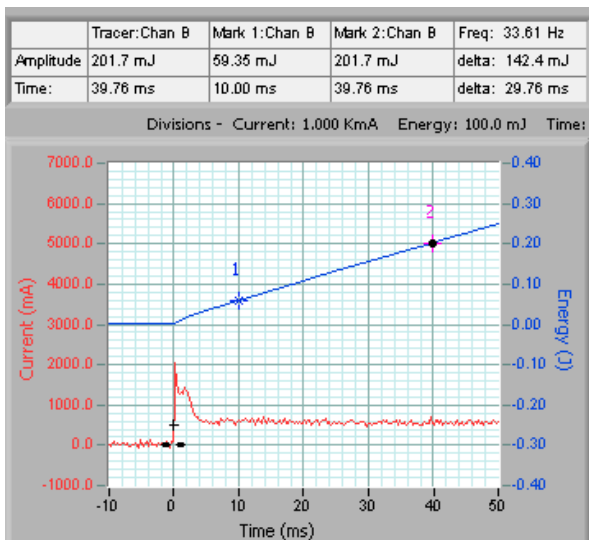

The B axis has been relabelled to Energy (J), and shows energy consumed since the start.

The energy use between Markers 1 and 2 is $201.7 \text{ mJ} - 59.35 \text{ mJ} = 142.4 \text{ mJ}$, used over $39.76 \text{ ms} - 10.00 \text{ ms} = 29.76 \text{ ms}$,

This gives $0.02976 / 0.1424 \text{ s/J}$.

As a very rough estimate, battery life will be:
Life = $21700 \text{ (j)} \times (0.02976 / 0.1424) \text{ (s/j)} = 4,528 \text{ seconds}$, or 1.26 hours.

You can see here the great flexibility and reduction in error that can be achieved by using the mathematical equations, and custom units, to make the graphs far more meaningful than the raw measured voltages.

20 Matlab Usage

Cleverscope includes four processes that can be used to call external Matlab .m functions to considerably extend the capabilities of Cleverscope for analysing waveforms.

Executing Matlab Functions

The maths Equation builder is used to set up the equation line that calls the Matlab.m functions.

Example 1



Pass channels **a** and **b** to Matlab `cscope1.m` function. Return the result to channel **a**.

Example 2



Pass (channel **c** multiplied by 3.2 added to sine(channel **a** times 12)) and digital input 3 to Matlab `cscope2.m` function. Return the result to channel **b**.

20.1 Matlab .m functions

Cleverscope assumes the existence of four Matlab .m functions used for interface. These functions can in turn call other Matlab functions, including user interface activity, if needed. The four functions are named **cscope1.m**, **cscope2.m**, **cscope3.m** and **cscope4.m**.

The functions each have a common header:

Example 3

Function `z = cscope(x,y,n,T0,dt,TrigSecs,TrigPartSecs,Frame)`

This function expects the following values:

x – an array of values input as X in the X:Y

y – an array of values input as Y in the X:Y

n – the number of samples in the arrays X and Y, a scalar.

T0 the start time of the Maths graph as a scalar. For example -0.023 means the graph starts at -23ms.

dt – the sample interval, in s, as a scalar. For example 0.000005 means a sample interval of 5us.

TrigSecs – is the number of whole secs since 12 midnight, 1 January 1904 UTS.

TrigPartSecs – is part seconds to be added to TrigSec.

Frame – is the current Frame number.

z is the array passed back to the Cleverscope maths equation builder.

Watch a demonstration of live exporting to Matlab here www.youtube.com/watch?v=V1ZMLaNtBL8.

Watch a demonstration of live exporting to Matlab spectrograph here www.youtube.com/watch?v=jRP_AuXTR_Q.

Note The lower right portion of the **Help** window of the **Maths Equation Builder** can be copied into a text file to quickly setup a function.

20.3 Matlab Functions - Example 1 Add two channels

Cscope2.m - adds two channels together and returns result.

function z = cscope(x,y,n,TO,dt,TrigSecs,TrigPartSecs,Frame).

z = x + y



Input Signal

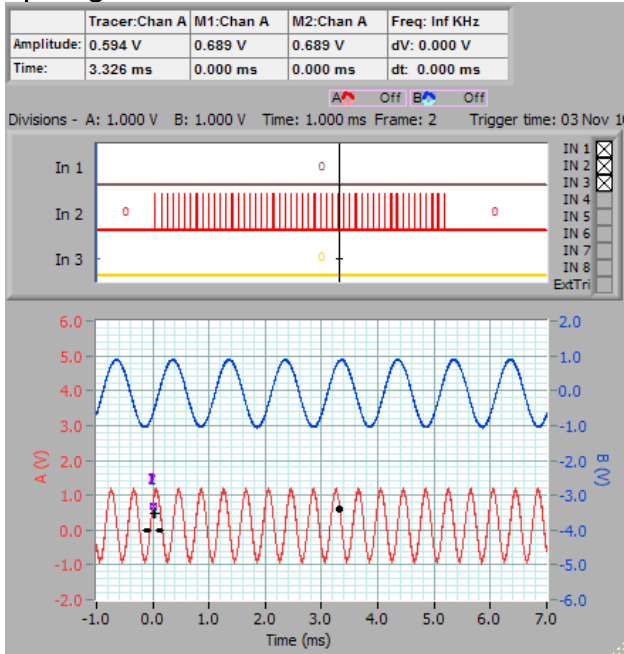

Maths Display result

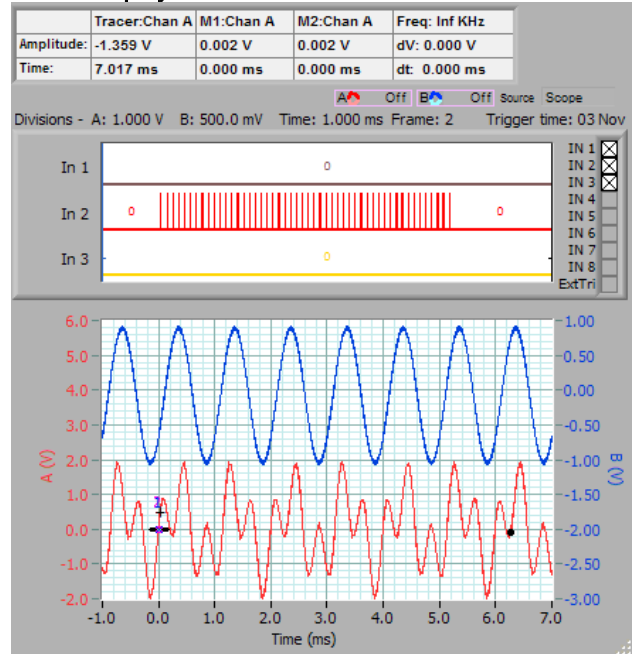

20.4 Matlab Functions - Example 2

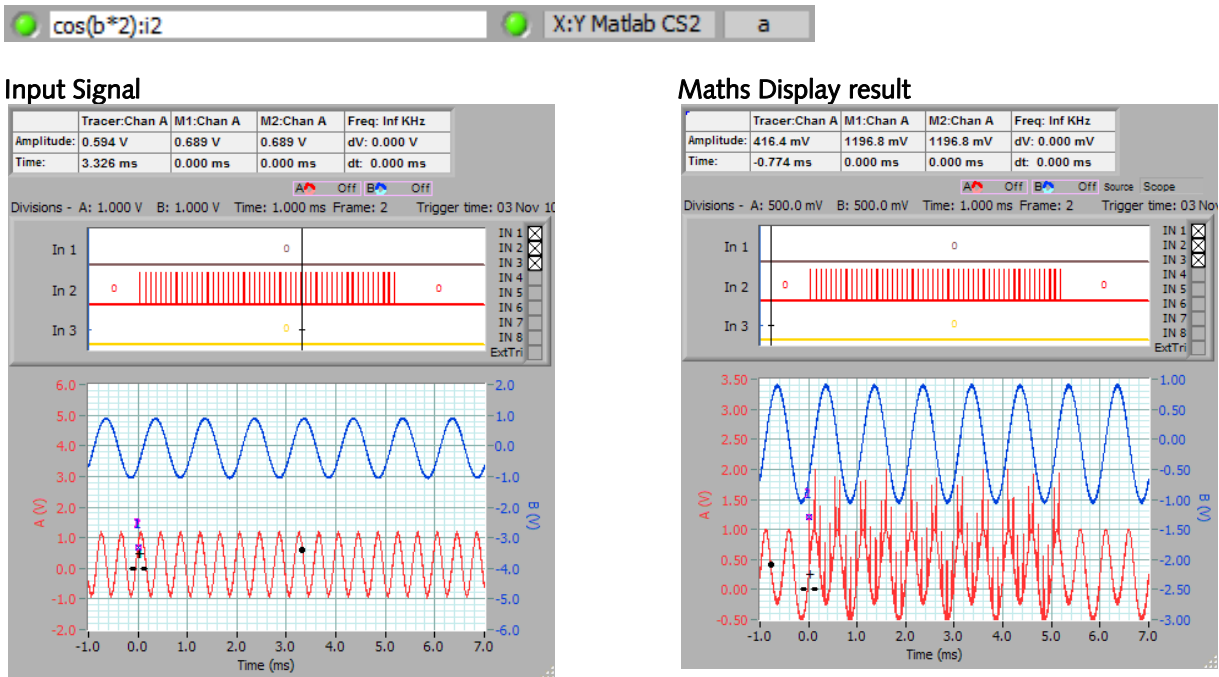

20.5 Matlab Functions - Example 3

Cscope1.m – adds two channels together, returns result, and plots **a** and **y** in red and blue in a Matlab Figure.

| | |
|---|------------------------|
| function z = cscope(x,y,n,T0,dt,TrigSecs,TrigPartSecs,Frame) | |
| z = x + y | |
| time=((0:n-1)*dt)+T0 | % Calc graph time axis |
| figure (1) | % Plot data to fig 1 |
| plot(time, x, 'r', time, y, 'b') | %plot the data grid on |

20.6 Matlab Functions - Example 4

Send more complex arrays to Matlab



Input Signal

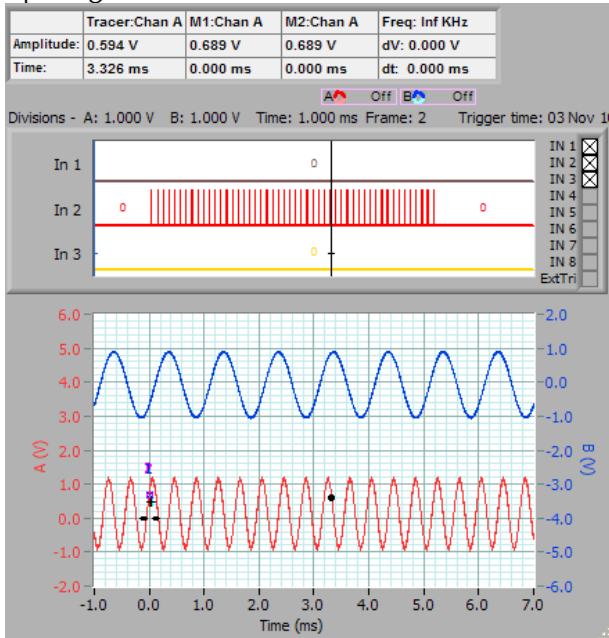

Maths Display result

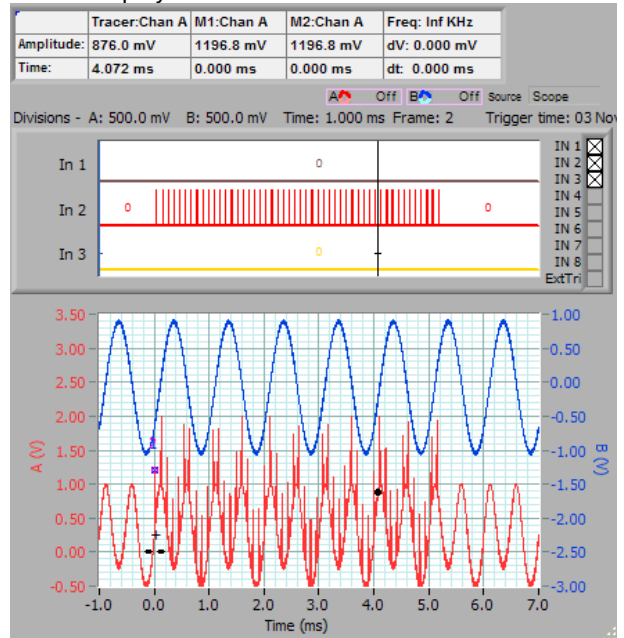

Matlab output:

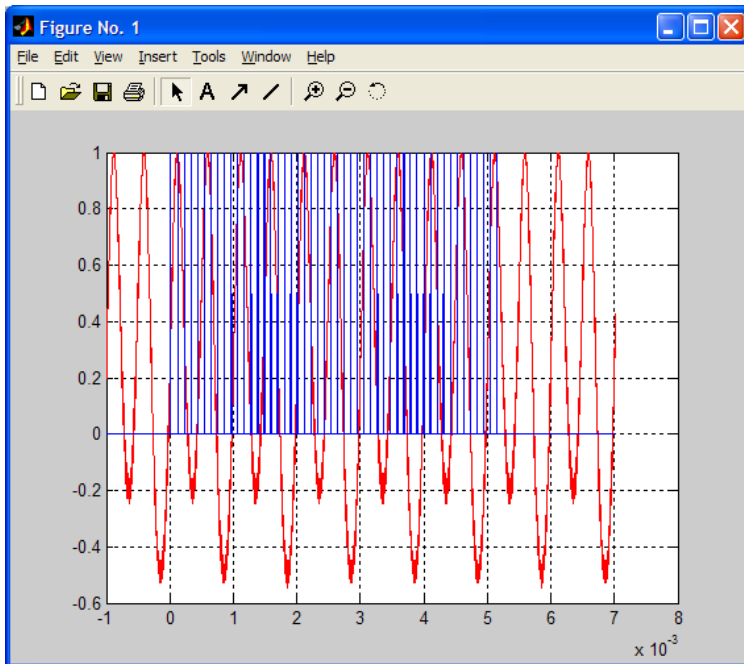

20.7 Using Matlab for Further Processing

We have cscope4.m defined as:

Cscope4.m – plots the spectrogram of channel a

```
function z = cscope(x,y,n,T0,dt,TrigSecs,TrigPartSecs,Frame)
```

```
z = x
```

```
figure (1) % Plot data to fig 1
```

```
specgram(x,512,1/dt,500,475)
```

```
title('Spectrogram')
```



Input Signal – Frequency Chirp

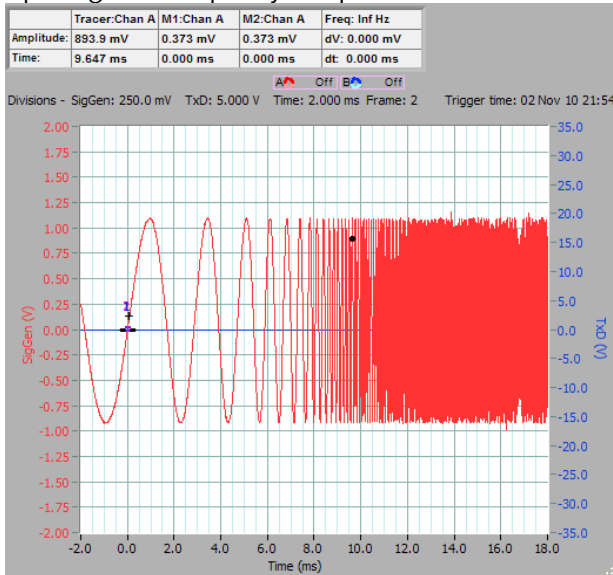

Matlab output Figure

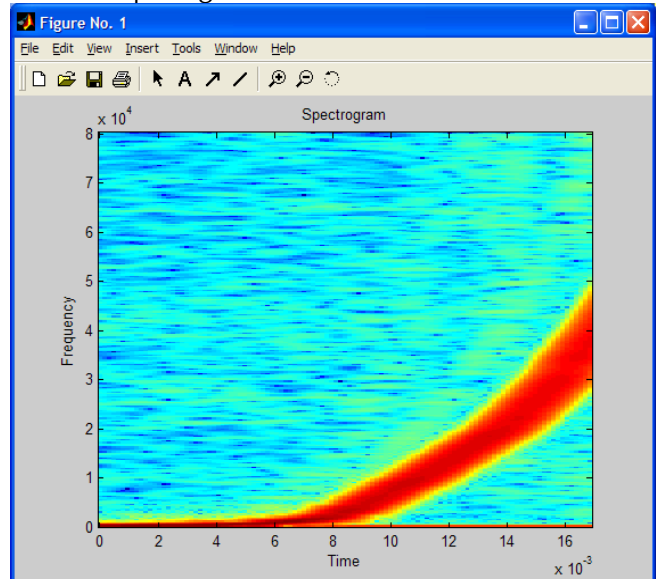

20.8 Conclusion

With up to four processes to call Matlab with, and fully flexibility on the data sent to Matlab, you have a great deal of scope in using Matlab to extend the already high Cleverscope functionality.

21 Protocol Setup

Protocol Setup is via a Protocol Setup Window that contains all the controls to acquire signals from data streams.

Protocol Setup Window

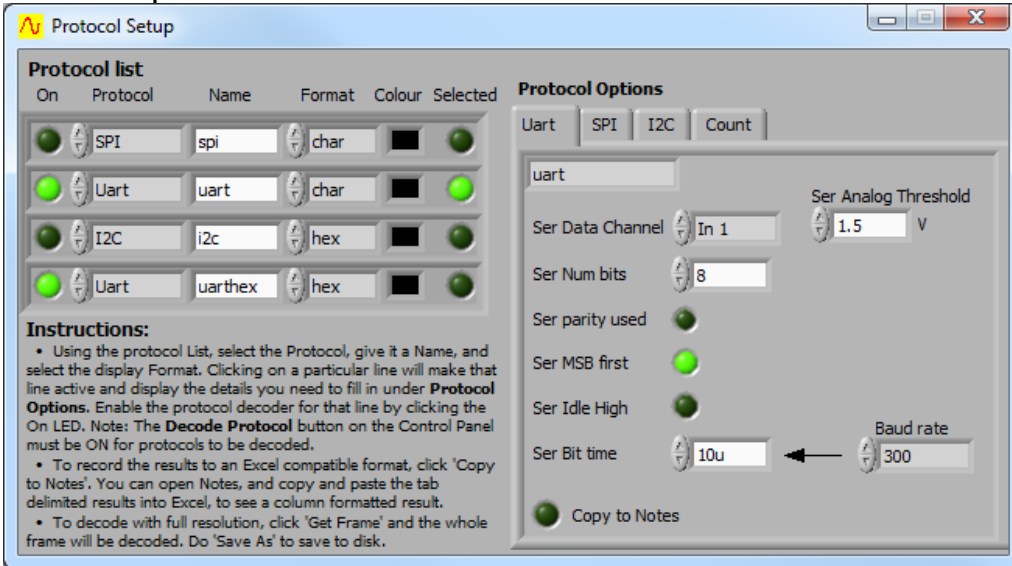

- On** Switches on the Protocol Decode function for each of the protocols being captured.
- Protocol** Click on the arrows or in the field to select the protocol to be decoded. The Protocol Options tab will be set to match the protocol selected.
- Name** Click in the field to enter the required user-defined Name.
- Format** Click on the up or down arrow or in the field to select the Hex, Decimal or character format data display.
- Colour** Click in the colour box to select a colour from the pop-up colour palette.
- Selected** Click on the button to activate the capture. Button turns green when active.
- Protocol Options** Tab is selected when the Protocol is selected.
- UART tab** Settings for serial data streams.
- SPI tab** Settings for SPI protocol data streams.
- I2C tab** Settings for I2C protocol data streams.
- Count tab** Settings for counting-based capture.

21.1 UART Tab

UART Protocol Options Tab

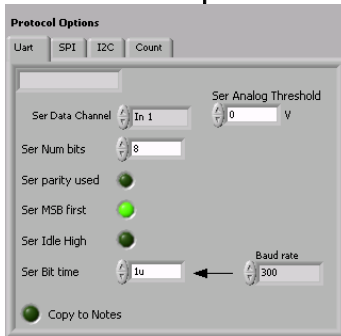

| | |
|-----------------------------|---|
| Name | Displays the Name as set in the Protocol List . |
| Ser Data Channel | Click on the up or down arrow or in the field to select which input is connected to the data stream. |
| Ser Analog Threshold | Click on the up or down arrow or in the field to set the threshold value. |
| Ser Num Bits | Click on the up or down arrow or in the field to select the number of data bits. |
| Ser parity used | Click the button to toggle the switch to 'used' if the data stream uses a parity bit. |
| Ser MSB first | Click the button to toggle the switch to set MSB or LSB first. |
| Ser Idle high | Click the button to toggle the switch to set Idle high or Idle low value. |
| Ser Bit time | Click on the up or down arrow or in the field to select serial bit time OR |
| Baud rate | Click on the up or down arrow or in the Baud rate field to select the Baud rate. Setting the Baud rate will automatically populate the Serial Bit Time value. |
| Copy to Notes | Click the button to toggle the switch to copy the results to notes. |

21.2 SPI Tab

SPI Protocol Options Tab

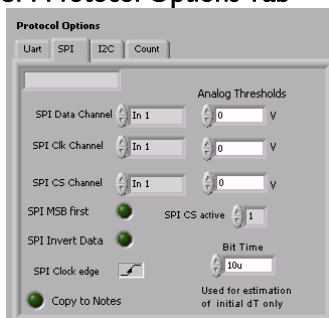

| | |
|-------------------------|--|
| Name | Displays the Name as set in the Protocol List . |
| SPI Data Channel | Click on the up or down arrow or in the field to select the input connected to the data stream. |
| Analog Threshold | Click on the up or down arrow or in the field to set the threshold value. |
| SPI Clk Channel | Click on the up or down arrow or in the field to select the input connected to the clock. |
| Analog Threshold | Click on the up or down arrow or in the field to select threshold value. |
| SPI CS Channel | Click on the up or down arrow or in the field to select the input connected to the CS signal. |
| Analog Threshold | Click on the up or down arrow or in the field to select threshold value. |
| SPI MSB First | Click the button to toggle the switch to recognise MSB or LSB first in the data stream. |
| SPI CS Active | Click on the up or down arrow or in the field to select the CS signal active state ('0' or '1'). |
| SPI Invert Data | Click the button to toggle the switch to invert data signals. |
| SPI Clock Edge | Click the button to toggle the switch to select the active clock edge. |
| Bit time | Click on the up or down arrow or in the field to select likely bit time. |
| Copy to Notes | Click the button to toggle the switch to copy the results to notes. |

21.3 I2C Tab

I2C Protocol Options Tab

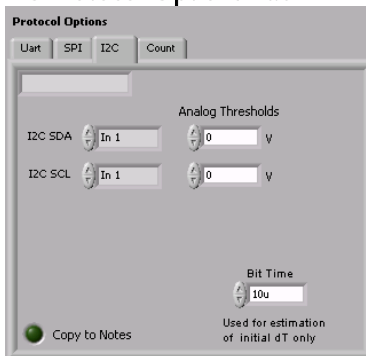

| | |
|--------------------------|--|
| Name | Displays the Name as set in the Protocol List . |
| I2C SDA | Click on the up or down arrow or in the field to select which input is connected to the data stream. |
| Analog Thresholds | Click on the up or down arrow or in the field to set the threshold value. |
| I2C SCL | Click on the up or down arrow or in the field to select which input is connected to the SCL signal. |
| Analog Thresholds | Click on the up or down arrow or in the field to set the threshold value. |
| Bit time | Click on the up or down arrow or in the field to set the likely bit time. |
| Copy to Notes | Click the button to toggle the switch to copy the results to notes. |

21.4 Count Tab

Count Protocol Options Tab

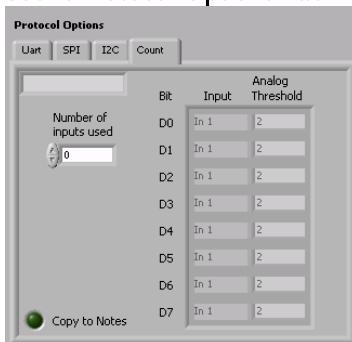

- Name** Displays the Name as set in the **Protocol List**.

- Number of inputs used** Click on the up or down arrow or in the field to select the inputs required.

- Bit D0 – D7 – Input** Click in the **Input** field to assign the input to a data bit.

- Analog Threshold** Click in the field to set the threshold value.

- Copy to Notes** Click the button to toggle the switch to copy the results to notes.

21.5 Using the Protocol Decoder

The protocol decoder decodes SPI, I²C, RS232/422/485 serial data (UART), and a count-based decoder is provided.

Notes:

All 4 decoders can be used at any one time.

Each decoder outputs to one line on the **Digital Inputs**.

Decoded symbols are positioned starting at the first bit of the decoded symbol if the graph time base allows. If the time base is zoomed out, decoded symbols are compressed together.

Each decoder can be assigned a name.

If the decoded output is displayed as characters, non-printing characters are displayed as '.'.

Newlines are output correctly.

Initial Setup

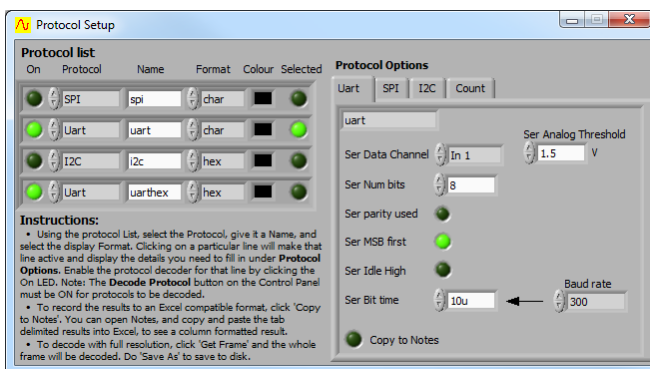

Configure the number of bits, data sense, bit order, chip select active level, and the source for each decoder input.

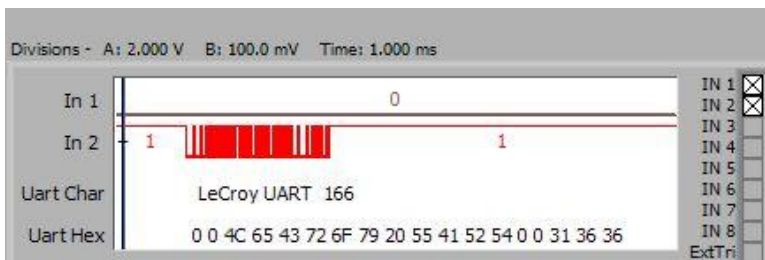

Select any Cleverscope input signal (In1-8, Chan A, Chan B, and Ext Trig) as a source.

Configure threshold level for analog sources.

Choose display colours for the symbols.

Select how decoder results will be displayed - Characters, Decimal numeric or Hexadecimal numeric.

Select **Copy to Notes** to automatically copy decoded results to the **Notes** display. Use this feature to capture strings and then copy and paste into other applications.

Decoded symbols are compressed to a single string, if the inter character time is less than three character durations.

Each decoded string includes the time at which it occurred, with 10ns resolution.

Using **Notes** and an Excel spread sheet, it is easy to measure the time between messages.

21.6 Using the Protocol Decoder - Additional Notes

The I²C decoder uses colour highlighting to show the address, data, start, stop, ack, and fault/non fault status.

The protocol decoder works over both regular captures (automatically improving sample resolution if required), and over full buffer transfers. A full buffer (4M) capture of 2 seconds will have 500ns resolution, still sufficient to decode 400 kHz I²C, 115 kbaud serial, and 500 kHz SPI. 2 seconds of transfer represents a message of about 100,000 I²C characters, 23,000 serial characters or 125,000 SPI characters if transmitted at full rate.

Decoded messages are automatically saved in the .apc file when saved, allowing the captured signal and decoded message to be viewed using the Cleverscope application – useful for sharing via a network, email or later review.

If the display width chosen on the **Scope Display** results in a resolution that doesn't show the individual bits of the signal then the protocol cannot be decoded or displayed. However, clicking **Get Frame** should be able to decode it because the data will be brought in at a higher resolution.

In addition the decoders work on a frame by frame basis. The current frame is set using **Current Frame** on the **Cleverscope Control Panel**. Changing the current frame allows reliable navigation and display of each frame contents.

If the protocol decoder is enabled, as each new frame is displayed for the first time, the frame is decoded, and optionally added to the **Notes**. This capability means that multiple short messages can be captured and displayed and decoded, without capturing the intervening dead space.

For example to record the first 50 messages being sent, set the number of frames to at least 51, and the number of frames per capture to 50. (Use **Acquisition Settings** on the **Settings** menu). Click **Single** (assuming you have set up the trigger beforehand), and the next 50 messages will be captured.

You can now use **Current Frame** to navigate each message. As the frame is loaded, it is decoded, and the message added to **Notes**, if **Copy to Notes** is enabled. Inter message time can be as short as 20us.

21.7 I²C protocol Example

Cleverscope's built-in I²C protocol analyser simplifies signal stream analysis of the two-wire multi-master bus typically used to communicate between peripherals and embedded devices

Setting up the I²C protocol analyser

The setup screen shows the I²C decode selected in the **Protocol List** and the settings on the **Protocol Options** tab as below:

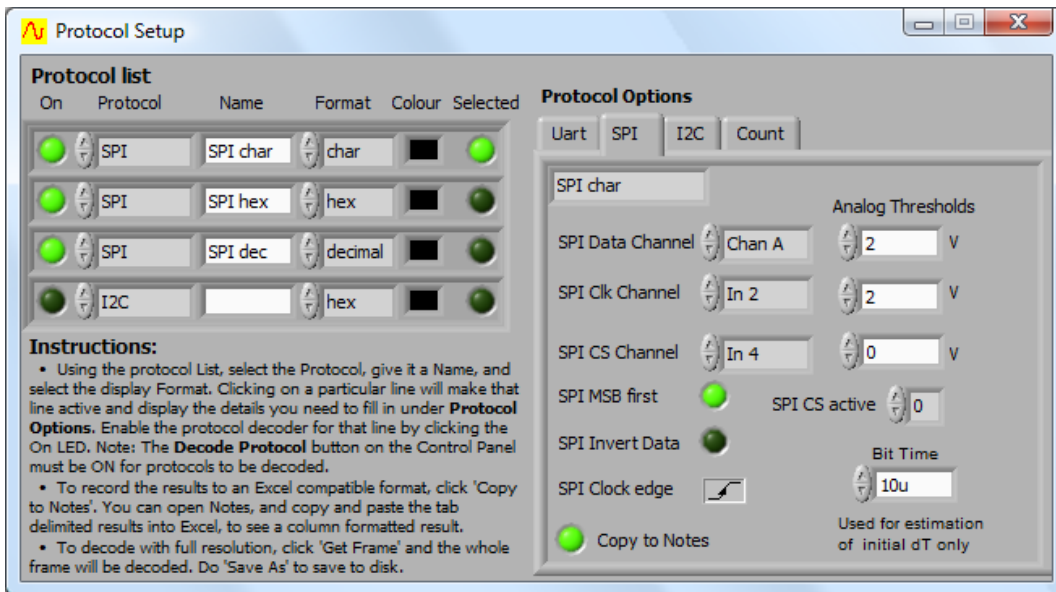

I²C protocol analyser output

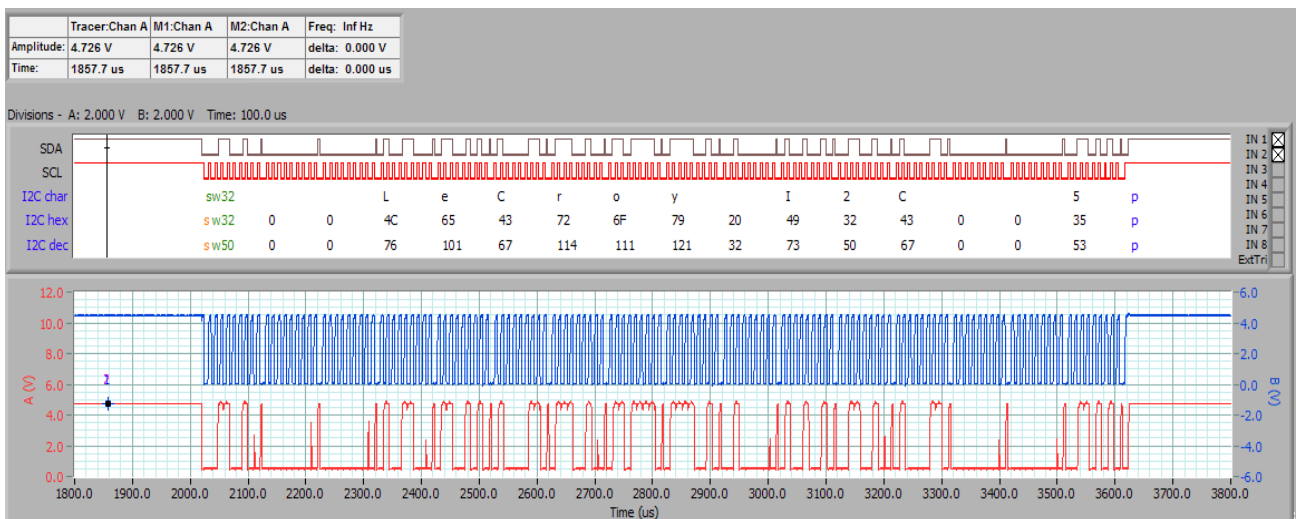

The Scope display shows the colour coded I²C decode

If there is room, the symbol is positioned at the correct time position on the signal. Values can be displayed in character, hex and decimal. The address (shown in green) is always displayed in hex or decimal. The start condition is denoted with an orange 's'.

The stop is shown with a blue 'p'.

A repeated start is shown as sR.

Acks are not shown.

Nacks are shown as a red 'k'.

Extended addressing is supported, displayed as yellow extended address values.

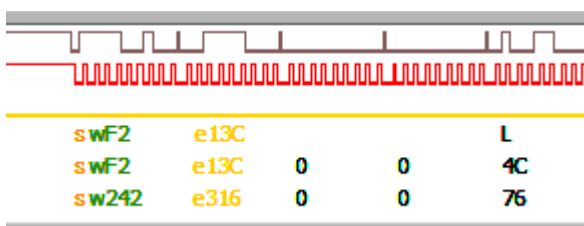

Note: You can zoom on any symbol in display
 If there is insufficient room symbols are concatenated:

In this example the second message was extended, had repeated starts, and ended with a Nack. The whole message is shown in red as a result. Zooming in shows the individual symbol colours and positions

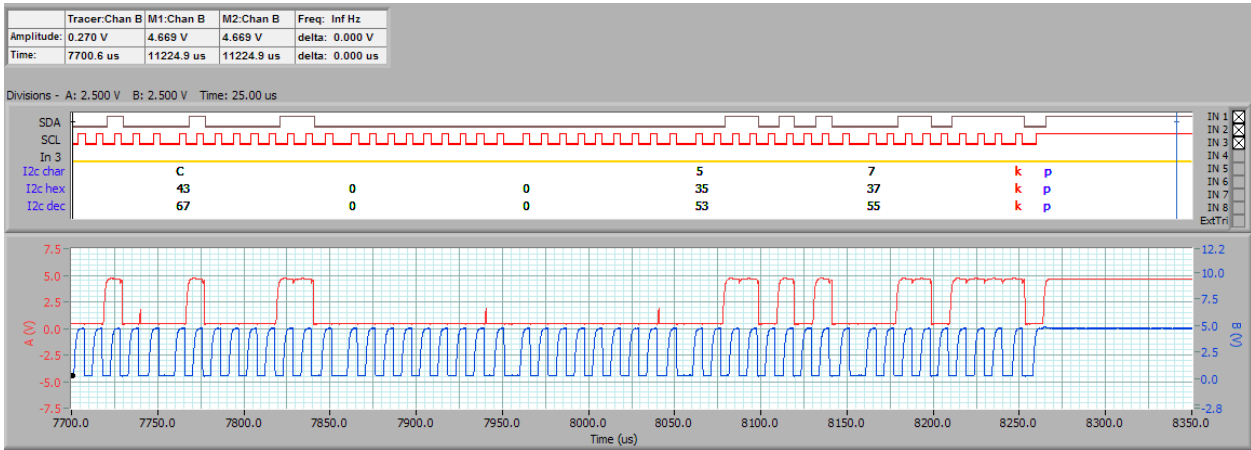

21.8 UART Protocol Example

The source for each data line can be any one of the Digital Inputs 1-8, the external trigger, or Channel A or B. If Channel A or B is used you can set the threshold (or where there are two or more inputs, the threshold for each one of them). The UART decoder function allows you to choose the number of bits if parity is used, the bit order, and the idle state, in addition to the bit time. A calculator for pre-setting the bit time with standard Baud rates is included. Otherwise you can just type in the time (as we below – 10usecs).

Setting up the UART protocol analyser

The setup screen shows the UART selected in the **Protocol List** and the settings on the **Protocol Options** tab as below

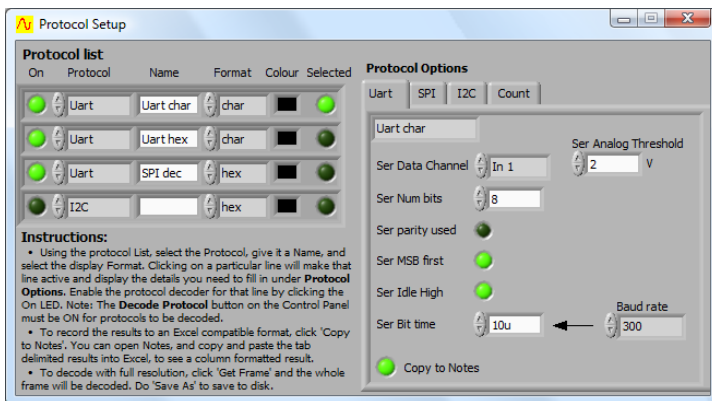

UART protocol analyser output

Here is the **Scope Display** displaying the UART message.

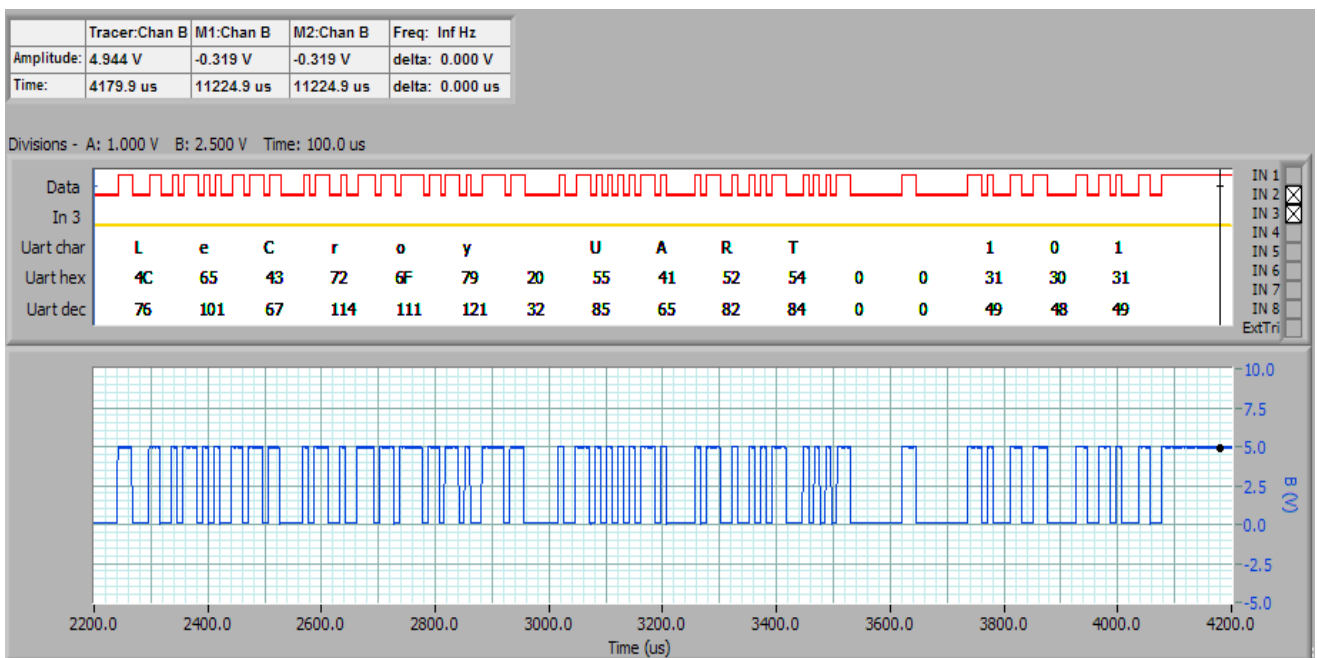

21.9 SPI Protocol Example

Setting up the SPI protocol analyser

The protocol setup below shows Channel A used as the SPI Data Channel source:

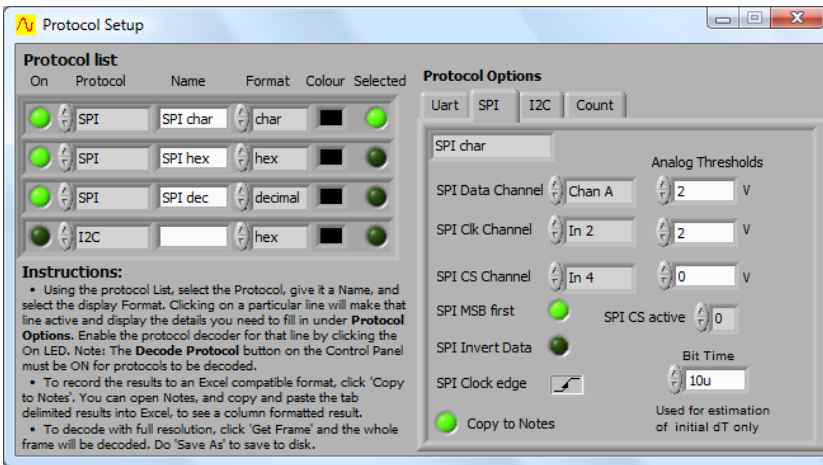

Note: As an analog channel was used the signal threshold was at the given Analog Threshold (2V).

Watch a demonstration of SPI protocol decoding here www.youtube.com/watch?v=J5sZoDcagJM.

SPI protocol analyser output

The Scope display shows the colour coded SPI decode.

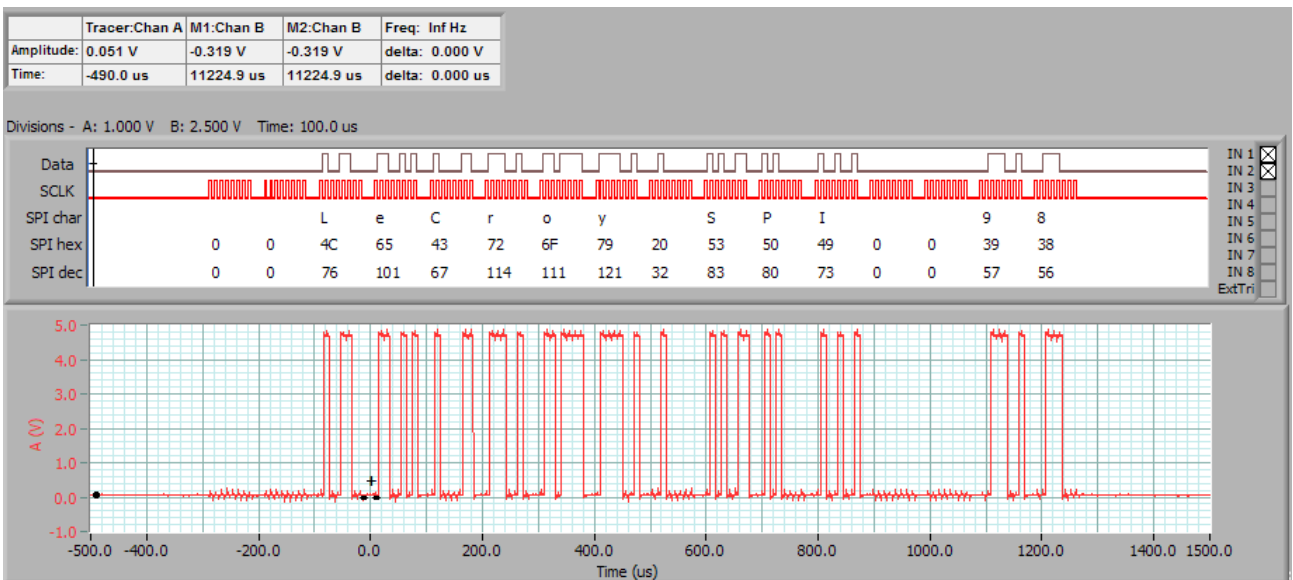

Note: The data line has been connected to both Input 1 and also Channel A.

22 Notes [View Menu]

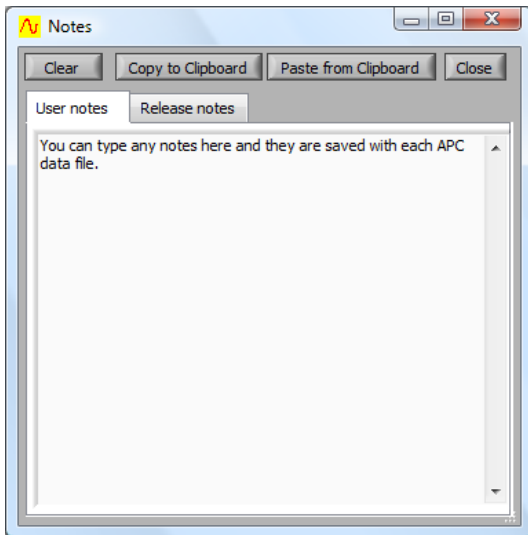

Notes can be added and displayed to accompany any set of data readings in the **Notes** window.

Any notes you enter on the **User notes** tab are saved with each APC data file.

If you click the **Send to Notes** LED on the **Protocol** display any decoded protocol messages will be automatically added to notes.

Cleverscope application update release notes are displayed on the **Release notes** tab.

| | A | B | C | D | E | F | G | H | I | J | K | L |
|----|-----------------|----------|-------------------------|---------|---|---|---|---|-------------|------------|--------------------|---|
| 1 | | | | | | | | | | | | |
| 2 | | | | | | | | | | | | |
| 3 | Name: Uart char | Frame: 2 | Trigger time: 20-Feb-09 | 21:46 : | | | | | 59.2283041 | | | |
| 4 | | | | | | | | | | -3.09E-06 | ..LeCroy UART..74 | |
| 5 | | | | | | | | | | 0.04367691 | ..LeCroy UART..75 | |
| 6 | | | | | | | | | | 0.08736315 | ..LeCroy UART..76 | |
| 7 | Name: Uart char | Frame: 2 | Trigger time: 20-Feb-09 | 21:47 : | | | | | 49.50760459 | | | |
| 8 | | | | | | | | | | -4.29E-06 | ..LeCroy UART..201 | |
| 9 | | | | | | | | | | 0.04367739 | ..LeCroy UART..202 | |
| 10 | | | | | | | | | | 0.08735907 | ..LeCroy UART..203 | |
| 11 | Name: Uart char | Frame: 2 | Trigger time: 20-Feb-09 | 21:48 : | | | | | 2.306724927 | | | |
| 12 | | | | | | | | | | -4.29E-06 | ..LeCroy UART..238 | |
| 13 | | | | | | | | | | 0.04367955 | ..LeCroy UART..239 | |
| 14 | | | | | | | | | | 0.08735691 | ..LeCroy UART..240 | |
| 15 | | | | | | | | | | | | |
| 16 | | | | | | | | | | | | |
| 17 | | | | | | | | | | | | |

The 'copy' includes tab characters, so that the columns line up well.

Watch a demonstration of protocol decoding here www.youtube.com/watch?v=J5sZoDcagJM.

23 Using the Ethernet Cleverscope

The Ethernet Cleverscope can be connected to a 10/100 Mbit/sec Ethernet network via an Ethernet connector that automatically senses the speed (10 or 100 Mbit/sec) and automatically reverses Tx and Rx if the Ethernet cable has been crossed over.

No cross-over cable is required for connecting a Cleverscope to a PC Ethernet port.

The Cleverscope can be operated with either a Fixed IP address or as part of a DHCP network (Dynamic Host Configuration Protocol), in which case it will automatically acquire an address in the correct internet protocol address range.

The simplest use is as part of a DHCP network. Most modern routers and all servers offer a DHCP server function.

You can also use Fixed IP (Internet Protocol) Addressing, which is useful when you do not have a DHCP server, or are connecting to a remote Cleverscope connected at some other location.

This section provides instructions on using the Cleverscope as part of a DHCP network, or in a fixed IP address network.

23.1 Using Cleverscope on a DHCP Network

The Cleverscope is set by default to work as part of a DHCP network. When it is plugged into a network, the two lights on the Ethernet connector show status.

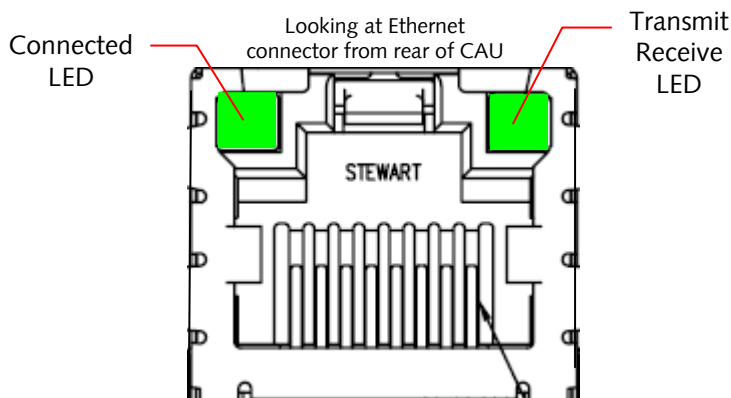

The **Connected LED** shows that the Cleverscope has connected to the network. The **Transmit/Receive LED** will flash whenever packets of data are transferred. Once the Cleverscope has triggered, the **Transmit/Receive LED** will flash once per second, as the Cleverscope application polls the Cleverscope to make sure it is still connected.

If the **Connected LED** is not on, there is a problem, and the Cleverscope will not talk to the Cleverscope application. Please resolve the connection first.

To use the Cleverscope carry out these steps:

Connect the Cleverscope to the network and turn it on. Make sure the **Connected LED** comes on.

On the **Settings** menu click **Choose Acquirer and set connection** to display the following dialog:

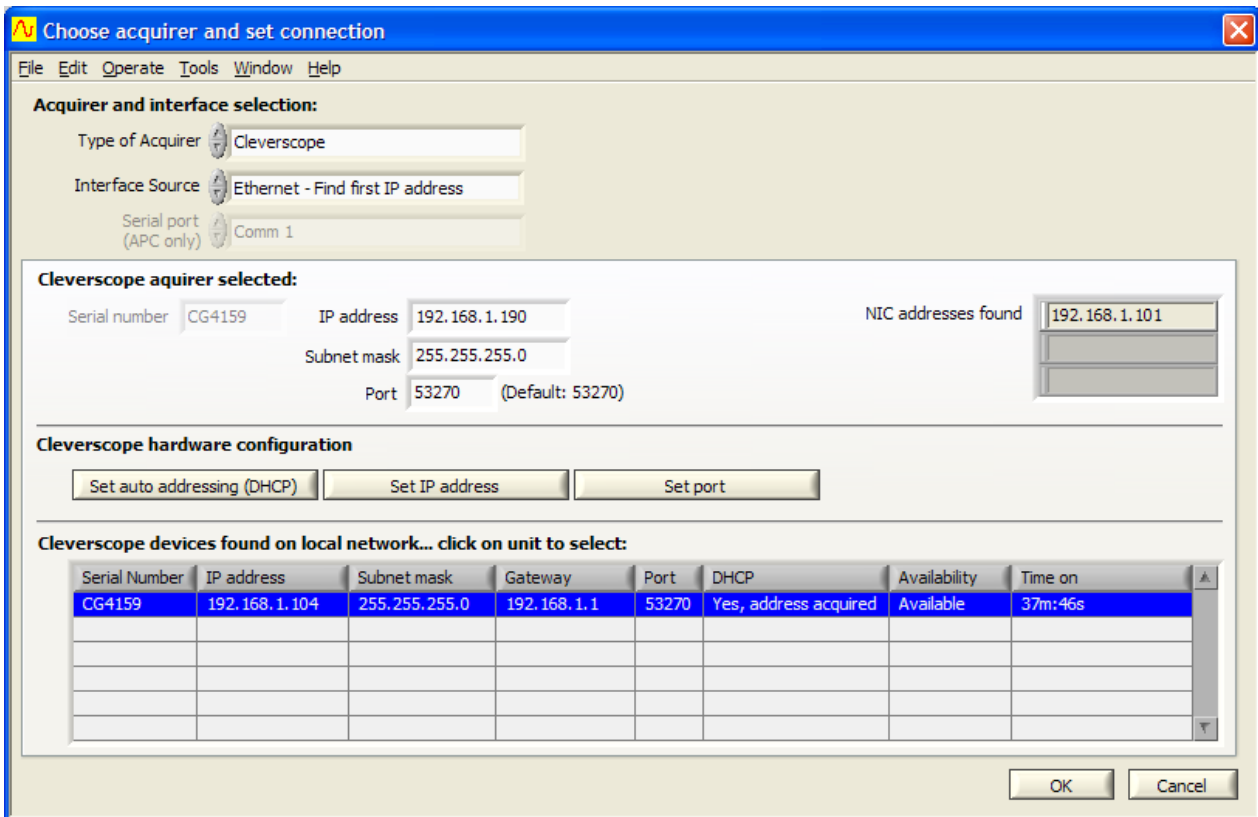

Make sure the **Type of Acquirer** is *Cleverscope*. Set **Interface Source** to *Ethernet – Find first IP address*. This option will find the first free Cleverscope available on the network.

You should see the Cleverscope listed under **Cleverscope devices found**. If the entry under **DHCP** is not *Yes, address acquired*, select the line which corresponds to the Cleverscope you want to use, and then click **Set auto addressing (DHCP)**. This will cause that Cleverscope to use the DHCP method of addressing. The **DHCP** column should change to *Yes, address acquired*, after you have clicked the button.

Click **OK**. The Cleverscope should be ready for use – click **Auto** on the **Cleverscope Control Panel** to acquire a signal.

The next time you start up the Cleverscope, and run the Cleverscope application, you do not need to do setup – the Cleverscope will automatically connect.

23.1.1 Connect by IP Address

The Cleverscope application can also connect to a particular Cleverscope by IP address. DHCP is still being used to bring the Cleverscope on to the current network. DHCP has a 'lease time' which is usually quite a long time (weeks). Each time the Cleverscope is reconnected to the network, the lease is renewed. The lease is for a set IP (Internet Protocol) address that is supplied by the DHCP server. This means once you use the Cleverscope on a network, you can use its address to reliably connect to just that Cleverscope.

To do this:

Set **Interface Source** to Ethernet – Find by IP address.

Select the unit you want to use under Cleverscope devices found, this will update Cleverscope acquirer selected to have the same IP address as the one you selected.

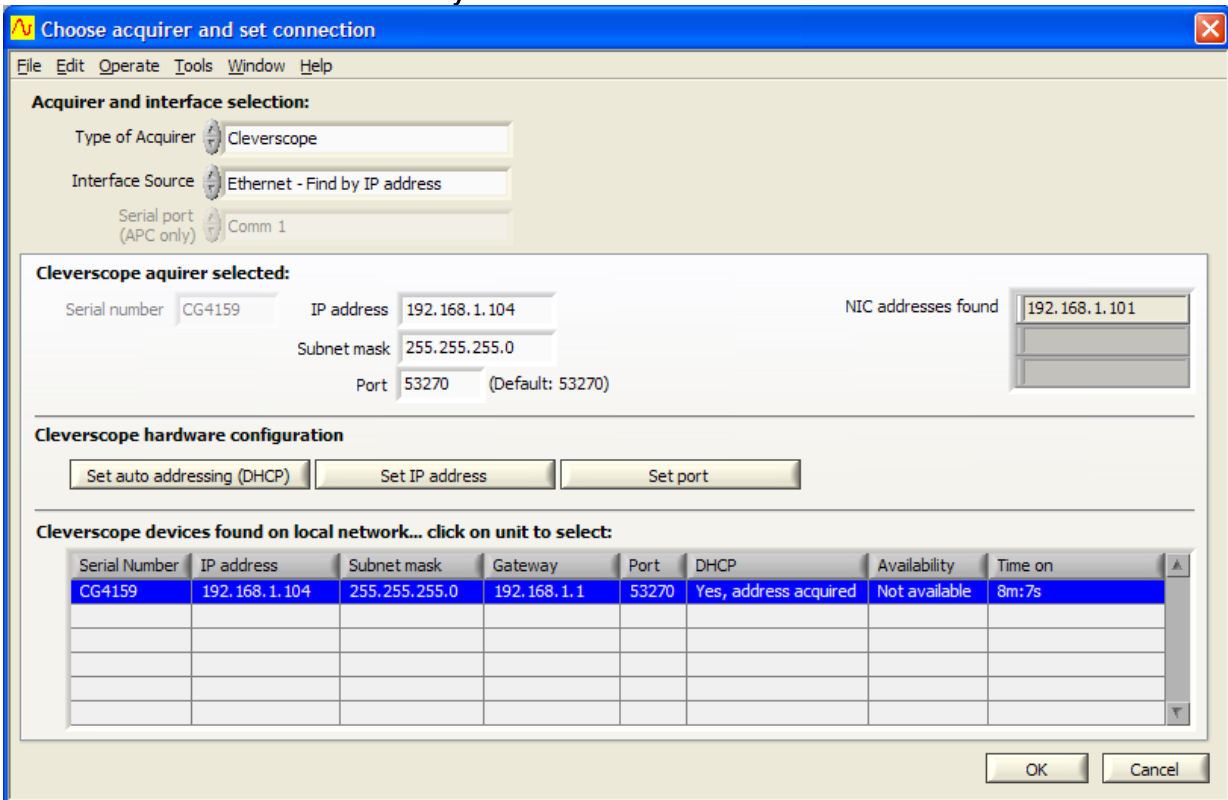

Notice that Cleverscope acquirer selected has an IP address of .104. This is the same as the device selected from the list.

Click **OK**. From now on, the Cleverscope application will always connect to the Cleverscope with an address of .104. Other Cleverscopes will be given different addresses by the DHCP server.

23.1.2 Connect by Serial Number

The Cleverscope application can be setup to always connect to a given serial number, regardless of the IP address. Setup as follows:

Set **Interface Source** to Ethernet – Find by Serial Number.

Select the unit you want to use under Cleverscope devices found, this will update Cleverscope acquirer selected to have the same Serial number as the one you selected.

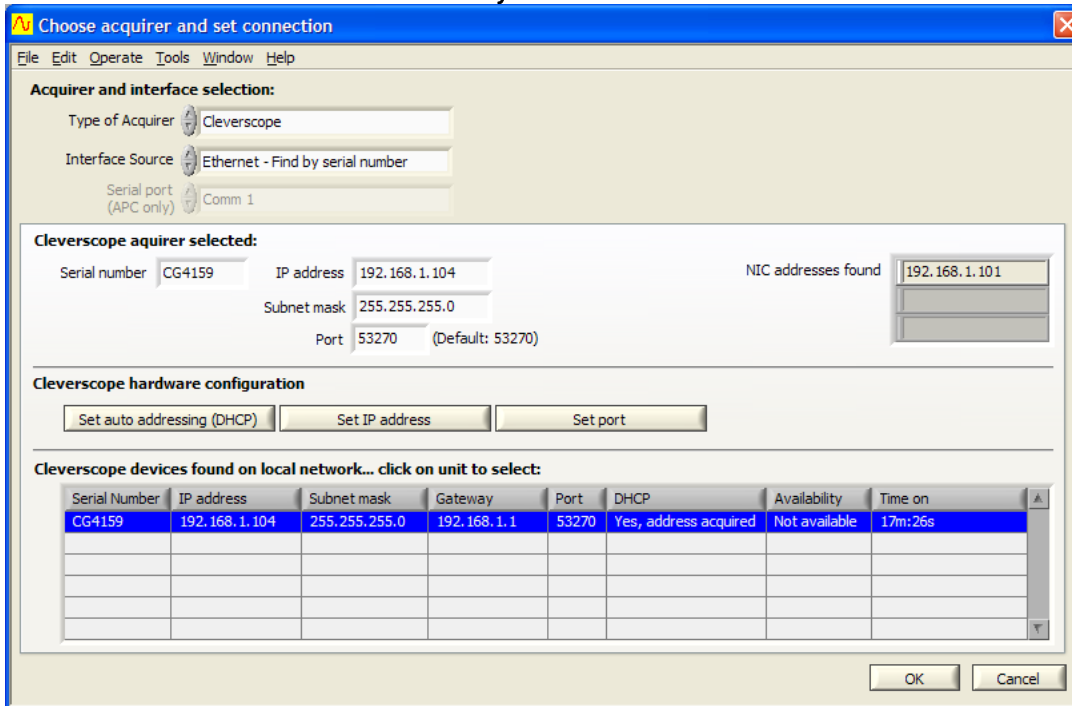

Click **OK**. The next time you start the Cleverscope application, it will connect to the given serial number, regardless of IP address.

23.2 Using Cleverscope on a Fixed IP Network or Direct Connected to a PC

For a fixed IP network, for example a Cleverscope plugged directly into a laptop, you need to do a little more work. We will examine two situations: the Cleverscope is plugged into a fixed IP local network; the Cleverscope application is connecting to a remote Cleverscope at some other place.

For this network there is no DHCP server, and so someone will need to manually enter the IP address of each unit on the network. All the units must be on the same 'subnet'. All units, and the PC must have different unit ID's.

The IP protocol subnet is the first three groups of digits in the IP address. For example, for 192.168.1.104, the subnet is 192.168.1. The unit IDs are the last digit, eg 104 and 1. These must be different for all units in the local network.

So let us look at an example of a Laptop and a Cleverscope connected directly to each other with an Ethernet cable (because of the Auto direction, it is not important if the cable is cross over or not).

The examples that follow are from Windows XP. The setup is similar in other operating systems.

1 Click Start, then Settings, then Control Panel. Open Network Connections

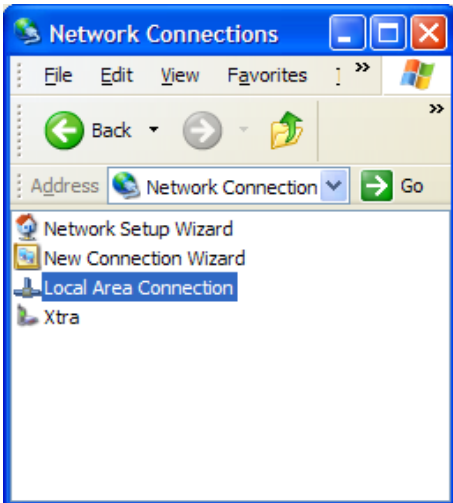

2 Open Local Area Connection, and click Properties

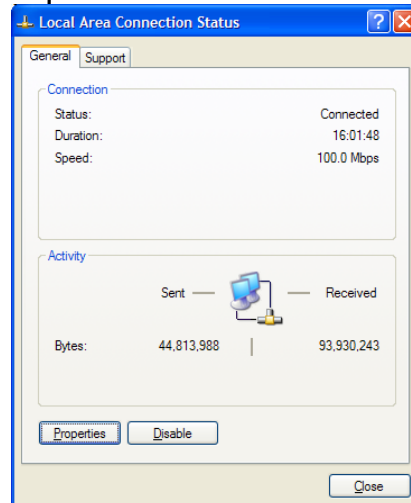

3 Scroll down until you see Internet Protocol (TCP/IP)

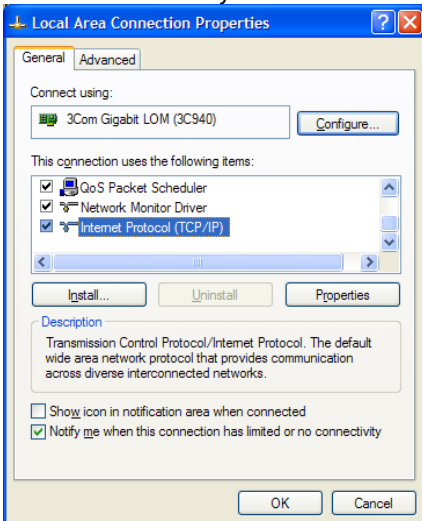

4 Double click on Internet Protocol (TCP/IP)

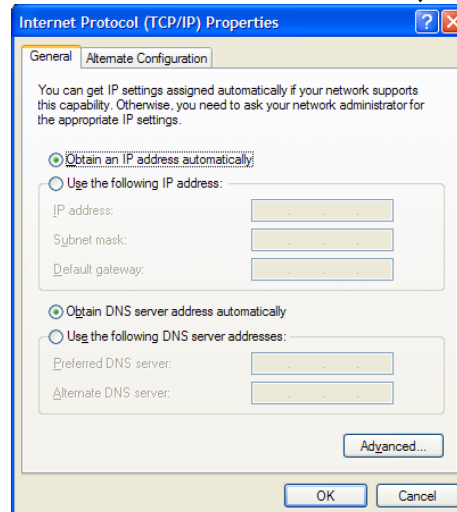

5 Now set the computer to use a fixed address (not get the IP address automatically):

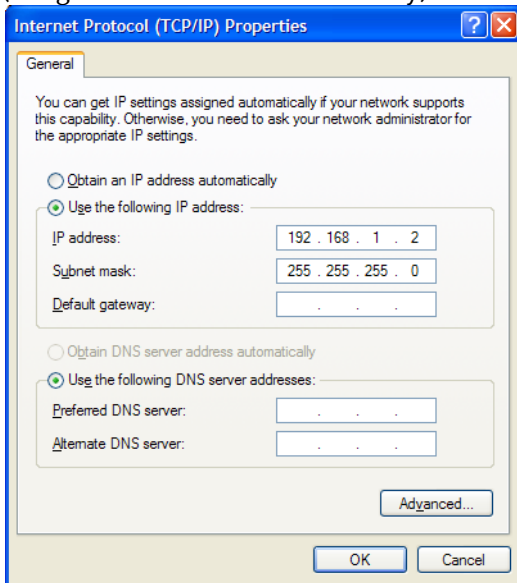

Click **Use the following IP address**, and type in the **IP Address** that you want to use

Enter a **Subnet mask** that encompasses all units on your subnet.

Use values shown in the picture if you are not sure:
e.g. IP Address 192.168.1.2 and
Subnet mask 255.255.255.0

Click **OK**, and close all the dialog windows.

Open the Cleverscope application:

On the Settings menu, click Choose Acquirer and set connection.

Connect the Cleverscope to the Laptop, and power up.

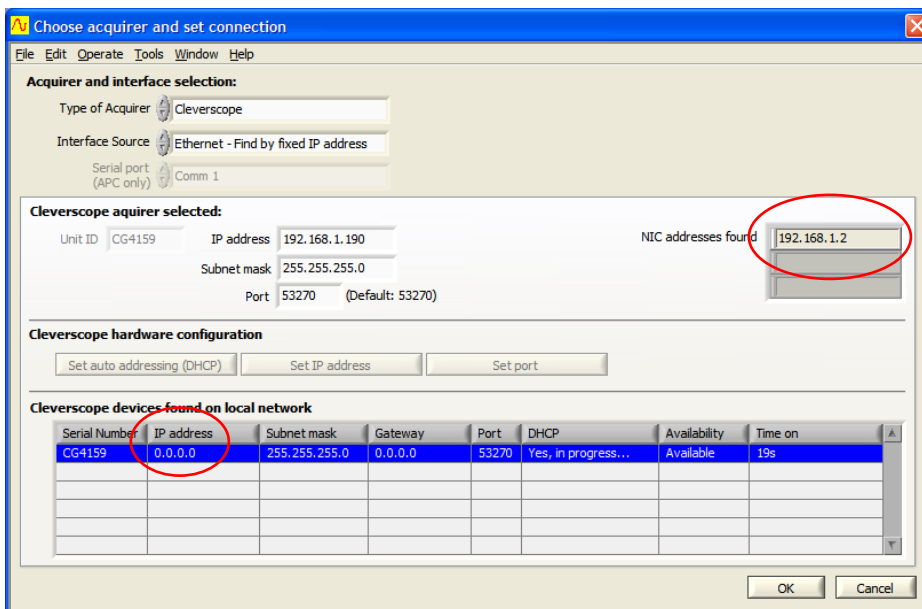

If the Cleverscope was setup for DHCP, it will **not** find an address, and you need to set it manually, so follow the instructions below. You can tell that the Cleverscope was set for DHCP because the Cleverscope IP address is returned as 0.0.0.0 as there is no DHCP server.

First click on the Cleverscope to connect to (even if there is only one), to select it - the line will become blue - type the fixed IP address you want to give the Cleverscope into the **IP address** field in the **Cleverscope acquirer selected** panel, and click the **Set IP address** button. In the example above we used 192.168.1.190 - it needs to be different from the NIC address in the last digit.

Note the Cleverscope DHCP column changes from *Yes, in progress* to *No, using static IP* as in the picture above.

Once you see that the address of the Cleverscope has changed to what you programmed it to, we suggest you power it down, and then up again – just to verify that the address and static IP usage are correct. Remember that the subnet (the first three numbers of the IP address) must be the same for the Cleverscope and the NIC address found (which is the PC's address).

Click **OK**, and then click **Auto** on the **Cleverscope Control Panel** to acquire a signal.

Now you must make sure that the first three digits of the IP address match the first 3 digits of the PC **NIC (Network Interface Card) addresses found**, which in the example above is 192.168.1.2. The last digit must be different. This is known as being on the same subnet. If the first three digits don't match, the Cleverscope cannot communicate. Make sure the subnet (the 192.168.1 part) are the same and the unit ID's (190 and 2) are different.

23.2.1 What if things don't work?

Here are some issues we've had in the past that may help in getting things going:

1. You cannot set the Cleverscope IP address.
This might happen if you have IPv6 enabled and the Cleverscope is set for DHCP. Temporarily turn off IPv6, set the Cleverscope IP address, and then turn IPv6 back on again. In Win 7 Start/Control Panel/ Network and Sharing Centre/Change Adapter Settings/Local Area Connection/Properties and unclick Internet Protocol Version 6, then ok.
In Windows 8, Search for Control Panel, go to the *Control Panel*, choose *Network and Sharing Centre*, then *Change Adaptor Settings*, then double click on *Ethernet*.
2. Sometimes if you have a WiFi adaptor, it can take precedence over the wired Ethernet adaptor. Disable it while making the connection, and then re-enable.

23.3 Remote Fixed IP Network

In this situation, you do not have a Cleverscope – it is located somewhere else, and you want to connect to it over the internet. Your IT people will make a bridge from the Cleverscope to a port on the internet connection point, and give you the address. In this example the address is 60.234.234.7.

On the Settings menu, click Choose Acquirer and set connection.

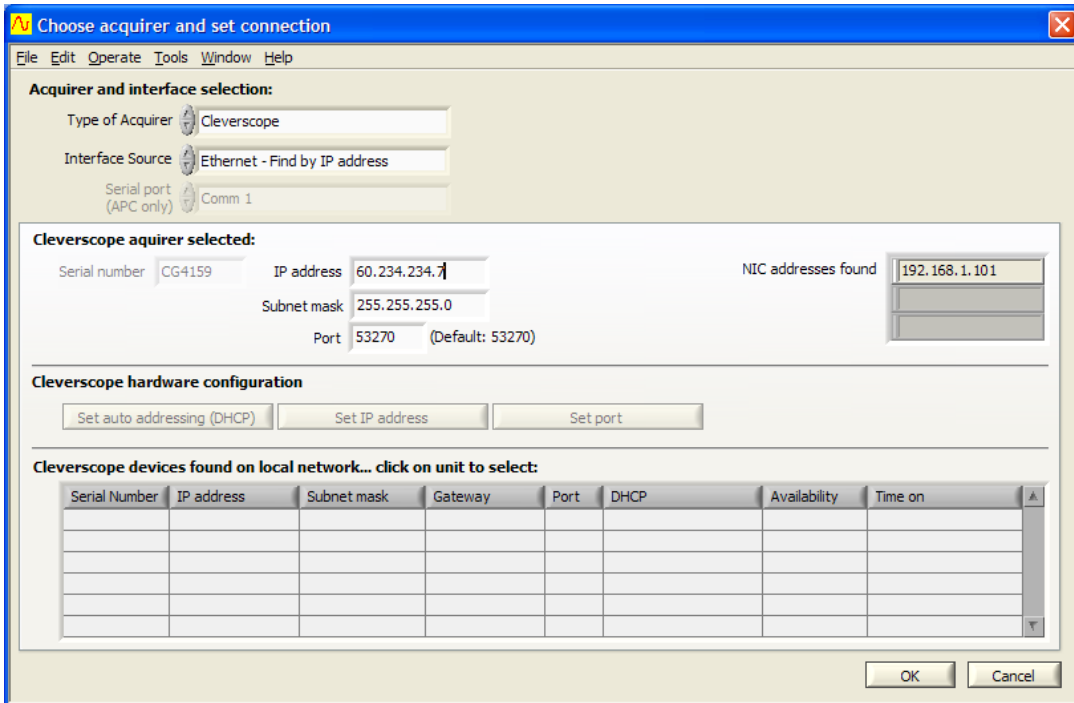

Set **Interface Source** to Ethernet – Find by IP address.

Enter the **IP address**.

Click **OK**, and then click **Auto** on the **Cleverscope Control Panel** to acquire a signal from the remote Cleverscope.

One way to obtain a remote IP address is to use a dynamic DNS service such as <http://dyn.com/dns/>. You will need to make sure the ports 53270- 53272 are open to cleverscope.exe in your local firewall.

24 4-Channel Cleverscope

The 4 channel scope setup uses two CS328 Cleverscope Acquisition Units (CAU), a CS022 link cable, and the 4 channel scope software, cleverscope4.exe.

Each CAU needs to be setup with a different USB Serial Number. You can use the program Mprog 2.3 to do this. It's best if the CAU's are powered up, connected and linked before running the Cleverscope application.

24.1 Binary Version

Both CAU's must be programmed with version cscope_pld v3425.bin or later. Please use the ROM loader to update the CAU's. See the instruction on upgrading the hardware that came with your installation disk (which is also where you will find the ROM loader – copy ROM Loader.exe to your program files\cleverscope directory to use it). You will find cscope_pld v3425.bin on the <http://www.cleverscope.com/resource/> page.

24.2 USB Serial Numbers

Each CAU needs a separate USB Serial Number. The utility Mprog 2.3 can set the address. You can find out what the USB serial number is by running the standard Cleverscope application, acquiring a signal, and then using Help/About. The USB Serial Number is of the form CS328A01, 02, 03..

The Cleverscope4 application automatically orders units in order of serial numbers. The lowest serial number becomes unit 1. The next higher serial number becomes unit 2 and so on.

If the USB serial numbers are all the same for the CAU's you must program one of the CAU USB serial numbers to be different. First put aside a CAU with the serial number CS328A01. Label it Unit 1. Take the other unit, and label it Unit 2. You will need to program Unit 2 as explained next:

24.3 Program USB Serial Number

Connect only **one** CAU. (If you have multiple CAU's attached they will all be programmed with the same serial number!). It is recommended that other USB devices such as USB to serial converters also be disconnected (in case they use the same FTDI device as the CAU uses, in which case they will also be programmed).

Download MProg230_Setup.zip from <http://www.cleverscope.com/resource/>, and unzip into a folder of your choice. Run MProg_Setup.exe.

After installation run Mprog 2.3 and use File/Open, and navigate to the folder where you unzipped the files.

Open Cleverscope CS328 Unit 2.ept. You will see the following screen:

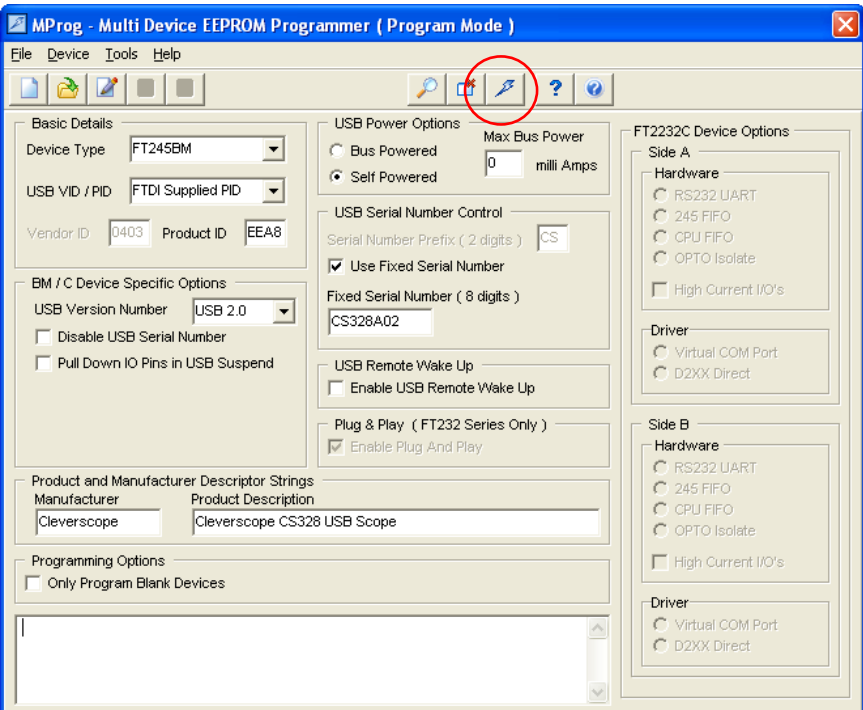

Do not change any values

Click on the  button.

This will program the Unit 2 CAU with the serial number CS328A02.

Cycle the power on the CAU to register the new serial number.

24.4 Connect the Units

It's useful to place the CAU's on top of each other. Connect the CS022 link cable between the two units. Plug into the Link socket, and make sure the line on the plastic housing is uppermost for both plugs.

Connect each unit to the computer using a USB cable. You should hear the computer ding as you plug in each unit. [If you want, you can copy the program Files/cleverscope directory to a new directory such as program files/cleverscope_dual. If you do this you can run two copies of the Cleverscope application (one from the original cleverscope directory, and the other from the cleverscope dual directory), and each one will pick the next higher available USB serial number to work with. In this way you can run both CAU's at the same time to make sure they work properly, or have two independent scopes running).

Connect some signal sources, and you are nearly ready to go.

24.5 Ready the Cleverscope4 Application

Go to <http://www.cleverscope.com/resource/> and download Cleverscope4.zip into your 'program files\cleverscope' directory. Unzip into the same directory. You may make a short cut to cleverscope4.exe and put it onto the desktop (we do offer an installer, but if you do it this way you only have to download a 3.7 Mbytes!).

24.6 Run the Cleverscope4 Application

Double click on your Cleverscope 4 shortcut icon as normal. The 4 channel version should power up. Here is a screen shot:

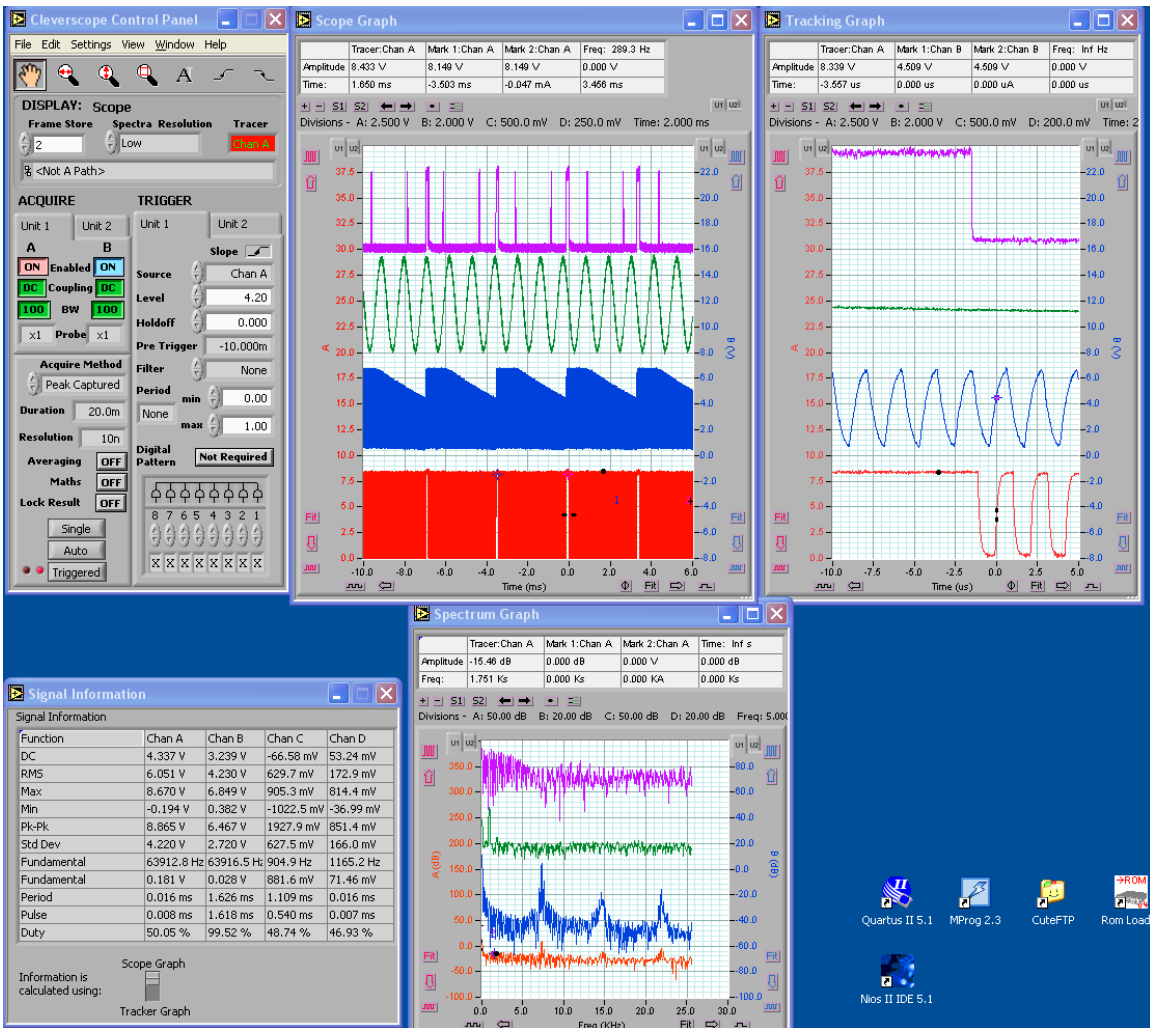

You will see that the control panel and graphs have tabs for both units. We've done it this way to make a one-to-one correspondence with the physical units. You can turn on or off channels, and select coupling and BW on the Acquire Panel. You can select which unit triggers (only one unit can trigger at a time) by selecting the trigger tab, and on the tab you can select which channel triggers, and the trigger spec as normal.

On a graph you can select which channel the axis refers to. On the left you have Channel A for unit 1 and 2, on the right you have Channel B for unit 1 and 2. If you click on a graph, and use the Tab key, you can quickly move from channel to channel, and the application will automatically show the correct axis.

In the information area the channels are called A, B, C and D. This can be a little confusing and we are work out ways to make it clear.

You should find that most dialogs have tabs for the two units, and you can choose the appropriate unit to make changes for.

The version of Cleverscope that formed the base for Cleverscope 4 is now quite old. We anticipate getting the application up to the latest standard quite soon. There are still some defects in the application, and these will be fixed.

Some defects:

1. You cannot use the trigger cursors to set the trigger for Unit 2 (Channels C and D). You will need to type in the trigger level directly.
2. If you run the application with only one acquisition unit connected, it will turn off the other two channels, and they won't be used. However the tabs will stay visible. After exiting, you might connect the other unit. When you start up the Cleverscope4 application, and run an acquisition, it will see that last time there were only two channels, and will not display the tabs, even though there are 4 channels. You need to exit the application and the start it again. The tabs for both units will be present; however the channels for unit 2 will be disabled. On the acquire tab, click Unit 2, and then enable both channels (if you want them).
3. There are still some situations where things get confused. We have to work on this. The easiest way out is to quit the application, cycle the power on both units, and start again.

All the same, it seems to be working well enough to demonstrate the concept. We will be improving it.

25 Updating Cleverscope

This section shows how to update the **Cleverscope** application using the **Cscope Update 46xx** download from the **Downloads** section on our website and how to update the firmware inside a *Cleverscope Acquisition Unit*.

25.1 Important – Read Before Starting

ROM Loader

The **ROM Loader** has changed. Please use **ONLY** ROM Loader **6.0** or later, as included with the update.

This **ROM Loader** loads each model of the *Cleverscope Acquisition Unit* (CS328 Classic, CS328A USB and Ethernet varieties). It also uses a unified file that contains all the version information required.

The format of this file is: cscope_fw 64xx 53xx.cmf

Update to Calibration Table

We have updated the calibration tables for **Cleverscope** application versions 6442 and later.

If you have been using 6441 and earlier, you will need to do a *Once Yearly* calibration followed by *Standard* calibration. For instructions see section **26 Calibrate Cleverscope (versions 6442+)**.

25.2 Cleverscope Application Software First Time Installation

If you are installing **Cleverscope** for the first time on a new PC, you can get the latest installation from the **Downloads** page of the website at www.cleverscope.com/resources/. Look for **Complete Installation**.

Note Cleverscope no longer supports Win98. If you need a Win98 version, please look at the **Downloads** page (www.cleverscope.com/resources/) for the last version available.

Please carry out the following steps:

Follow the instructions in section **25.5 Update an existing Cleverscope Application** only instead of downloading the **Software Update**, download the **Complete Installation**.

Connect up the *Cleverscope Acquisition Unit* – connect the USB cable to a spare port on the PC and plug in the power adaptor.

The PC should discover the USB connection and display *Cleverscope CS328A MSO* or similar. Just wait after this for Windows to load the driver request dialog (it might take some seconds as some installations go looking on the internet for a driver).

Once the dialog comes up, choose to find the driver automatically. Windows will find the driver and install it. After a short time Windows should announce that the hardware is installed. For Windows Vista and above this process should happen automatically.

Start-up **Cleverscope** (it will be in the **Start Orb, All Programs**. You can drag it to the desktop if desired).

In the **Cleverscope Control Panel**, click **Auto**, and the graph should become live.

Now follow section [Compensate Probes](#) in Getting Started to set up the probes.

25.3 Updating Cleverscope

Note This section only covers the updater, which assumes you already have an install on your PC. See previous

section [Cleverscope Application Software First Time Installation](#) if you want to install for the first time.

If you have un-installed **Cleverscope** using the Windows un-install process, you will need to do a full install. The updater will not work.

To Start

If the **Cleverscope** application is already installed, use **Auto** to acquire a signal (which gets the CS328A *Cleverscope Acquisition Unit (Cleverscope)* information into the PC memory), and then use the menu **Help/About Cleverscope** to get the **App Version** number and **Firmware Version** number. Record these for use below.

If the **App Version** number starts with 3.2 or 3.3 please see the section **25.10 Update a First Generation Installation** below before starting.

App Version
4.664

Note If you are using application 4.624 or earlier, we have updated the USB drivers to use National Instruments NI-VISA® drivers. If you do not have the Visa run-time installed, you will need to install it. The installation update program (see the next section) will do this for you.

Firmware Version
6459

25.4 Important – Before Updating

After verifying the version numbers, you decide to update the **Cleverscope** application, please turn **off** the *Cleverscope Acquisition Unit*. This will ensure that drivers are correctly pre-loaded.

25.5 Update an existing Cleverscope Application

You may download a copy of the latest Cleverscope application software from the **Downloads** page of the Cleverscope website at www.cleverscope.com. The following explanation is for **Windows 7**. The process will vary slightly for other operating systems.

Visit the www.cleverscope.com site, and then go to the **Downloads** page shown below.

cleverscope plug & play instruments

Home About Us Products Testimonials Forum Videos Downloads Distributors Contact Us

Most files are zipped and you will need to unzip them. In the case of applications and patches, run 'setup.exe' to install. Can not find what you want here? Join our forum and ask the question. Other users may well have an answer for you. A short list of resources available to you. Click on one to go directly to it or scroll down and read about all of them.

Software Documents Drivers

Software Update
Complete Installation
Win 98 Update
Win98 PI-II Install
Cscope 4 Channel

Software Update
08 May 2012 - 29.8 MB Download

The latest version number is v4.664, dated 8 May 2012. ALWAYS read the [Cleverscope Update Instructions](#) pdf included in the update file before starting.
4.664 Changes the Tracer and Marker Cursor list. Includes fixed vertical and horizontal options. Use the Control Panel Cross Hair button to move them. NOTE: Update the firmware using the Rom Loader (see Start/Cleverscope/Rom Loader) to 6456 or later to use this update. A complete history of the software is available [here](#)

Complete Installation
29 Mar 2012 - 40.8 MB Download

Full Installer for Win XP, Vista and Win 7 x32 and x64. Provides a complete install of v4.662. Works with both CS328 and CS328A. Only required if you mistay the original CD and have to re-install. To update an existing installation, use the software update file. Extract folder in zip to your hard drive and run setup.exe

If **Cleverscope** is already installed, click **Software Update** to download the latest update. Always use update if **Cleverscope** is already installed. This file is considerably smaller than a full install. Otherwise click **Complete**

Installation to download the full installer.

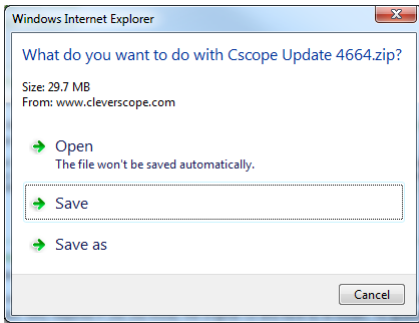

Choose the option of saving the zip file rather than opening it.

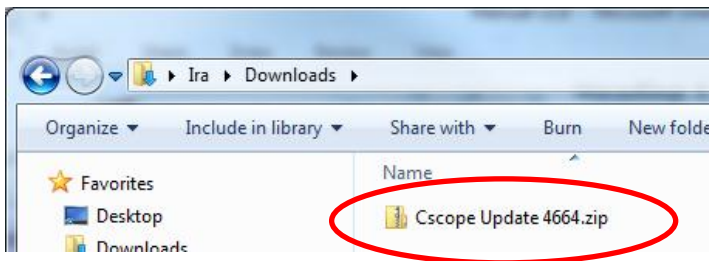

A zipped file will then be downloaded which must be saved.

The filename will have the form *Cscope Update 46xx.zip* where *46xx* is the version number.

In this example the zip file has been saved in the users **Downloads** folder.

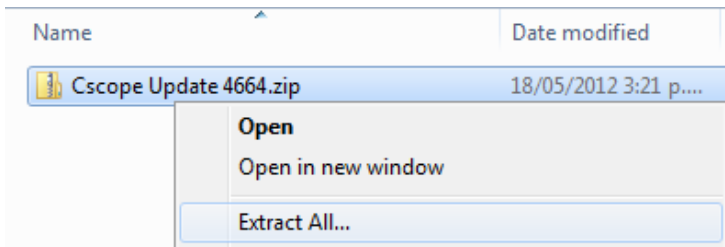

Right-click on the zip file and choose **Extract All**.

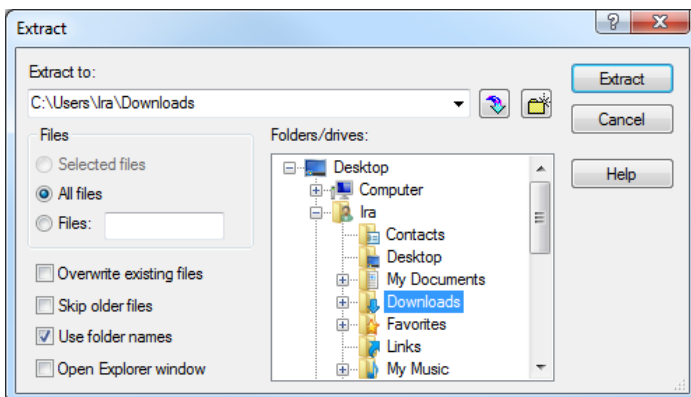

Choose a suitable location to extract to and click **Extract**.

Note The zip file **must** be extracted because the installer (*Setup.exe*) will not run from inside the zip.

Alternatively, but not recommended, you can also use **WinZip** if you have it installed. Open the *Cscope Update 46xx.zip* file, and then click **Extract**.

Make sure you check the **Use folder names** option, choose the folder to **Extract to** and click **Extract**:

Open the *Cscope Update 46xx* folder then open **Setup.exe**. The **Cleverscope Installer** window will open, and four or five choices are presented. Those choices that are already up-to-date will not be checked. However, you can still force an update if required by checking the option. If you are updating drivers, ensure the *Cleverscope Acquisition Unit* is turned **off**.

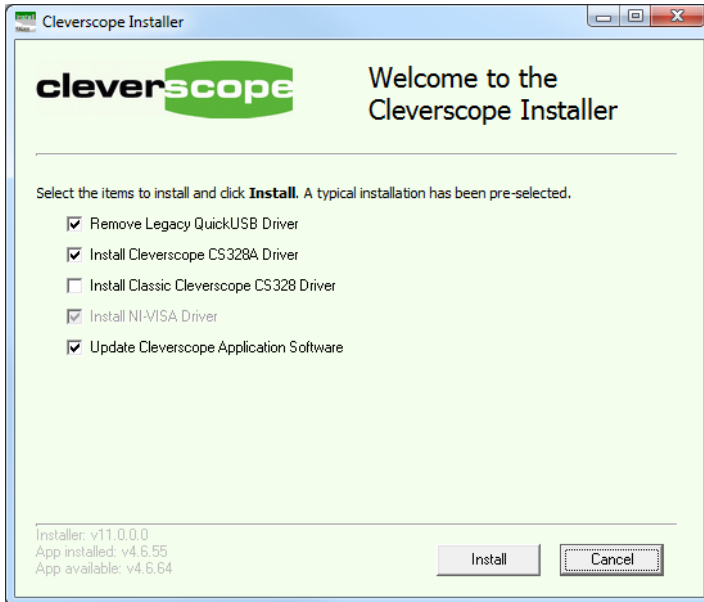

Note Ensure **Install Classic CS328 Driver** is checked if you have the *Classic CS328* (with a serial number less than 4000).

Ensure **Update Cleverscope Application Software** is checked and click **Install**. The installer will update the current copy of **Cleverscope** and any drivers selected. If required, please click **Continue Anyway** while installing the USB drivers. Once finished, click **Finished** to exit the installer.

This completes the application update process. This process does **not** update the firmware. See section 25.8 for updating firmware.

To use the *Cleverscope Acquisition Unit*, plug it in, and turn on the power. If the drivers were updated, the driver will be automatically loaded in **Windows Vista** or **Windows 7**. In **Windows XP** choose to update without connecting to the web, and take defaults from there on.

25.6 Using the Cleverscope Application with a Classic CS320/8

If you are updating the **Cleverscope** application, and you plan to use the application with a *Classic CS320/8*, and you have not used the *Classic CS320/8* before, you will need to install the **Classic Cleverscope CS328 Driver** by checking the option. *Classic Cleverscopes* have a serial number of less than 4000.

25.7 Updating Cleverscope Applications Prior to 6430

If your **Cleverscope** application had a version number prior to 6430, it may have been using the legacy *QuickUSB* driver (CS328A varieties only). This driver is no longer used. If the driver is not required by another application, an additional option will be displayed **Remove Legacy QuickUSB Driver**. If this option is selected, the *QuickUSB* driver will be removed. Make sure you **restart** the computer after the update is complete.

25.8 Firmware Update

Some **Cleverscope** releases require the firmware inside the *Cleverscope Acquisition Unit* to be up to date to take advantage of the latest features (however you can always use earlier versions of the firmware without the added functionality).

When you did the **Cleverscope** application update above, a firmware file of the form *cscope_fw64xx 53yy.cmf* was loaded into your **Cleverscope** programs folder. The *64xx* gives the current firmware version number with the update. Compare this with the current firmware version in your *Cleverscope Acquisition Unit (Cleverscope)* displayed on **ROM Loader** as **FW Ver**. If they are not the same, you will need to update the firmware to gain full advantage of any changes.

Note The *.cmf* file contains the firmware for both *CS328 Classic* and *CS328A* varieties and are version numbers *53yy* and *64xx* respectively.

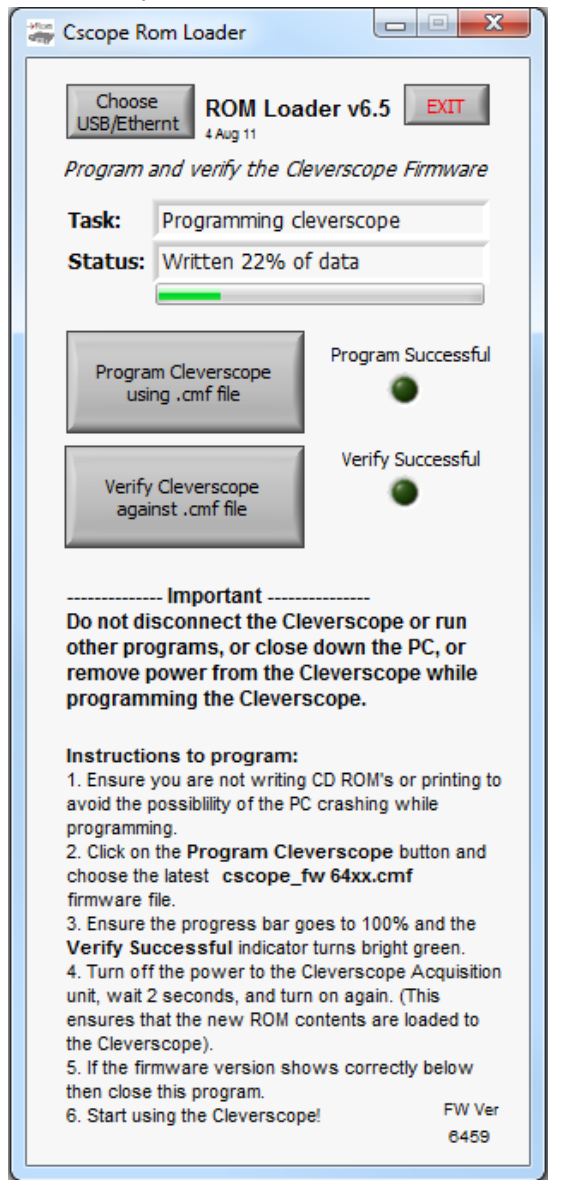
| Firmware Update | To update firmware carry out the following steps: |
|--|---|
|  | <p>Connect the <i>Cleverscope</i>, and cycle the power on it (turn it off, wait 5 seconds, turn it on), to ensure a fresh start. Start Cleverscope ROM Loader, an application that is included in the update, and will be in your Cleverscope programs folder.</p> <p>Important Do not run any other applications, write CD's or do printing while the update is in progress. If power is lost to the <i>Cleverscope</i> during the update you may have to return the unit to the factory.</p> <p>Click Program Cleverscope using .cmf file. Navigate to the Cleverscope programs folder and choose the newest <i>cscope_fw64xx 53yy.cmf</i> (the file contains firmware for all versions of Cleverscope).</p> <p>ROM Loader will now write the firmware to the <i>Cleverscope</i> and light Program Successful when complete. ROM Loader will then proceed to automatically verify the download. If the program and verify were successful you should see:</p> <p>If not, please repeat this step.</p> <p>You may verify the correct <i>.cmf</i> file is loaded at any time by clicking Verify Cleverscope against .cmf file.</p> <p>Important Turn off the power to the <i>Cleverscope</i>. Wait 5 seconds. Turn the power to the <i>Cleverscope</i> back on again. This forces the FPGA inside the <i>Cleverscope</i> to reload the firmware from ROM. Verify that the <i>Cleverscope's</i> green power light is on. Check that the FW Ver shown on ROM Loader now matches the version you programmed.</p> <p>Close ROM Loader by clicking Exit. Your firmware update is now complete.</p> |

25.9 Ethernet Cleverscope Firmware Update

To update the firmware in an *Ethernet Cleverscope* click **Choose USB/Ethernet**. In **Interface Source** select *Ethernet – Find by IP address*. Click on the *Cleverscope* to program in the list, and proceed as above.

25.10 Update a First Generation Installation

If your application version number begins with 3.2 or 3.3, you have an old run time library. You will need to do a new install to obtain the new run time library.

Please carry out the following steps:

Rename the 'Cleverscope' program files folder to 'Cleverscope_old'. Do **not** un-install the old application.

Carry out the steps in **25.2 Cleverscope Application Software First Time** above.

Update the firmware in your *Cleverscope* by following the steps in **25.8 Firmware Update**.

If you are one of the very few customers with a *Cleverscope* with a serial number beginning with 'A00' please contact Cleverscope at support@cleverscope.com before attempting an upgrade.

25.11 Using Windows 98SE, ME and NT

If you use Windows 98SE, ME or NT you will need to download the correct installation or update from the Cleverscope website. You can find these at www.cleverscope.com/resources/. These operating systems are no longer supported, and are only available for the *CS328 Classic*.

26 Calibrate Cleverscope (versions 6442+)

If you are upgrading up from an earlier version to 6442 or later you will need to do a one-time full calibration. The calibration table has changed, and the calibration will update it.

26.1 Calibration Functions

Cleverscope Calibration

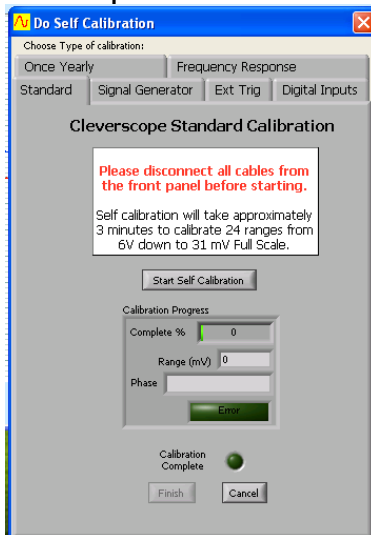

Click on the tab to open the calibration function panel
The calibration functions are as follows

Once Yearly
Standard
Signal Generator
Ext Trig
Digital Inputs
Frequency response

To carry out the calibration follow the steps that follow.

Update your **Cleverscope** application to the latest.
Ensure your *Cleverscope Acquisition Unit* has the latest firmware in it.
Run the application, and use **Auto** to acquire. You should see a trace on the screen.

26.2 Once Yearly Calibration

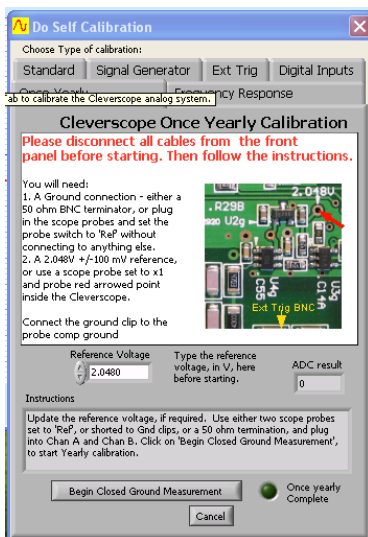

Click **Settings** then **Calibrate Cleverscope**.

Click the **Once Yearly** tab.

Take two Cleverscope scope probes and set the probe switches to *Ref*. This shorts the probe tip to ground. Connect one to Chan A and the other to Chan B. Do not connect the probe tip to anything else. Click **Begin Closed Ground Measurement**.

When the button changes to **Begin Open Measurement**, remove the probes, and click **Begin Open Measurement**.

When the button changes to **Begin Ref A Measurement**, set the probe switch to *1x*, plug one probe into Chan A, connect the ground clip to the front panel test pin with the earth symbol above it, pull off the grabber tip if fitted, and probe the via or component pointed at by the red arrow in the picture. Use firm pressure. It is about 40mm in from the front panel Ext Trig BNC.

Click **Begin Ref A Measurement**.

When the button changes to **Begin Ref B Measurement** move the probe to Chan B, and
Click **Begin Ref B Measurement**.

When the button changes to **Finish** you have completed the *Once Yearly Calibration*.

26.3 Standard Calibration

Next carry out a Standard calibration.

Standard calibration

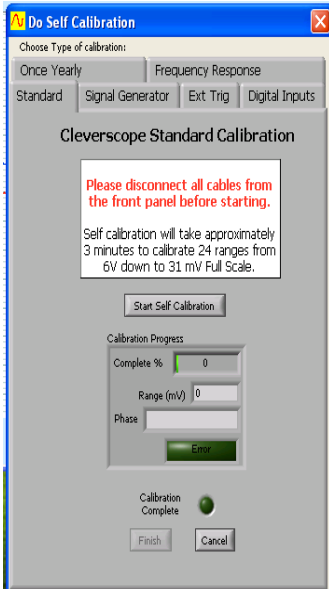

Click the **Standard** tab.

Remove the scope probe from the front panel.

Click **Start Self Calibration** button.

Wait until **Calibration Progress** indicates 100% and **Calibration Complete** indicator glows **Green**.

Click **Finish** when completed.

26.4 Signal Generator Calibration

If your Cleverscope has the CS700A signal generator hardware fitted you may wish to carry out a Sig Gen calibration.

Signal Generator Calibration

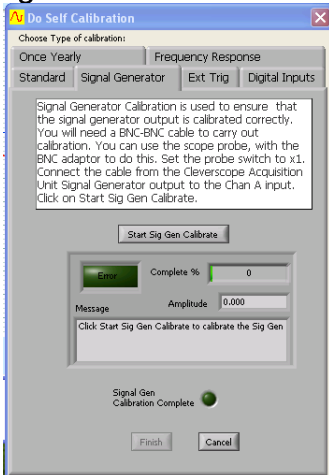

Click the **Signal Generator** tab.

Connect a BNC-BNC cable from the **Signal Generator** to **Channel A**.

Click **Start Sig Gen Calibrate** button.

Wait until progress indicator reaches 100% and **Sig Gen Calibration Complete** indicator glows **Green** and **Finish** button becomes active.

Click **Finish** when completed.

26.5 Digital Inputs Calibration



Click the one lead of a CS2004/5 probe set to **Probe Comp**

Connect a BNC-BNC cable from the Signal Generator to Channel A

Click **Start Sig Gen Calibrate** button

Wait until progress indicator reaches 100% and **Sig Gen Calibration Complete** indicator glows **Green** and **Finish** button becomes active

Click **Finish** when completed

26.6 Frequency Response Calibration

Frequency Response is calibrated during assembly and the trim capacitors are sealed at the factory and seldom require adjustment.

Important: If there is significant overshoot you will need to open the unit and remove the sealing glue to be able to adjust the trim capacitors to get a square wave without overshoot.

With the power OFF use a Philips screwdriver to undo the two screws on the bottom of the Cleverscope case assembly. Remove the lid, and power up with the lid still off. Leave it powered for 30 minutes to stabilise operating temperature.

Frequency Response Calibration

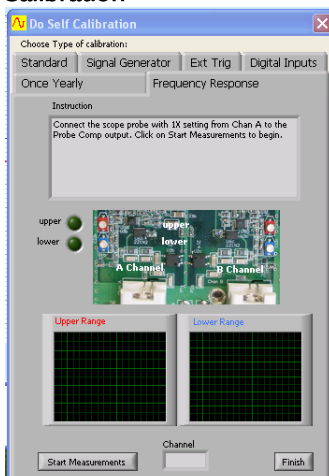

Click the **Frequency Response** tab.

Connect a BNC-BNC cable from the Signal Generator to Channel A.

Click **Start Measurements** button.

Switch Channel to Repeat for Channel B

Click **Finish** when completed.

Power off and replace the lid taking care not to over-tighten the case screws.

26.7 Ext Trig Calibration

External Trigger Calibration

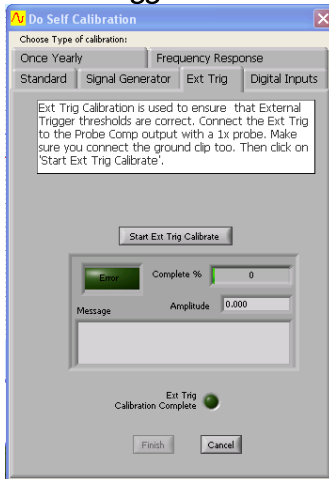

Click the **Ext Trig** tab.

Connect a probe from Probe Comp to the Ext Trig input and connect probe ground

Click **Start Ext Trig Calibrate** button.

Wait until progress indicator reaches 100% and **Ext Trig Calibration Complete** indicator glows **Green** and **Finish** button becomes active.

Click **Finish** when completed.

27 Cleverscope Support

The Cleverscope software has been developed by Cleverscope Ltd. as a tool for displaying and manipulating captured analog electrical signals on a PC.

It can be set to work with a variety of other signal acquirers including the Strobes 901/901A Acquisition Units or an internal soundcard.

If you are having problems please check the **Forums** on the Cleverscope website www.cleverscope.com. If you still can't resolve your problem please contact us at:

Email support@cleverscope.com

Phone +64 9 524 7456

Mail Cleverscope Ltd.
PO Box 26527
Epsom
Auckland 1344
New Zealand

27.1 Minimum PC Requirements

The minimum PC requirements to use the Cleverscope CS328A are a Pentium class computer with at least 256 Mbyte of memory, running Windows 2000 or later.

27.2 Evaluation Software

An evaluation version of the Cleverscope application software is available from the Cleverscope website at www.cleverscope.com.

Visit the www.cleverscope.com site, and then go to the **Evaluate and Subscribe** section shown below.

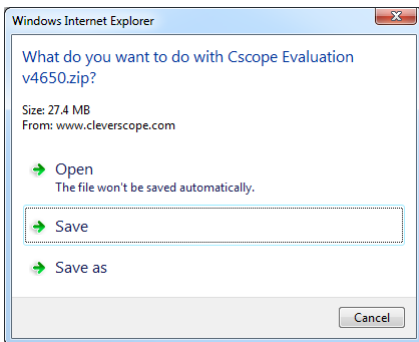
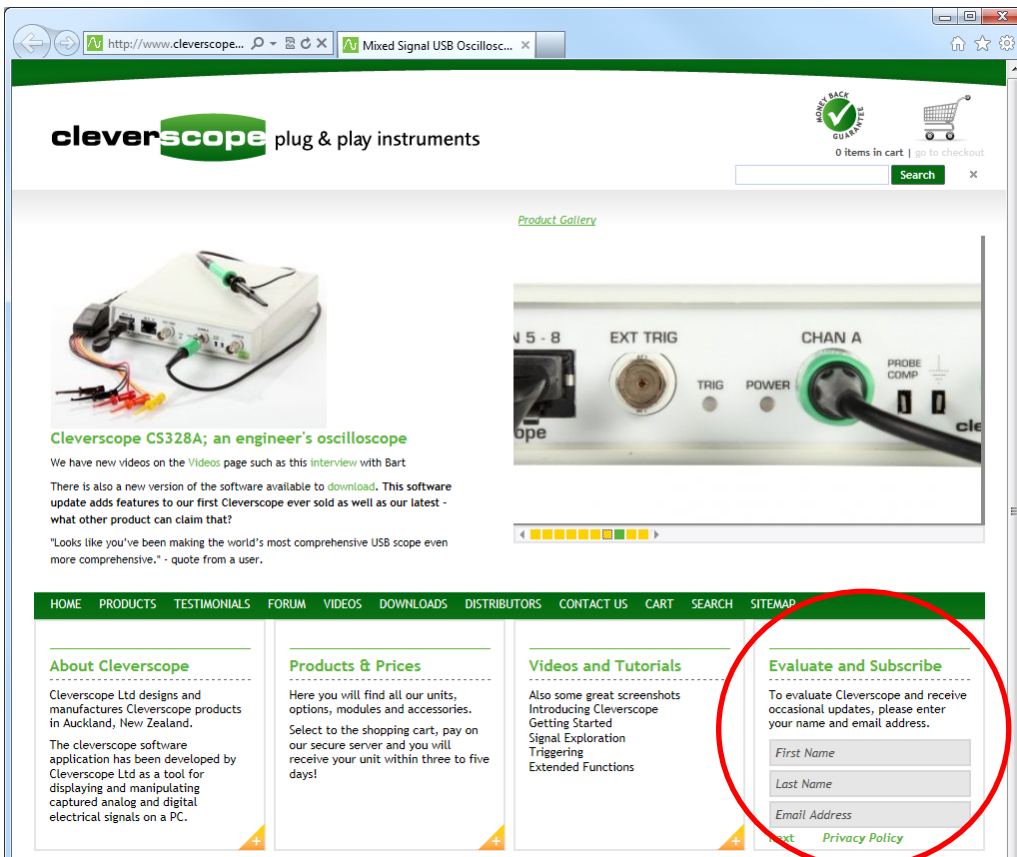

Fill in your name and email and click **Next**. Click on the download. Choose the option of saving the zip file rather than opening it.

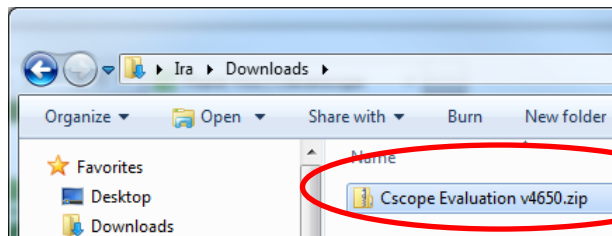

A zipped file will then be downloaded which must be saved. In this example it has been saved in the users **Downloads** folder.

Right-click on the zip file and choose **Extract All**.

Choose a suitable location to extract to and click **Extract**.

Note The zip file **must** be extracted because the installer (*Setup.exe*) will not run from inside the zip.

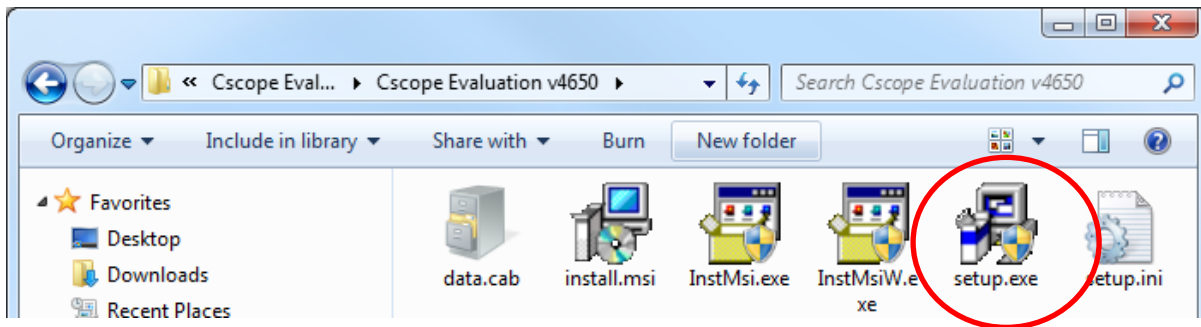

Open **setup.exe** to run the **Cleverscope** installer. The installer will create a **Cleverscope** folder in your program files folder and save a number of files into it.

It will also create a desktop icon and an entry in the programs menu under the Windows  start orb.

You can now run an evaluation version of **Cleverscope**.

28 Cleverscope Specification

28.1 Signal Acquisition

| | |
|----------------------------------|---|
| Acquisition Output Waveforms | Sampled, Peak Detected, Filtered, Averaged in PC, Averaged in Acquisition Unit, and Spectrum |
| Acquisition Modes | Single Shot, Triggered, Automatic, Repetitive (High Frequency), Multiple Frame |
| Acquisition Rate to PC, via USB | 20 Frames per second |
| Acquisition Rate, multiple frame | Continuous capture until buffer is full (2 - 3000 frames of 4M - 1300 samples) |
| Filtering | Moving average filter with 40n – 1.28us time constant. Resolution improvement to 12 or 14 bits. 20 MHz anti-alias filter. |

28.2 Analog Inputs

| | |
|--|---|
| Number | 2 |
| Input Coupling | DC, AC, GND |
| Input Impedance, DC coupled, all channels | 1 M Ω \pm 2% in parallel with 20 pF \pm 3 pF |
| Probe Attenuation (CS200xx) | 1X, 10X |
| Maximum Voltage between Signal and Common at input BNC | 300 Vrms (420V peak, duty cycle <50%, pulse width <100 ms) For steady state sinusoidal waveforms, de-rate at 20 dB/decade above 100 kHz to 10 Vpk at 3MHz and above. |
| Time delay between channels, typical | 200 ps |
| Channel to Channel Crosstalk, typical | -70 dB at 20 MHz, signal at 0.5 Full Scale. |

28.3 Vertical

| | |
|--|--|
| Digitizers | 10, 12 or 14 bit resolution module options |
| Full Scale Volts Range | 40 mV to 20V, 1X probe |
| Resolution | 0.02 mV for 20 mV Full Scale. |
| Position Range | Full Scale Range as above moved anywhere in the range \pm 2.5V with 10mV resolution for full scale less than 5V, and Full Scale Range as above moved anywhere in the range \pm 20V with 100mV resolution for full scale greater than 5V. |
| Analog Bandwidth | 100 MHz, -3dB |
| Instantaneous Capture Bandwidth | 25 MHz |
| Repetitive Sampling Bandwidth | 100 MHz, -3 dB |
| Analog Bandwidth in Peak Detect Mode | 50 MHz |
| Analog Bandwidth with Anti-Aliasing filter on | 20 MHz |
| Analog Bandwidth with Moving average filter on | 0.3 - 20 MHz (6 settings) |
| Lower Frequency limit, AC coupled | 10 Hz, 1x probe, 1Hz, 10x probe |
| Rise time at the BNC, typical | <3.5 ns |
| Peak detect response | Captures all pulses >10 ns in duration. |
| DC Gain accuracy | \pm 1% for Sample or Averaged acquisition mode |

| | |
|-------------------------|--|
| DC Measurement accuracy | ±1% for Sample or Averaged acquisition mode +0.1 divisions. |
| Delta Volts measurement | Volts between any two points, ±1% for Sample or Averaged acquisition mode +0.02 divisions. |

28.4 Horizontal

| | |
|-------------------------------------|---|
| Sample Rate Range | 100 MSamples/s to 1500 MSamples/s |
| Waveform interpolation | Sin(x)/x |
| Record Length | 1024 – 4 000 000 samples for each channel |
| Sec/Div Range | 1 ns/div to 5 s/div in 1,2,5 sequence |
| Sample Rate and Delay time Accuracy | +/-50 ppm over any >1 ms interval |
| Sample Clock jitter, typical | 1 ps RMS |
| Delta Time Measurement Accuracy | (±1 sample interval + 50 ppm +0.4 ns). |
| Position Range | +/- 21.47 seconds of the trigger point, with 10 ns resolution. |
| Captured Sample window duration | 1 µs – 40 ms with 10ns resolution 40 ms – 42.9 seconds with 10 ns - 10 µs resolution. (Lower sample rates are available for smaller capture buffer sizes) |

28.5 Triggering

| | |
|-------------------------------------|--|
| Number of triggers | 2 |
| Trigger sources | Each trigger can be independently set to source from Channel A, Channel B, Ext Trig, Link Input, and Digital Inputs 1-8 as a pattern. |
| Trigger Sensitivity, Edge Triggered | Analog Channels – 0.2 Div from DC to 50 MHz External Trigger – 50 mV from DC to 100 MHz Digital Inputs – 100 mV from DC to 100 MHz |
| Trigger Modes | Edge, Pattern, Pulse Duration, Voltage slope, Voltage Window, Count, OR combination of duration and count. |
| Trigger Filtering | Noise reject, HF reject, LF reject |
| Trigger Level Range | Internal: ±10 divisions from centre of screen External: -8 – +18V in 40 mV increments Digital: 0 – 8V in 10 mV steps |
| Trigger Level Accuracy | Internal: ±1% External: ±3% + 50 mV Digital: ±3% + 100 mV |
| Trigger Delay Range | 0 – 21.47 sec with 10ns resolution. |

28.6 Digital Inputs (CS328A)

| | |
|-----------------------|--|
| Number | 8 |
| Input impedance | 100kΩ ±2% in parallel with 10 pF ±2 pF |
| Input voltage range | -16V to + 20V |
| Threshold range | 0 – 8V in 10 mV steps |
| Threshold sensitivity | 100 mV |
| Sample Rate | 100 MSamples/sec |

28.7 Measurements

| | |
|---------|--|
| Cursors | Voltage Difference between cursors Time difference between cursors Reciprocal of ΔT in Hertz (1/ΔT). |
|---------|--|

| | |
|------------------------|---|
| Automated measurements | DC component RMS value Maximum voltage Minimum Voltage Peak-Peak Standard deviation Period Fundamental Signal Frequency Fundamental Signal Amplitude Pulse width Duty Cycle Freq and Amplitude for fundamental + second and third harmonics THD SINAD HD2+3 |
| Custom units | 6 characters |
| Custom signal names | 20 characters |
| Custom scaling | Scale + offset by defining two (Vin, Vout) points |
| User definable colours | Signals, Background, Major Grid, Minor Grid |

28.8 PC Interface

| | |
|---------------------------|------------------------|
| USB Interface | USB 2.0 (480 Mbit/sec) |
| Effective Throughput rate | 18 Mbyte/sec |
| Isolation | None |

| | |
|---------------------------|---|
| Ethernet Interface | Ethernet (100 Mbit/sec) |
| Effective Throughput rate | 6 Mbyte/sec |
| Isolation | 20 pF, 1500VAC isolation |
| Ethernet connectivity | DHCP or Point-to-Point or IP addresses. Cable direction auto-sense. |

28.9 Calibration

| | |
|----------------------------|--|
| Calibration method | Automatic self-calibration |
| Calibration Voltage Source | Range $\pm 2.5V$ Resolution 1 mV Drift 11 ppm/ $^{\circ}C$ Accuracy $\pm 1\%$ |
| Temperature Compensation | Via Internal temperature sensor, $\pm 1.5^{\circ}C$ accuracy |

28.10 Displays

| | |
|-------------------------|---|
| Windows | Simultaneous Capture, Tracking, Spectrum, Information, Maths, XY, Control Panel and Protocol setup windows |
| Scope Display (Capture) | Defines capture specification for signal acquisition unit, defining amount of time before trigger, amount of time after the trigger, lower amplitude limit, upper amplitude limit. Defines tracking graph time position, when displays are linked. Defines trigger level and direction Full zoom and Pan in both axis. Annotations. Custom colours |
| Tracking Display | Displays zoomed section of captured signal. Resolution from 10ns to 5s/div. |

| | |
|---------------------------|---|
| | Full zoom and Pan in both axis. Annotations. Custom colours |
| Spectrum Display | Display spectrum of signal captured in capture window. User definable resolution Full zoom and Pan in both axis. Annotations. Custom colours |
| Maths Display | Displays results of Maths equations. Maths equations are user entered expressions involving any of the inputs (analog and digital), previous maths equation line results, and an arbitrary number of function results (+ - * / sqrt, power, log, ln, all transcendental functions, equality functions). Provide live Matlab link. |
| XY Display | Displays XY display from source (Capture, tracking, spectrum, or Maths |
| Signal Information | Displays automated measurements (see below) Used to log derived information values to disk, with a period of between 0.05 – 86,400 seconds per sample. Live logging to Excel DDE live value transfer to Excel. |
| Cleverscope Control Panel | Provides Trigger settings – analog and digital Provides Sample control – single, triggered or automatic. Provides access to tools – Pan, Zoom, Annotate Controls Frame store Controls Spectrum resolution, acquisition method and averaging |
| Protocol Setup | Provides protocol setup for I2C, SPI, UART and parallel bus. |

28.11 Mathematical Functions

| | |
|---|---|
| Functions over the signal | Differentiation, Integration, Filtering, Power functions, Matlab interface, Signal Processing functions |
| Functions on a data point | Addition, subtraction, multiplication, division, squaring, square root, (inverse) sine, cosine, tangent, tangent, log, sign etc. Equality operations. |
| Maximum number of sequential mathematical equations | 10 |

28.12 Spectrum Analysis

| | |
|----------------------|--|
| Frequency Range | User definable, Range = 0- 1/Scope Display ΔT , Frequency axis – log or linear. |
| Analysis Output | RMS Amplitude, Power, Power Density, Gain/Phase |
| Frequency Resolution | Spectrum has from 1024 to 1048576 points (50 Hz in 50 MHz). |
| Output type | Volts, Power, Gain/Phase in linear, dB, degree or radian values. Custom units can be applied. |
| Window types | None, Hanning, Hamming, Blackman-Harris, Flat top, Low Sidelobe |
| Averaging | Moving average, block average, peak hold. |
| Averaging method | Vector averaging in time domain if triggered. RMS averaging in frequency domain if not triggered. |

28.13 Protocol Decode

| | |
|---------------------------|--|
| Protocols | I ² C, SPI, UART and parallel bus. |
| Protocol decode inputs | Digital Inputs 1-8, External trigger, Channels A, B User defined threshold when using analog inputs |
| Protocol decode variables | Number of bits, Clock edge rising or falling, Bit invert/non Invert, Select |

| | |
|---------------------|---|
| | Hi/Lo, MSB first or not, Number of stop bits. |
| Output display type | Naming label. Character, Hexadecimal or Decimal Number. Colour. |

28.14 Charting

| | |
|---------------------|--|
| Sampling Rate | 1 Sample per Second – 1.5 Mega Samples Per Second (Can be increased to |
| Sample preparation | Peak capture or Moving average filter prior to decimation. Using 1.28us filter with 12 or 14 bit ADC we achieve 16 bits ENOB at 1 MSPS. |
| Sample storage | Up to 500 G samples. Samples are stored in multiple smaller files to increase speed. |
| Review capabilities | Zoom and pan anywhere in sample space. Samples are displayed peak captured (i.e. 1us pulse will still be visible in 1 day long sample record). |
| Export capabilities | Export tab delimited text, binary, or Cleverscope format file. Output between markers, or current display. Set output depth. |

28.15 Data Export

| | |
|-------------------|--|
| File types output | Cleverscope proprietary, Tab delimited text (Excel compatible), Excel file (for signal information logging). |
| Live Data output | DDE to Excel, direct placement of data into live Excel sheet Live data output to and return from Matlab |

28.16 Windows Facilities

| | |
|----------------------------|--|
| Standard Functions | Copy and Paste Save and Open native format (saves full setup) Save and Open tab delimited text file Save and Open binary file (start time, dt, data) Print with Date/Time, File Name and Description. Print Setup |
| Windows | Dynamically resized Can be placed anywhere on desktop |
| User settable units | 6 characters |
| User settable signal names | 20 characters |
| User settable scaling | Scale + offset by defining two (Vin, Vout) points |
| User definable colours | Signals, Background, Major Grid, Minor Grid |

28.17 Probe Compensator Output

| | |
|-------------------------|---------------------|
| Output Voltage, typical | 2V into >100kΩ load |
| Output Frequency | 1 kHz |

28.18 Power Source

| | |
|--------------------------------------|-----------------------|
| Source voltage into unit | 6-20V DC |
| Power Consumption | 6W |
| Standard power adaptor voltage range | 100 – 240VAC 50-60 Hz |

28.19 Environmental

| | |
|-------------|--|
| Temperature | Operating: 0°C to +40°C Storage: -20°C to +60°C |
|-------------|--|

| | |
|----------------|---|
| Cooling Method | Convection |
| Humidity | 0°C to +40°C <90% relative humidity >40°C <60% relative humidity |
| Altitude | Operating 3,000 m Non-operating 15,000m |

28.20 Mechanical

| | |
|------------------|--|
| Size | Height 35 mm Width 153 mm Depth 195 mm (including BNC) |
| Weight (approx.) | Standard packaging: 1.6 kg |

28.21 Expansion Capability - Signal Generator Module CS700A

| | |
|----------------------------------|---|
| Function | Generate Sine, Square or Triangle output signals |
| Generation Method | Direct Digital Synthesis |
| Output Sampling Rate | 50 MSamples/sec |
| Frequency Range | Sine, Square: 0.2 Hz – 10 MHz Triangle: 0.2 – 1 MHz |
| Resolution | 0.003 (<750 kHz) or 0.2 (<10 MHz) Hz |
| Accuracy | 50 ppm in 1 year, 0-40 deg C |
| Output Voltage Range | 300mV – ±5V p-p including DC offset |
| Output Voltage Resolution | 10 mV |
| Output Impedance | 50 ohm |
| Output Voltage Offset Range | -4 to +4V |
| Output Voltage Offset Resolution | 10 mV |
| Frequency Shift Range | Any two frequencies in range 0.2Hz – 10 MHz |
| Signal to Noise Ratio | -60 dBc typical |
| Total Harmonic Distortion | 0 – 1 MHz : < -60 dBc > 1 MHz: < -45 dBc |
| Amplitude Flatness | ± 0.2 dB |
| Amplitude Accuracy | ± 2% |
| Square Wave Rise/Fall Times | < 12 ns |
| Protection | Short Circuit Protected ± 10V peak overdrive < 1 min |

28.22 Expansion Capability – Increase Sampling Channels and Sample Rate

| | |
|--------------------------------------|--|
| 4 analog, and 16 digital channels | Connect two units together with Trigger Link Cable (CS20xx) Uses two computer USB ports |
| Increase in sampling rate to 200MSPS | Uses 5ns delay line (CS@XXX), and the Maths 'Interleave' function |

28.23 Cleverscope Hardware Resources

Two 10 bit, 12bit, or 14 bit analog channels sampling simultaneously at 100 MSamples/s. AC or DC coupled. The bit resolution is field upgradeable by changing the sampler circuit board.

Scaling and offsetting to view 50mV full scale offset to any value between -8 and +8 V.

Gain automatically set from 20mV full scale to 800V full scale by choosing graph view and probe switch setting. Offset automatically set from 0 to ± 4 or 40V in 10/100 mV increments by choosing graph view. As an example 20 mV signals may be viewed superimposed on a 3V DC level.

Analog triggering of the waveform in view with a resolution of 1% of the graph height. The analog trigger may optionally be conditioned with a low pass, high pass or noise filter.

One external trigger with threshold adjustable from -8 to +18V in 40 mV increments.

Eight digital inputs sampling at 100 MSamples/s with threshold adjustable from 0 to 8 V in 10 mV increments.

A hardware trigger system based on a rising or falling edge on any input signal, optionally qualified by a user determined digital input combination and a minimum or maximum trigger duration.

A rear panel I/O connector with a 100 Mbit/s bi-directional LVDS/RS422 link, and three RS422 outputs defaulting to sampling started, trigger received and sampling stopped.

Each channel (two analog, trigger and 8 digital) includes 4M samples of storage, providing up to 40 ms of simultaneous storage for all channels, with 10 ns resolution.

The sample storage may be allocated as between 2 to 1000 frames varying in size from 2M to 4000 samples.

These may be used as a history store for reviewing previously captured signals, or to capture up to 1000 trigger events with a minimal 2 μ s inter-frame delay, while maintaining time relative to the first trigger for all succeeding frames.

25 MHz 5th order Anti-alias filter for improved Spectrum Analysis performance.

Triggered LED and Power LED on the front panel.

Input power range from 6 ~ 12V, 5W provided by a universal mains adaptor.

Low jitter (1 ps RMS) sampling clock for 70 dB spurious free dynamic range.

Self-calibration to ensure DC performance specifications is met.

An optional plug-in signal generator, 0-10MHz, sine, square or triangle.

Enclosure size: 153 x 195 x 35 mm.

28.24 Cleverscope Application Software Resources:

Separate, freely moveable and resizable windows to display the signal, a zoomed signal view, the frequency spectrum of the signal, and the Control Panel.

The zoomed signal view optionally tracks the signal view cursor.

Spectrum analysis with a variety of conditioning windows and displays in log or linear format.

Each signal window includes a time/amplitude tracer, and two markers for comparison purposes. Colours are user definable.

Signal averaging (exponential, block and peak hold) and low pass filtering.

Full mathematical functions including + - / * sqrt integral differential and filtering.

Signal measurement, including Peak to Peak, RMS, DC, pulse width, period and frequency.

Copy and Paste graphs or data to other applications.

Save and Open from disk.

User defined units, signal names and scaling (offset and gain).

Text annotation of each graph

Web server for remote viewing of LAN connected unit.

29 Appendix 1 – Document Control

| Document Version | Date | Cleverscope Version | Description of Changes | Author |
|------------------|----------------------|---------------------|---|--------------------------------|
| 1.0 | 27/8/04 | V 2.2 | First Draft | ATG |
| 1.1 | 7 /9/04 | V3.1 | Small additions | BES |
| 1.2 | 11/3/05 | V3.2 | Removed registration description | BES |
| 2.1 | 12/08/05 | V3.418 | Basic reformat Add Sig Gen & Digital Inputs Add Maths Equation Builder Update all pictures | IJH |
| 2.2 | 3/02/06 | V3.509 | Add Period Trigger Add Waveform Averaging | IJH |
| 2.3 | 17/02/06 | V3.510 | Various minor corrections | IJH |
| 2.4 | 11/12/06 | V3.524 | Update Signal Information Update Sig Gen Controls Remove Walkthrough Add Quick Getting Started Update screenshots Add File Logging Add XY Graph Add Maths Graph | IJH |
| 2.5 | 30/07/07 | V4.615 | Update screenshots Add Graph knob palette Add Graph fine pan Add Autoset Updated Quick Getting Started Guide to include Autoset | IJH |
| 2.6 | 25/02/09 | V4.635 | Change format from 2-up to 1-up per A4 & front cover to editable Update Choose Acquirer and set connection, Sig Gen wave types, Maths processes, screenshots Add info & graph sources, Protocol Decoder and Setup, Trigger Time, Info logging & DDE Add Using the Ethernet Cleverscope section Re-organised sections Add Heading numbering & pictures to protocol section. Small edits. | IJH BES |
| 2.7 | 24/09/10 | V4.651 | Update screenshots Update Spectrum Graph (Y Scale & Freq Scale buttons) Update front end filter Add Persistence Add Charting, Add Export Charting & Update File Options for charting Add Matlab Usage under Maths section | IJH BES |
| 2.8 | 11/06/12 | V4.664 | Update screenshots Update Specifications Update Maths Equation Builder processes & functions Update Filter button peak-captured decimation feature Update Tracer Cursor Style Update Cleverscope Support Add Pulse Signal Information Add Auto get and Frame Replay Add Updating Cleverscope | IJH |
| 2.9 | 29/04/13 28/01/14 | V4.684 | Revised and updated FRA added | AKD BES,AKD |

30 Appendix 2 - Keyboard Shortcuts

As well as using the mouse to navigate and control Cleverscope there are a number of keyboard shortcuts that can be used to save time and improve ergonomics. These are described below:

Movement:

← and → move the cursor left and right
Shift + ← and → move the graph left and right
Ctrl + ← and → change the x-scale up or down

↑ and ↓ move the selected graph up and down
Shift + ↑ and ↓ move the selected graph up and down
Ctrl + ↑ and ↓ change the y-scale up and down

Markers:

1 and 2 set markers one and two
Spacebar sets the next marker

Graph Viewing:

Tab swaps channels
A autoscales the graphs
PageDown zooms in on the tracer
PageUp zooms out on the tracer
L locks the tracking display position on the current scope display tracer position
F10 automatically sets the graph scales and trigger settings

Control:

C or **Ctrl** + **C** copies the graph to the clipboard
X or **Ctrl** + **X** clears the graph
P or **Ctrl** + **P** prints the graph
F1 chooses the Pan/Tracer cursor
F2 chooses the Annotation cursor
F3 chooses the Rising Trigger cursor
F4 chooses the Falling Trigger cursor

Sampling:

F7 initiates a single acquisition
F8 initiates automatic acquisition
F9 initiates triggered acquisition

Mouse Wheel:

The mouse wheel acts as a virtual knob on whatever control was last selected. So if you select the Chan A Contract button, and then use the Mouse Wheel, the wheel acts as a virtual knob on the Channel A Volts/div.

Note You can copy the keyboard shortcut control list from the **About Cleverscope** window and paste wherever it is helpful for you.

Distribution in the UK & Ireland



**Characterisation,
Measurement &
Analysis**

Lambda Photometrics Limited
Lambda House Batford Mill
Harpenden Herts AL5 5BZ
United Kingdom
E: info@lambdaphoto.co.uk
W: www.lambdaphoto.co.uk
T: +44 (0)1582 764334
F: +44 (0)1582 712084