

FT68200A/AL/E series

Ultra-high power electronic load



www.lambdaphoto.co.uk

T: +44 (0)1582 764334

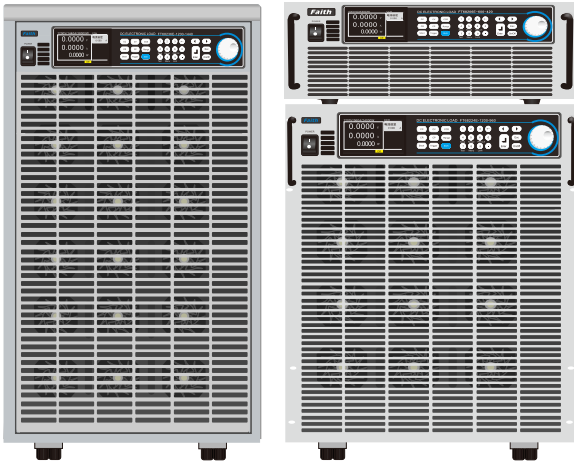

Characteristics

- Single power: 4kW ~ 60kW, the maximum power can be extended to 600kW through the master/slave parallel;
- Power density 6kW/3U;
- Voltage range: 150V, 600V, 1200V, 1600V;
- Current range :100A/kW(150V), 70A/kW(600V), 40A/kW(1200V), 20A/kW(1600V);
- High precision, voltage accuracy is (0.025%+0.025%F.S.);
- The current accuracy is (0.05%+0.05%F.S.);
- Multiple working modes: CC, CV, CR, CP, CRD, CPD, CV+CC, CR+CC, CP+CC operation mode;
- Programming speed 50kHz, sampling speed 500kHz;
- 30kHz dynamic scanning function;
- The remote data transmission rate can reach 1kHz, which can greatly improve the data acquisition ability of the communication interface;
- Instantaneous overpower with load function, instantaneous overload capacity more than twice the rated power;
- OCP, OPP, LED simulation, load effect, battery internal resistance, battery discharge test function;
- Time measurement, (Vpk+/-) measurement function;
- Automatic test function, sine wave band load function, sequence function, MPPT function;
- Comprehensive protection functions: over-voltage, over-current, over-temperature, current limit, power limit, reverse connection alarm, and power failure memory;
- External analog programming input and current monitoring output with high voltage isolation capability;
- TFT color LCD screen, English and Chinese menu interface;
- Equipped with various communication interfaces: RS232, RS485, LAN, USB, GPIB (optional), CAN (optional), USB-TMC(optional) ;
- Supports SCPI and ModBus communication protocols.

Summary

The FT68200A/AL/E series of high power programmable DC electronic loads is designed for high reliability and high power density, which is twice the power density of traditional loads.

FT68200A/AL/E series has 150V, 600V, 1200V, 1600V four voltage ranges, single power range from 4kW to 60kW, a single current up to 2400A. Its wider working range and extremely fast dynamic frequency effectively increase the test capability and application range. The whole series of products have strong overload capacity, and the instantaneous over-power pulling can reach 2 times the rated power, which can effectively reduce the test cost.

FT68200A/AL/E has LAN, RS232, RS485, CAN, GPIB, USB and other communication interfaces as well as analog interfaces. It supports both SCPI and ModBus communication protocols, which provides great convenience for system integration applications.

Application filed

- Power battery, lead-acid battery, fuel cell discharge test;
- BMS and battery protection device testing;
- Dc charging pile, charging module, vehicle charger, A/D power converter and other power electronic power device testing;
- Test high-power switching power supply, UPS power supply, communication power supply, server power supply;
- Virtual load testing of solar arrays and industrial motorsl.

Ultra high power density

The FT68200A/AL/E series features a high power density design that is only half the size and one-third less weight than conventional electronic loads.

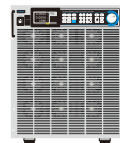

24kW / 14U

VS



General Electronic Load

1kHz data transmission

FT68200A/AL/E series can provide users with up to 1kHz data transmission, that is, 1000 voltage and current data points per second, in order to achieve waveform rendering and dynamic data analysis and other functions. In the application of system integration, the host computer can get a lot of test data directly and reduce the cost by this function without oscilloscope and high-speed current acquisition hardware.



Multi-interface and multi-protocol

The FT68200A/AL/E series is equipped with a variety of communication interfaces, and supports both SCPI and Modbus communication protocols. Users can configure the system on the menu according to their needs, which makes the system integration more flexible.

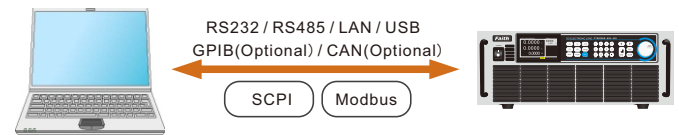

Cascade

The cascade function of the FT68200A/AL/E series supports the parallel use of up to 10 loads, extending the power usage range of electronic loads. During the cascading process, each load automatically equalizes traffic, and the slave automatically copies the load parameters of the host. Single machine can also be used independently, more flexible power configuration.

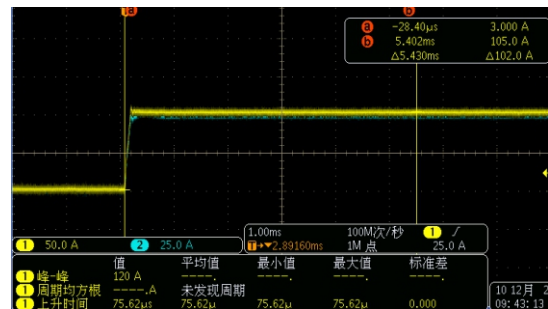
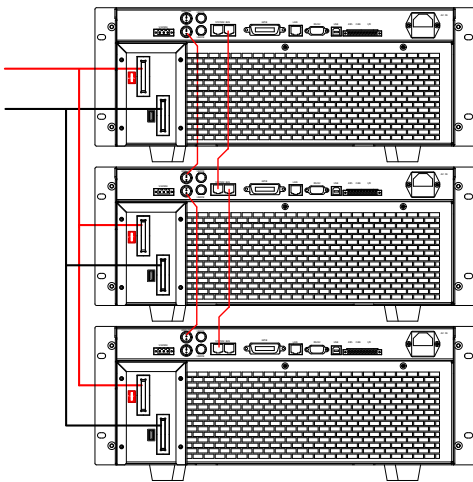

When two master-slave cascades are loaded, the current waveforms coincide completely

Multiple operating modes

FT68200A/AL/E series has four basic operating modes of constant current, constant voltage, constant resistance and constant power, which can meet a wide range of test needs. At the same time, it also has the function of CV+CC, CR+CC, CP+CC multiple composite operation modes. Users can set the current limit value according to their own test requirements to avoid overcurrent damage to the test product during the test process. Among them, CV+CC mode can be applied to simulate battery charging characteristics, test charging piles and similar products such as vehicle chargers. CR+CC mode simulates power supply voltage current limitation and accuracy testing.

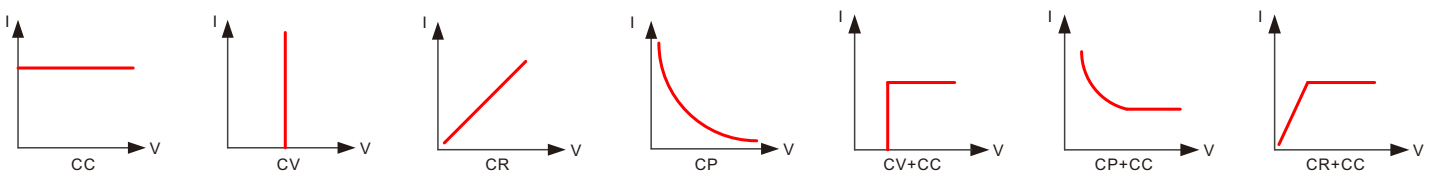

30kHz dynamic sweep, Vpk+/- capture

FT68200A/AL/E series with dynamic sweep function, the maximum frequency can be set 30kHz. During the test, the peak voltage Vpk+, valley voltage Vpk- and the occurrence frequency of the measured power supply are captured and recorded by adjusting the current pulling frequency. It can effectively test the dynamic response of various power supplies at different frequencies.

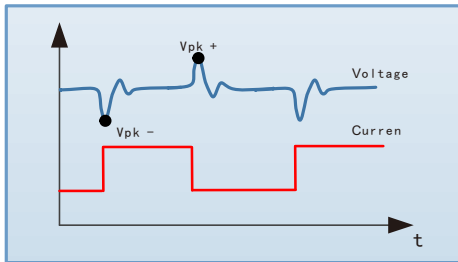

Battery test

FT68200A/AL/E series electronic load with battery test function. Three discharge modes of fixed current, fixed resistance and fixed power are provided, and the discharge cutoff conditions can be set by itself: cut-off voltage, cut-off time and cut-off power. If any of the three conditions are met, the discharge stops. During the discharge process, the discharge quantity and discharge time are recorded.

The FT68200A/AL/E series is tested for internal resistance and capacity by direct current discharge (DCIR).

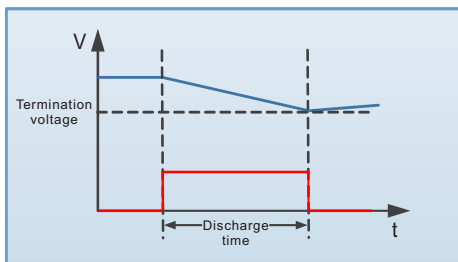

Sine wave dynamic load

The FT68200A/AL/E series has sine-wave current-carrying function and can be used for impedance analysis and testing of fuel cells.



Sequence function

The FT68200A/AL/E series of electronic loads provides sequential test capabilities for editing up to 20 test files with 100 steps each. It supports load timing changes in CC, CV, CR, CP and other modes, and also supports sequence editing functions such as file link. A maximum of 2000 steps can be edited (5000 steps can be customized). The time range of a single step is 0.1ms to 99999s.

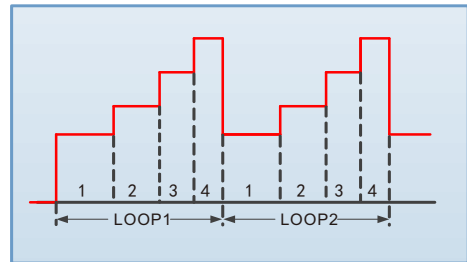

Time measurement

FT68200A/AL/E series electronic load with time measurement function. By capturing the external switching signal, combined with the switching signal and the voltage and current signal, the response and operation time of the system and the pulse width of the pulse current can be measured. It is mainly used to measure the on-off time, holding time, rising edge and falling edge time of the power supply, as well as the fuse fuse time and circuit breaker response time.

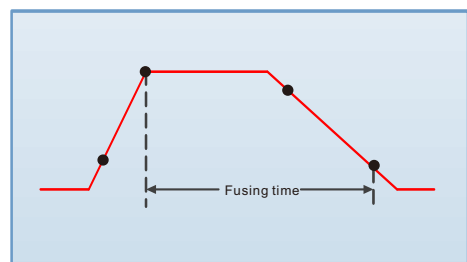

Instantaneous overpower loading function

The FT68200A/AL/E series electronic load has the instantaneous loading capacity of 2 times the rated power. In simulating DC motor starting characteristics, instantaneous overload characteristics of power supply, instantaneous high-rate discharge characteristics of power battery, instantaneous load capacity of power electronic devices and other instantaneous high-power loading test, it can greatly save costs.

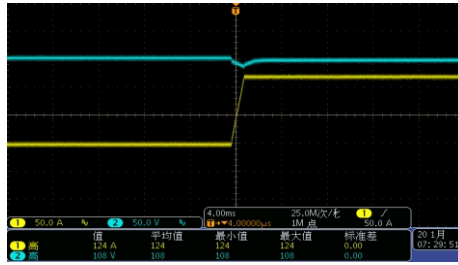

The FT68206E-150-600 is rated at 6kW and carries 12kW instantly

External analog programming

The FT68200A/AL/E series has external analog programming capabilities. Other devices can continuously control the load via an external voltage signal (DC or AC). The external voltage signal of 0 ~ 10V corresponds to 0 ~ 100% full scale on-load current. This function can also be used for various complex band carrier shape test.

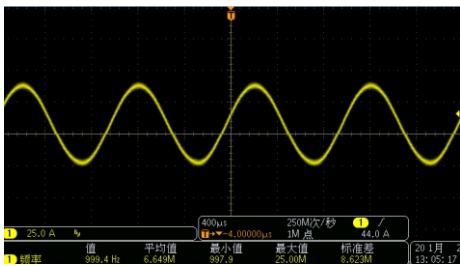

1kHz sine wave

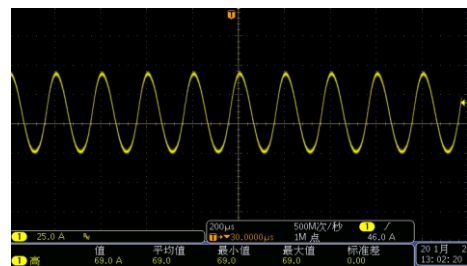

5kHz sine wave

Computer graphical operation software

FT68200A/AL/E series provides a host computer software with virtual instrument function, which can read test data in real time, generate images, export reports, print reports, etc., which is convenient for customers to use.

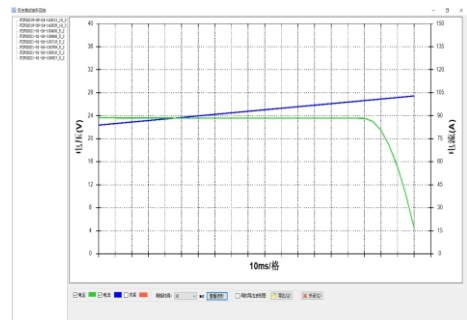
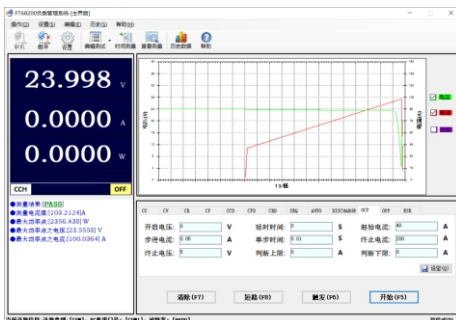
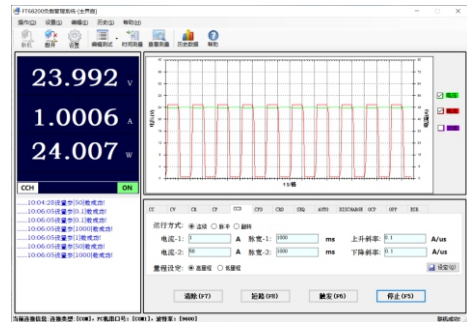
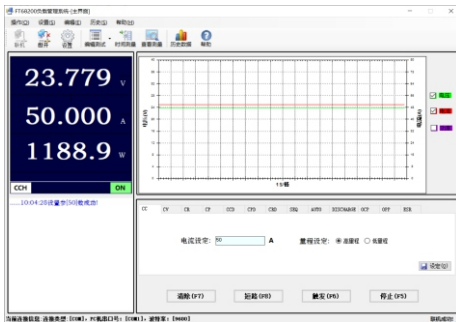

Ordering information

Product series	Power	150V	600V	1200V	1600V	Height
A series	4kW	FT68204A-150-400	FT68204A-600-280	FT68204A-1200-160		4U
	5kW	FT68205A-150-500	FT68205A-600-350	FT68205A-1200-200		4U
	6kW	FT68206A-150-600	FT68206A-600-420	FT68206A-1200-240		4U
	8kW	FT68208A-150-800	FT68208A-600-560	FT68208A-1200-320		7U
	10kW	FT68210A-150-1000	FT68210A-600-700	FT68210A-1200-400		7U
	12kW	FT68212A-150-1200	FT68212A-600-840	FT68212A-1200-480		7U
	18kW	FT68218A-150-1800	FT68218A-600-1260	FT68218A-1200-720		11U
	24kW	FT68224A-150-2400	FT68224A-600-1680	FT68224A-1200-960	FT68224A-1600-480	14U
	30kW	FT68230A-150-2400	FT68230A-600-2100	FT68230A-1200-1200	FT68230A-1600-600	20U
	36kW	FT68236A-150-2400	FT68236A-600-2400	FT68236A-1200-1440	FT68236A-1600-720	20U
	42kW	FT68242A-150-2400	FT68242A-600-2400	FT68242A-1200-1680	FT68242A-1600-840	26U
	48kW	FT68248A-150-2400	FT68248A-600-2400	FT68248A-1200-1920	FT68248A-1600-960	26U
	54kW	FT68254A-150-2400	FT68254A-600-2400	FT68254A-1200-2160	FT68254A-1600-1080	32U
	60kW	FT68260A-150-2400	FT68260A-600-2400	FT68260A-1200-2400	FT68260A-1600-1200	32U
AL series	4kW	FT68204AL-150-240	FT68204AL-600-160	FT68204AL-1200-80		4U
	5kW	FT68205AL-150-300	FT68205AL-600-200	FT68205AL-1200-100		4U
	6kW	FT68206AL-150-360	FT68206AL-600-240	FT68206AL-1200-120		4U
	8kW	FT68208AL-150-480	FT68208AL-600-320	FT68208AL-1200-160		7U
	10kW	FT68210AL-150-600	FT68210AL-600-400	FT68210AL-1200-200		7U
	12kW	FT68212AL-150-720	FT68212AL-600-480	FT68212AL-1200-240		7U
	18kW	FT68218AL-150-1080	FT68218AL-600-720	FT68218AL-1200-360		11U
	24kW	FT68224AL-150-1440	FT68224AL-600-960	FT68224AL-1200-480		14U
	30kW	FT68230AL-150-1800	FT68230AL-600-1200	FT68230AL-1200-600		20U
	36kW	FT68236AL-150-2160	FT68236AL-600-1440	FT68236AL-1200-720		20U
	42kW	--	FT68242AL-600-1680	FT68242AL-1200-840		26U
	48kW	--	FT68248AL-600-1920	FT68248AL-1200-960		26U
	54kW	--	FT68254AL-600-2160	FT68254AL-1200-1080		32U
	60kW	--	--	FT68260AL-1200-1200		32U
E series	4kW	FT68204E-150-400	FT68204E-600-280	FT68204E-1200-80		4U
	5kW	FT68205E-150-500	FT68205E-600-350	FT68205E-1200-100		4U
	6kW	FT68206E-150-600	FT68206E-600-420	FT68206E-1200-120		4U
	8kW	FT68208E-150-800	FT68208E-600-560	FT68208E-1200-160		7U
	10kW	FT68210E-150-1000	FT68210E-600-700	FT68210E-1200-200		7U
	12kW	FT68212E-150-1200	FT68212E-600-840	FT68212E-1200-240		7U
	18kW	FT68218E-150-1800	FT68218E-600-1260	FT68218E-1200-360		11U
	24kW	FT68224E-150-2400	FT68224E-600-1680	FT68224E-1200-960	FT68224E-1600-480	14U
	30kW	FT68230E-150-2400	FT68230E-600-2100	FT68230E-1200-1200	FT68230E-1600-600	20U
	36kW	FT68236E-150-2400	FT68236E-600-2400	FT68236E-1200-1440	FT68236E-1600-720	20U
	42kW	FT68242E-150-2400	FT68242E-600-2400	FT68242E-1200-1680	FT68242E-1600-840	26U
	48kW	FT68248E-150-2400	FT68248E-600-2400	FT68248E-1200-1920	FT68248E-1600-960	26U
	54kW	FT68254E-150-2400	FT68254E-600-2400	FT68254E-1200-2160	FT68254E-1600-1080	32U
	60kW	FT68260E-150-2400	FT68260E-600-2400	FT68260E-1200-2400	FT68260E-1600-1200	32U

Height does not include castor size, more power can be customized

Optional Information

Name	Model or Specification	Instruction
GPIB adapter card	FT68201B	Factory installation before shipment
CAN adapter card	FT68201C	Factory installation before shipment
USB-TMC (optional)	FT68201C	Factory installation before shipment
Parallel machine kit	PC010-682	

* Test cables are optional. For details about specifications and models, see Optional Accessories in this manual.

Specification parameters-1 FT68200A/AL/E series has many models, only some of them are listed for reference.

6kW Models

Model	FT68206A/E-150-600		FT68206A/E-600-420		FT68206AL-1200-120	
Voltage*3	150V		600V		1200V	
Current	600A		420A		120A	
Power*2	6,000W		6,000W		6,000W	
Full current minimum operating voltage	1.5V/600A		8V/420A		20V/120A	
Constant current						
Range	0-60A	0-600A	0-42A	0-420A	0-12A	0-120A
Resolution	1mA	10mA	0.7mA	7mA	0.3mA	2mA
Precision	0.05%+0.05%F.S.		0.05%+0.05%F.S.		0.05%+0.05%F.S.	
Constant voltage						
Range	0-30V	0-150V	0-120V	0-600V	0-240V	0-1200V
Resolution	0.5mV	2.5mV	2mV	10mV	4mV	20mV
Precision	0.025%+0.025%F.S.		0.025%+0.025%F.S.		0.025%+0.025%F.S.	
Constant power *4						
Range	0-6,000W		0-6,000W		0-6,000W	
Resolution	100mW		100mW		100mW	
Precision	0.2%+0.2% F.S.		0.2%+0.2% F.S.		0.2%+0.2% F.S.	
Constant resistance*4						
Range(Ω)	0.009 ~ 50	0.09 ~ 250	0.053 ~ 286	0.53 ~ 1429	0.375 ~ 2000	3.75 ~ 10000
Precision	Vin/Rset*(0.2%)+0.2%IF.S.		Vin/Rset*(0.2%)+0.2%IF.S.		Vin/Rset*(0.2%)+0.2%IF.S.	
Slope						
Current slope(A/us)	0.001 ~ 0.6	0.01 ~ 6	0.0001 ~ 0.4	0.001 ~ 4	0.0001 ~ 0.12	0.001 ~ 1.2
Current measurement						
Range	0-60A	0-600A	0-42A	0-420A	0-12A	0-120A
Resolution	1mA	10mA	0.7mA	7mA	0.2mA	2mA
Precision	0.05%+0.05%F.S.		0.05%+0.05%F.S.		0.05%+0.05%F.S.	
Voltage measurement						
Range	0-30V	0-150V	0-120V	0-600V	0-240V	0-1200V
Resolution	0.5mV	2.5mV	2mV	10mV	4mV	20mV
Precision	0.025%+0.025%F.S.		0.025%+0.025%F.S.		0.025%+0.025%F.S.	
Other specification						
AC voltage	220VAC ±10% , 50 ~ 60Hz , 360VA					
Operating temperature	0 ~ 40°C					
Full power operating temperature	0 ~ 25°C					
Weight	40kg					
Dimension	432mm(W)*177mm(H)*665mm(D)					

Specification parameters-2

FT68200A/AL/E series has many models, only some of them are listed for reference.

12kW Models

Model	FT68212A/E-150-1200		FT68212A/E-600-840		FT68212AL-1200-2400	
Voltage*3	150V		600V		1200V	
Current	1200A		840A		240A	
Power*2	12,000W		12,000W		12,000W	
Full current minimum operating voltage	1.5V/1200A		8V/840A		20V/360A	
Constant current						
Range	0-120A	0-1200A	0-84A	0-840A	0-24A	0-240A
Resolution	2mA	20mA	1.4mA	14mA	0.4mA	4mA
Precision	0.05%+0.05%F.S.		0.05%+0.05%F.S.		0.05%+0.05%F.S.	
Constant voltage						
Range	0-30V	0-150V	0-120V	0-600V	0-240V	0-1200V
Resolution	0.5mV	2.5mV	2mV	10mV	4mV	20mV
Precision	0.025%+0.025%F.S.		0.025%+0.025%F.S.		0.025%+0.025%F.S.	
Constant power*4						
Range	0-12,000W		0-12,000W		0-12,000W	
Resolution	200mW		200mW		200mW	
Precision	0.2%+0.2% F.S.		0.2%+0.2% F.S.		0.2%+0.2% F.S.	
Constant resistance*4						
Range(Ω)	0.005 ~ 25	0.05 ~ 125	0.027 ~ 143	0.27 ~ 714	0.186 ~ 1000	1.86 ~ 5000
Precision	Vin/Rset*(0.2%)+0.2%IF.S.		Vin/Rset*(0.2%)+0.2%IF.S.		Vin/Rset*(0.2%)+0.2%IF.S.	
Slope						
Current slope(A/us)	0.001 ~ 1.2	0.01 ~ 12	0.0001 ~ 0.8	0.001 ~ 8	0.0001 ~ 0.24	0.001 ~ 2.4A
Current measurement						
Range	0-120A	0-1200A	0-84A	0-840A	0-24A	0-240A
Resolution	2mA	20mA	1.4mA	14mA	0.4mA	4mA
Precision	0.05%+0.05%F.S.		0.05%+0.05%F.S.		0.05%+0.05%F.S.	
Voltage measurement						
Range	0-30V	0-150V	0-120V	0-600V	0-240V	0-1200V
Resolution	0.5mV	2.5mV	2mV	10mV	4mV	20mV
Precision	0.025%+0.025%F.S.		0.025%+0.025%F.S.		0.025%+0.025%F.S.	
Other specification						
AC voltage	220VAC ±10% , 50 ~ 60Hz , 720VA					
Operating	0 ~ 40°C					
Full power operating temperature	0 ~ 25°C					
Weight	72kg					
Dimension	432mm(W)*385mm(H)*715mm(D) (Caster included)					

Specification parameters-3 FT8200A/AL/E series has many models, only some of them are listed for reference.

24kW Models

Model	FT68224A/E-150-2400	FT68224A/E-600-1680	FT68224AL-1200-480	FT68224A/E-1600-480				
Voltage*3	150V	600V	1200V	1600V				
Current	2400A	1680A	480A	480A				
Power*2	24,000W	24,000W	24,000W	24,000W				
Full current minimum operating voltage	1.5V/2400A	8V/1680A	20V/480A	30V/480A				
Constant current								
Range	0-240A	0-2400A	0-168A	0-1680A	0-48A	0-480A	0-48A	0-480A
Resolution	4mA	40mA	2.8mA	28mA	0.8mA	8mA	0.8mA	8mA
Precision	0.05%+0.05%F.S.		0.05%+0.05%F.S.		0.05%+0.05%F.S.		0.05%+0.05%F.S.	
Constant voltage								
Range	0-30V	0-150V	0-120V	0-600V	0-240V	0-1200V	0-320V	0-1600V
Resolution	0.5mV	2.5mV	2mV	10mV	4mV	20mV	5.3mV	27mV
Precision	0.025%+0.025%F.S.		0.025%+0.025%F.S.		0.025%+0.025%F.S.		0.025%+0.025%F.S.	
Constant power*4								
Range	0-24,000W		0-24,000W		0-24,000W		0-24,000W	
Resolution	400mW		400mW		400mW		400mW	
Precision	0.2%+0.2% F.S.		0.2%+0.2% F.S.		0.2%+0.2% F.S.		0.2%+0.2% F.S.	
Constant resistance*4								
Range(Ω)	0.002 ~ 13	0.02 ~ 63	0.013 ~ 71	0.13 ~ 357	0.093 ~ 500	0.93 ~ 2500	0.125 ~ 666	1.25 ~ 3330
Precision	Vin/Rset*(0.2%)+0.2%IF.S.							
Slope								
Current slope(A/us)	0.001 ~ 2.4	0.001 ~ 24	0.001 ~ 1.6	0.001 ~ 16	0.001 ~ 0.48	0.001 ~ 4.8	0.001 ~ 0.48	0.001 ~ 4.8
Current measurement								
Range	0-240A	0-2400A	0-168A	0-1680A	0-72A	0-720A	0-72A	0-720A
Resolution	4mA	40mA	2.8mA	28mA	1.2mA	12mA	1.2mA	12mA
Precision	0.05%+0.05%F.S.		0.05%+0.05%F.S.		0.05%+0.05%F.S.		0.05%+0.05%F.S.	
Voltage measurement								
Range	0-30V	0-150V	0-120V	0-600V	0-240V	0-1200V	0-320V	0-1600V
Resolution	0.5mV	2.5mV	2mV	10mV	4mV	20mV	5.3mV	27mV
Precision	0.025%+0.025%F.S.		0.025%+0.025%F.S.		0.025%+0.025%F.S.		0.025%+0.025%F.S.	
Other specification								
AC voltage	220VAC ±10% , 50 ~ 60Hz , 1420VA							
Operating temperature	0 ~ 40°C							
Full power operating temperature	0 ~ 25°C							
Weight	156kg							
Dimension	432mm(W)*695mm(H)*714mm(D)(includes casters)							

* All specifications are subject to change without notice.

*1. The above accuracy parameters are measured in the temperature range of 25±5°C.

*2. The rated power specification is allowed at ambient temperature of 25°C.

*3. If the operating voltage exceeds 1.05 times the rated voltage, it will cause permanent damage to the device.

*4. The input value of voltage and current shall not be less than 5%F.S.

*5. For the voltage class of 1200V model, the relationship between its rated input power and input voltage is shown in the following figure:

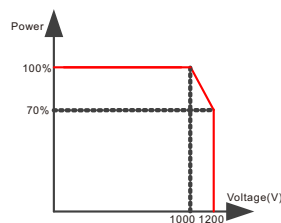

A / AL / E Function configuration list

Function list	A	AL	E
Constant current(CCH/CCL)	P	P	P
Constant voltage(CVH/CVL)	P	P	P
Constant resistance(CR)	P	P	P
Constant power(CP)	P	P	P
Dynamic current(CCDH/CCDL)	P	P	P
Dynamic resistance(CRD)	P	P	O
Dynamic power(CPD)	P	P	O
Sequence(SEQ)	P	P	P
Auto	P	P	P
Over current protection	P	P	P
Over power protection	P	P	P
Discharge	P	P	P
Load effect	P	P	P
Discharge resistance	P	P	P
LED simulation (LED)	P	P	O
Dynamic scanning (SWEEP)	P	P	P
MPPT	P	P	O
CC+CV	P	P	O
CR+CV	P	P	O
CV+CC	P	P	O
CR+CC	P	P	O
CP+CC	P	P	O
Save&Recall	P	P	P
Remote compensation	P	P	P
Constant voltage velocity	P	P	P
Simulation programming	P	P	P
External control	P	P	P
Simulation short	P	P	P
Timed load	P	P	P
VON/VOFF	P	P	P
Limit set	P	P	P
Hardware limitation	P	P	P
Time measurement	P	P	P
Vpk+/-	P	P	P
Data transmission	1kHz/s	1kHz/s	1kHz/s
Parallel operation	P	P	P
communication	RS232/RS485/LAN/USB (GPIB,CAN assorting)		

Dimension drawing

4U model (4kW、6kW) Dimension Drawing

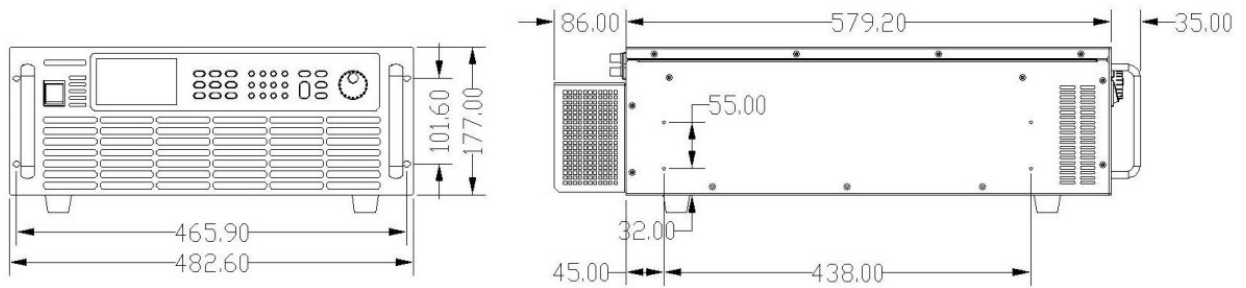

4U model (7kW~12kW) Dimension Drawing

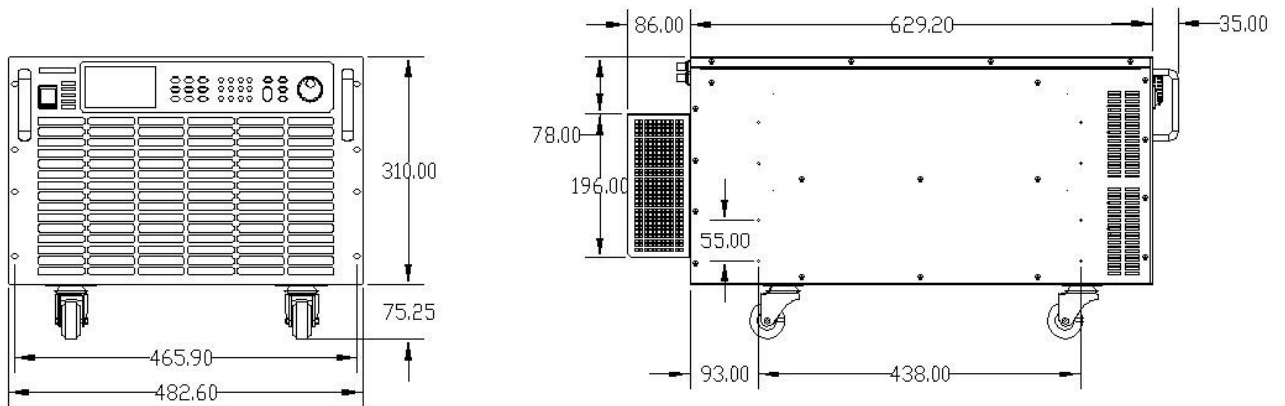

4U model (20kW~24kW) Dimension Drawing

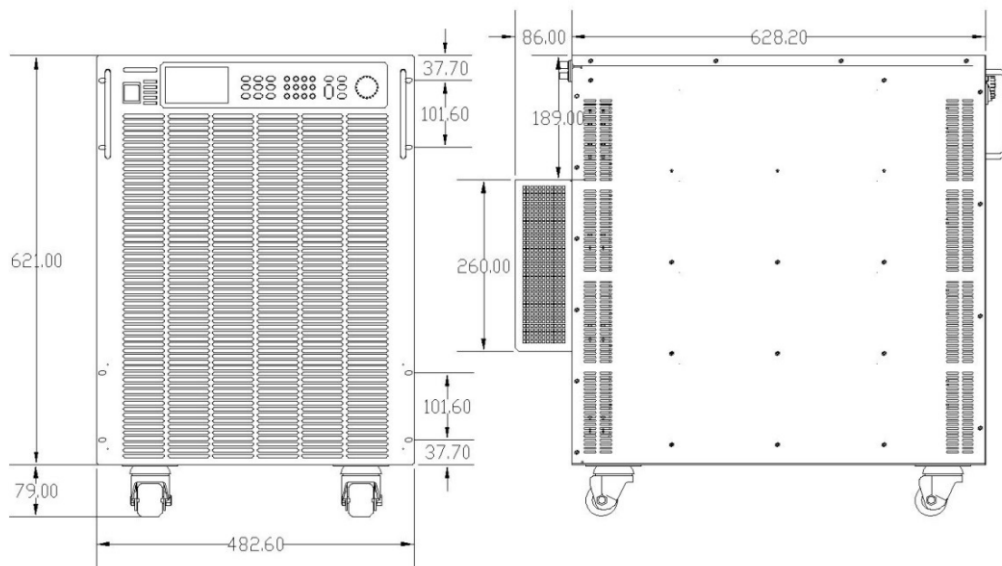

Distribution in the UK & Ireland



Lambda Photometrics Limited
Lambda House Batford Mill
Harpenden Herts AL5 5BZ
United Kingdom
E: info@lambdaphoto.co.uk
W: www.lambdaphoto.co.uk
T: +44 (0)1582 764334
F: +44 (0)1582 712084