



# SPECTRUM ANALYZER QUICK START GUIDE

Distribution in the UK & Ireland



**Lambda Photometrics Limited**  
Lambda House Batford Mill  
Harpenden Herts AL5 5BZ  
United Kingdom  
E: [info@lambdaphoto.co.uk](mailto:info@lambdaphoto.co.uk)  
W: [www.lambdaphoto.co.uk](http://www.lambdaphoto.co.uk)  
T: +44 (0)1582 764334  
F: +44 (0)1582 712084



# SPECTRUM ANALYZER QUICK START GUIDE

Real-time Spectrum Analyzer  
up to 40 GHz

V1.2  
11/10/2025



# CONTENTS

|   |           |
|---|-----------|
| <b>1. Version Management</b> .....              | <b>1</b>  |
| <b>2. System requirements</b> .....             | <b>2</b>  |
| <b>3. SA Series Quick Start Guide</b> .....     | <b>3</b>  |
| 3.1 Safety Instruction .....                    | 3         |
| 3.1.1 Power Adapter Selection .....             | 3         |
| 3.1.2 RF Input .....                            | 3         |
| 3.2 Using SA Series Instruments.....            | 3         |
| 3.2.1 Connecting the Device .....               | 3         |
| 3.2.2 Driver Installation (Windows).....        | 3         |
| 3.2.3 Driver Installation (Linux) .....         | 4         |
| 3.3 Running the Software .....                  | 4         |
| 3.4 External Interface Description.....         | 5         |
| 3.4.1 SAN Series and SAM Series.....            | 5         |
| 3.4.2 SAE Series and SAN-400 Series.....        | 6         |
| <b>4. NX Series Quick Start Guide</b> .....     | <b>8</b>  |
| 4.1 Safety Instructions .....                   | 8         |
| 4.1.1 Power Adapter Selection .....             | 8         |
| 4.1.2 RF Input .....                            | 8         |
| 4.2 Using the NX Series Device .....            | 8         |
| 4.2.1 Connecting the Device .....               | 8         |
| 4.2.2 Configuring the Network.....              | 9         |
| 4.3 Running the Software .....                  | 9         |
| 4.4 External Interface Description.....         | 10        |
| 4.4.1 NXN and NXM Series .....                  | 10        |
| 4.4.2 NXE Series and NXN-400 .....              | 12        |
| <b>5. PX Series Quick Start Guide</b> .....     | <b>14</b> |
| 5.1 Safety Instruction .....                    | 14        |
| 5.1.1 Safety Rules.....                         | 14        |
| 5.1.2 Power Adapter Selection.....              | 14        |
| 5.1.3 RF Input .....                            | 14        |
| 5.1.4 Replacing the Power Adapter .....         | 14        |
| 5.2 First Use of the Instrument .....           | 14        |
| 5.2.1 Switching the Instrument On and Off ..... | 15        |
| 5.2.2 Charging Indicator .....                  | 15        |
| 5.2.3 Running the Software .....                | 15        |
| 5.3 External Interface Description.....         | 15        |
| 5.3.1 PX Series .....                           | 15        |
| 5.3.2 PXZ Series .....                          | 17        |

|   |           |
|---|-----------|
| <b>6. GNSS Application Instructions</b> .....                     | <b>19</b> |
| 6.1 Version Information .....                                     | 19        |
| 6.2 GNSS Options.....   | 19        |
| 6.2.1 Options Overview .....                                      | 19        |
| 6.2.2 Interface Description.....                                  | 21        |
| 6.3 Connection of Internal GNSS Module (Version A) .....          | 22        |
| 6.3.1 SAE/SAN-400 Series .....                                    | 22        |
| 6.3.2 SAM/SAN Series .....  | 22        |
| 6.3.3 NX Series.....  | 23        |
| 6.3.4 PX Series.....  | 23        |
| 6.3.5 PXZ Series .....  | 23        |
| 6.4 Connection of Internal GNSS Module (Version B) .....          | 23        |
| 6.4.1 SAE/SAN-400 Series .....                                    | 23        |
| 6.4.2 SAM/SAN Series .....  | 24        |
| 6.4.3 NX Series.....  | 24        |
| 6.4.4 PX Series.....  | 24        |
| 6.4.5 PXZ Series .....  | 25        |
| 6.5 Connection of External GNSS Module .....                      | 25        |
| <b>7. Analogue IF output</b> .....                                | <b>26</b> |
| 7.1 Output Intermediate Frequency Signal .....                    | 26        |
| 7.2 Viewing the Intermediate Frequency Signal.....                | 26        |
| <b>8. Modify the IP address of the NX-Series instrument</b> ..... | <b>28</b> |
| 8.1 Obtaining NX-Series Instrument IP Addresses .....             | 28        |
| 8.2 Modifying NX-Series Instrument IP Addresses .....             | 28        |
| 8.2.1 Notes on IP modification .....                              | 28        |
| 8.2.2 IP Modification Procedure.....                              | 28        |
| <b>9. PX Remote Control Guide</b> .....                           | <b>30</b> |
| 9.1 Network port direct connection .....                          | 30        |
| 9.2 LAN connectivity.....   | 32        |
| 9.3 OTG Connection .....  | 33        |

# 1. Version Management

Version Update Description Table

| <b>Version</b> | <b>Content</b>  | <b>Date</b> |
|----------------|---|-------------|
| <b>V1.2</b>    | <ol style="list-style-type: none"><li>1. Modified: Renamed MUXIO to AUXIO</li><li>2. Modified: Description modification</li></ol>   | 11/10/2025  |
| <b>V1.1</b>    | <ol style="list-style-type: none"><li>1. Added: Added a GNSS version description section, distinguishing the connection steps for the old and new GNSS modules</li><li>2. Added: Added a section on outputting and viewing the simulated intermediate frequency (IF) signal</li><li>3. Added: Added: a section on OTG connection</li></ol>                | 09/04/2025  |
| <b>V1.0</b>    | <ol style="list-style-type: none"><li>1. Added: Added quick start guide and interface functions for spectrum analyzer</li><li>2. Added: Added GNSS user manual</li><li>3. Added: Added analog IF output support</li><li>4. Added: Added IP address modification guide for NX series instruments</li><li>5. Added: Added PX remote control guide</li></ol> | 07/30/2025  |

# 2. System requirements

SA/NX series are core instruments, and their spectrum analysis software must be installed on a host computer. The recommended host system requirements are listed in the table below: The table provides only basic recommended configurations. For systems below these specifications, please verify with actual test results.

**Table 1 System Requirements**

|                         |   |
|-------------------------|---|
| <b>Operating System</b> | Windows 11/10/8/7, (requires VS2019 C++ redistributables)<br>Ubuntu 22.04/20.04/18.04, Debian 12/11/10, Raspberry Pi OS 64bit     |
| <b>Architecture</b>     | Windows: x64, AArch64 (NX instruments only)<br>Linux: x64, AArch64  |
| <b>Processor</b>        | Windows: Intel i3 or higher; AArch64 tested only on Snapdragon 8CX Gen2<br>Linux: Tested on Raspberry Pi 4B, PK3399, PK3588, etc. |
| <b>Memory</b>           | 4 GB or higher  |
| <b>Storage</b>          | For IQ signal recording: Ensure sustained write speeds exceed 400 MBytes/s  |
| <b>Data Interface</b>   | USB 2.0 or USB 3.0 (USB 3.0 recommended)<br>IQ recording bandwidth and duration are limited by interface bandwidth                |
| <b>Display</b>          | Minimum resolution: 1280×800 pixels   |
| <b>Other Notes</b>      | Some antivirus software may cause system instability  |

## 3. SA Series Quick Start Guide

This chapter is a quick start guide to the SA Series, featuring safety instruction, using instruments, running the software and external interface description.

### 3.1 Safety Instruction

#### 3.1.1 Power Adapter Selection

1. Adapter Option: Always use the original manufacturer-provided power adapter. Alternative: If unavailable, select a compatible adapter with specifications matching those outlined in the product manual.
2. DC power supply requirements: voltage:  $5\text{ V} \pm 0.25\text{ V}$  (4.75 V to 5.25 V), current: minimum 2 A; peak ripple maximum 200 mVpp.

⚠️ Violation of specifications may result in damage to the instrument, follow the product manual strictly.

#### 3.1.2 RF Input

For maximum damage input power (CW) and maximum DC voltage, please refer to the product manual, and strictly prohibit exceeding the limits to avoid irreversible damage to the instrument.

### 3.2 Using SA Series Instruments

#### 3.2.1 Connecting the Device

1. Connect the instrument's [power port](#) to the power adapter using the Type-C cable and plug it into the socket;
2. Connect the instrument's [data port](#) to a computer or embedded device using a Type-C cable, USB 3.0 is recommended for best performance.

**Important note: It requires for 3 seconds for SA Series instruments operating normally after power-on.**



Figure 1 SA series connection diagram

#### 3.2.2 Driver Installation (Windows)

The following part presents the instructions for driver installation using Windows 10 x64 as an example. Note: Windows 11 is compatible with Windows 10 drivers.

1. Check the computer system information, confirm the system version and number of bits;

2. Open the "Windows\HTRA\_Driver\Win10\_x64" folder in the supplied USB flash;
3. Right-click the "Install\_Driver.bat" file and select "Run as administrator" from the pop-up menu to initiate driver installation;

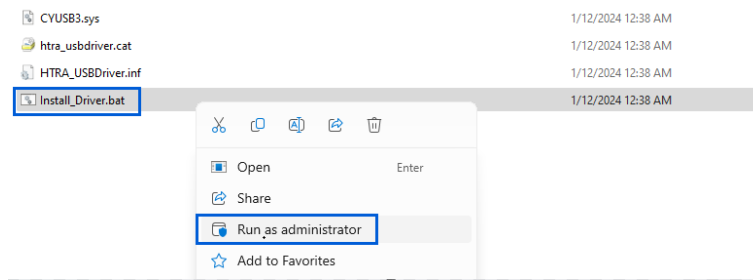

Figure 2 Installation of driver

4. The terminal appears "USB Driver Installation Succeeded" prompt, it means that the driver installation success.

### 3.2.3 Driver Installation (Linux)

The following will be an example of installing the driver in Ubuntu 18.04.

1. Copy the "Linux" folder from the supplied USB flash to the system;
2. Right-click on the "Linux/Install\_HTRA\_SDK" folder and select "Open in Terminal" to open the terminal;
3. In the terminal type `sudo sh install_htraapi_lib.sh` and enter, according to the prompts to enter the current user password, and then enter again to confirm the installation;
4. After connecting the instrument, type `lsusb` in the terminal, such as ID:6430, ID:3675, ID:04b5 or ID:367f, it means the driver installation is successful.

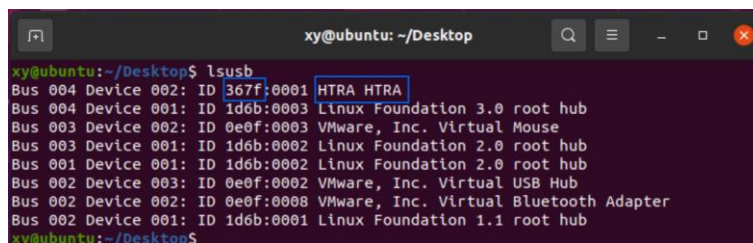

Figure 3 Linux to see if the instrument is properly connected

### 3.3 Running the Software

By default, the instrument is properly connected and the driver is installed.

1. Copy the software folder in the "Windows" directory of the supplied USB flash drive to the desktop or other directories of your computer;
2. Enter the "\bin" folder in the software directory, run the executable program, and the spectrum display interface will be as follows.

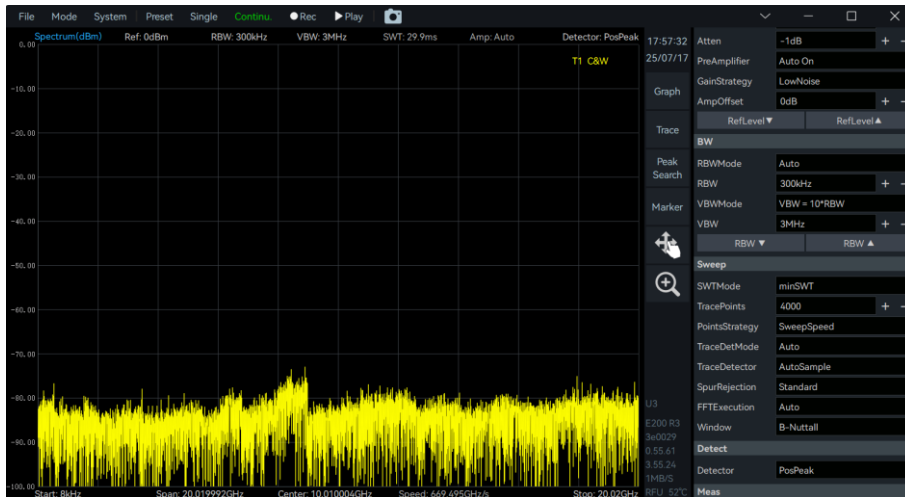

Figure 4 Initial software display

### 3.4 External Interface Description

#### 3.4.1 SAN Series and SAM Series

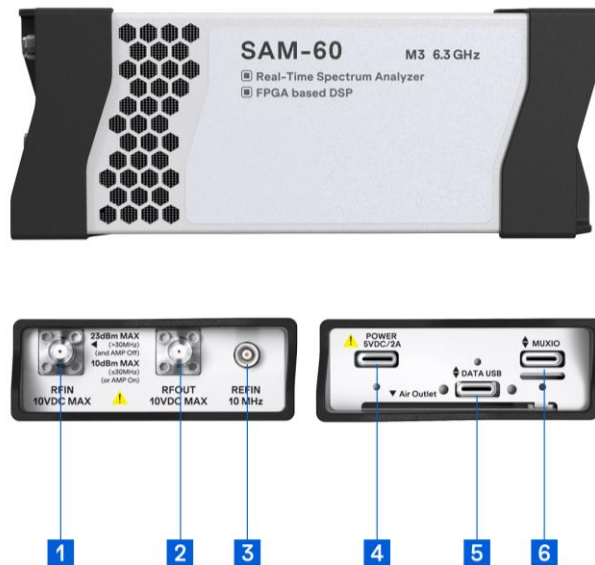

Figure 5 SAN and SAM Series Instrument Interface Description

Table 2 SAN Series and SAM Series Interface Description

| Pin | Interface Name        | Description  |
|-----|-----------------------|--|
| 1   | RF Input              | SMA (F), Input Impedance 50 Ω  |
| 2   | RF Output             | SMA (F), Output Impedance 50 Ω (Available with "Built-in Signal Source" option)    |
| 3   | Reference Clock Input | MCX (F), Amplitude ≥ 1.5 Vpp, Input Impedance 330 Ω.                               |
| 4   | Power Port            | Supports Sine, Square, Peak Clipping Sine Instrument Charging Port, Type-C 5 V 2 A |
| 5   | Data Port             | Type-C, USB 3.0 Recommended (USB 2.0 compatible, but bandwidth limited)            |
| 6   | Multifunctional AUXIO | For a detailed description, please refer to Table 3.                               |

**Table 3 Description of Multi-function AUXIO PIN Interface of Port 6 (Illustration direction from left to right)**

| Pin | Name          | Direction | Level Standard | Meaning                                    |
|-----|---------------|-----------|----------------|--|
| A1  | GND           | /         | /              | Ground                                     |
| A2  | NC            | /         | /              | /  |
| A3  | EXT_TRG-IO1_F | I         | 3.3 V          | External trigger input, up to 500 times/s. |
| A4  | VEXT          | O         | /              | Power Output, 5 V                          |
| A5  | GND           | /         | /              | Ground                                     |
| A6  | USART6_TX_F   | /         | /              | /  |
| A7  | USART6_RX_F   | /         | /              | /  |
| A8  | NC            | /         | /              | /  |
| A9  | VEXT          | O         | /              | Power Output, 5 V                          |
| A10 | EXT_TRG-IO2_F | O         | 3.3 V          | External trigger output                    |
| A11 | USART6_IT_F   | /         | /              | Reserved                                   |
| A12 | GND           | /         | /              | Ground                                     |

### 3.4.2 SAE Series and SAN-400 Series

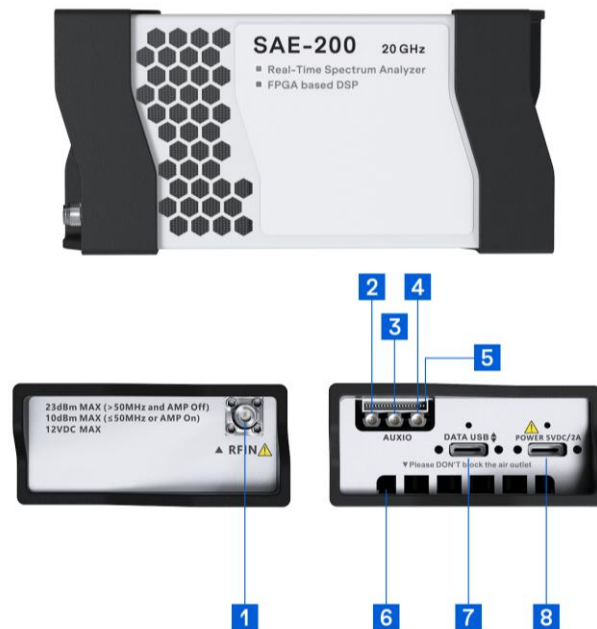

Figure 6 SAE and SAN-400 series instrument interface description

**Table 4 SAE Series and SAN-400 Interface**

| Pin | Interface Name        | Description   |
|-----|-----------------------|---|
| 1   | RF Signal Input       | SAE-90 series instruments: SMA (F), input impedance 50 Ω<br>SAE-200/SAN-400 series instruments: 2.92 mm (F), input impedance 50 Ω |
| 2   | Analogue IF output    | MMCX (F), maximum output power -25 dBm, output impedance 50 Ω   |
| 3   | Reserved interface    | /   |
| 4   | Reference Clock Input | MMCX (F), Amplitude ≥ 1.5 Vpp, Input Impedance 330 Ω<br>Supports Sine, Square, Peak Clipping Sine                                 |
| 5   | Multifunctional AUXIO | For a detailed description, please refer to Table 5.  |
| 6   | Heat dissipation vent | /   |
| 7   | Data port             | Type-C, USB 3.0 Recommended (USB 2.0 compatible, but bandwidth limited)   |
| 8   | Power port            | Instrument Charging Port, Type-C 5 V 2 A  |

**Table 5 Description of Multifunctional AUXIO PIN Interface of Port 5 (Illustration direction from left to right)**

| Pin | Name        | Direction | Level Standard | Meaning   |
|-----|-------------|-----------|----------------|---|
| 1   | EXT_TRG_IO1 | I         | 3.3 V          | Trigger input, up to 500 times/s                                |
| 2   | EXT_TRG_IO2 | /         | /              | Reserved  |
| 3   | EXT_TRG_IO3 | O         | 3.3 V          | Trigger output  |
| 4   | GND         | /         | /              | Ground  |
| 5   | LFADC_INA   | I         | /              | Low Frequency ADC Input   |
| 6   | 3V3D        | O         | /              | Power output, 3.3 V Output                                      |
| 7   | USART9_RX   | /         | /              | /   |
| 8   | GND         | /         | /              | Ground  |
| 9   | USART_TX    | /         | /              | /   |
| 10  | NC          | /         | /              | /   |
| 11  | NC          | /         | /              | /   |
| 12  | NC          | /         | /              | /   |
| 13  | GND         | /         | /              | Ground  |
| 14  | REFCLK_OUT  | O         | /              | Reference clock output, can output 10 MHz standard clock signal |

## 4. NX Series Quick Start Guide

This chapter is a quick start guide to the NX Series, featuring safety instructions, instrument use, runtime software and external interface descriptions.

### 4.1 Safety Instructions

#### 4.1.1 Power Adapter Selection

1. Primary Option: Always use the original manufacturer-provided power adapter. Alternative: If unavailable, select a compatible adapter with specifications matching those outlined in the product manual.
2. DC power supply requirements: voltage: 12 V (9 V to 12 V), current: minimum 2 A; peak ripple maximum 200 mVpp.

⚠️ Violation of specifications may result in damage to the instrument, follow the product manual strictly.

#### 4.1.2 RF Input

For maximum damage input power (CW) and maximum DC voltage, please refer to the product manual, and strictly prohibit exceeding the limits to avoid irreversible damage to the instrument.

### 4.2 Using the NX Series Device

#### 4.2.1 Connecting the Device

1. Connect the instrument's [power port](#) to the power adapter using the Type-C cable and plug it into the socket.
2. Use a network cable to connect the Gigabit network port (LAN2) of the instrument to the network port of the computer or embedded device for optimal performance (100 Mbps for [LAN1](#) and 1 Gbps for [LAN2](#)).

Note: NX series instruments need about 40 s to complete the self-start after power on, please wait patiently. Long press the power button for more than 5 seconds to switch off the instrument.



Figure 7 NX series connection diagram

## 4.2.2 Configuring the Network

NX Series Instrument Network Configuration Instructions:

- IPv4 address: "192.168.1.100" (not modifiable), "192.168.3.100" (modifiable)
- Subnet mask: "255.255.255.0"
- Bridge mode: enabled (LAN1/LAN2 logical interworking)
- Network access: via [LAN1](#) (100 Mbps) or [LAN2](#) (1 Gbps)

The host computer needs to set the IP of the same network segment as the NX instrument (e.g. "192.168.1.X" or "192.168.3.X") in order to be used normally, and the IP address of the host computer can be configured as follows:

1. Open "Settings" -> select "Network & Internet" -> select "Ethernet";
2. Enter Ethernet, find the IP section and click "Edit";
3. Select "Manual" mode and enable "IPv4", set the IP to "192.168.1.2" and the subnet mask to "255.255.255.0". Set the IP to "192.168.1.2" and subnet mask to "255.255.255.0";
4. Open the command prompt (Win + R -> enter "cmd"), the implementation of the command "ping 192.168.1.100", if you receive the following reply, it means that the network connection is successful.

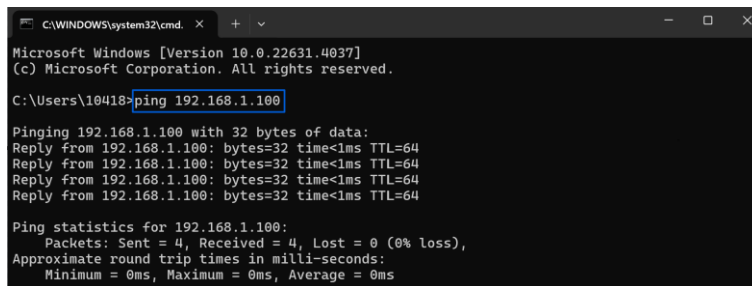

```
C:\WINDOWS\system32\cmd. x + v
Microsoft Windows [Version 10.0.22631.4037]
(c) Microsoft Corporation. All rights reserved.
C:\Users\10418>ping 192.168.1.100
Pinging 192.168.1.100 with 32 bytes of data:
Reply from 192.168.1.100: bytes=32 time<1ms TTL=64
Reply from 192.168.1.100: bytes=32 time<1ms TTL=64
Reply from 192.168.1.100: bytes=32 time<1ms TTL=64
Reply from 192.168.1.100: bytes=32 time<1ms TTL=64
Ping statistics for 192.168.1.100:
    Packets: Sent = 4, Received = 4, Lost = 0 (0% loss),
    Approximate round trip times in milli-seconds:
        Minimum = 0ms, Maximum = 0ms, Average = 0ms
```

Figure 8 Test instrument network connectivity (ping command)

## 4.3 Running the Software

The default instrument is properly connected and the network is successfully configured according to the above sections.

1. Copy the software folder in the Windows directory of the supplied USB flash drive to the desktop or other directory of your computer;
2. Enter the "\bin" folder in the software directory, run the executable program, and the spectrum display interface will be as follows.

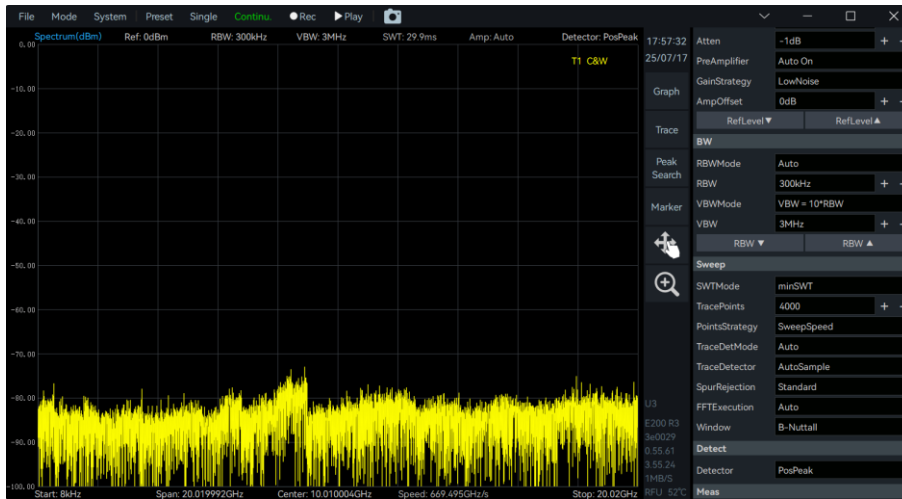

Figure 9 Initial software display

## 4.4 External Interface Description

### 4.4.1 NXN and NXM Series

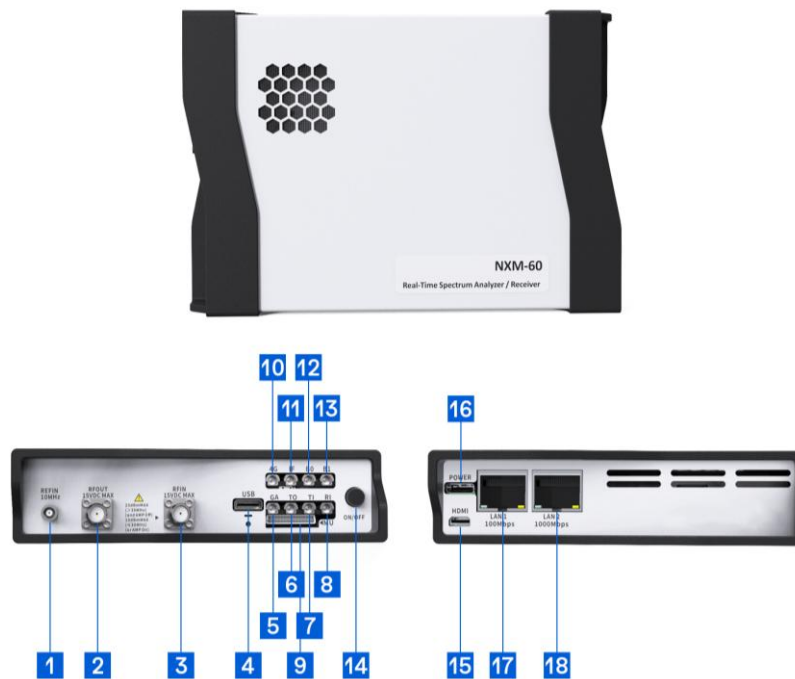

Figure 10 NXN and NXM Series Instrument Interface Description

Table 6 NXN Series and NXM Series Interface Description

| Pin | Interface Name        | Description   |
|-----|-----------------------|---|
| 1   | Reference Clock Input | MCX (F), Amplitude $\geq 1.5$ Vpp, Input Impedance 330 $\Omega$ . Supports Sine, Square, Peak Clipping Sine |
| 2   | RF Output             | SMA (F), Output Impedance 50 $\Omega$ (Available with "Built-in Signal Source" option)                      |
| 3   | RF Input              | SMA (F), input impedance 50 $\Omega$  |
| 4   | USB                   | Type-C, USB 2.0   |

|          |                        |  |
|----------|------------------------|--|
| 5        | GNSS antenna input     | MMCX (F)   |
| 6        | Trigger output         | MMCX (F), 3.3V CMOS  |
| 7        | Trigger input          | MMCX (F), 3.3V CMOS, high-impedance input, max trigger rate 500 times/s  |
| 8        | Reference Clock Output | Provides high quality 10 MHz clock signal when equipped with internal DOCXO  |
| 11 12 13 | Reserved Interface     | /  |
| 9        | Multifunctional AUXIO  | For a detailed description, please refer to Table 7.   |
| 10       | 4G Antenna Input       | MMCX (F)   |
| 14       | Instrument Switch      | Switch the instrument on/off. The instrument starts up automatically on first power-up, eliminating the need to manually press the switch. During power-up, the instrument can be switched off and on again with a switch. |
| 15       | Reserved Interface     | /  |
| 16       | Power Port             | Type-C PD3.0 12 V 2 A/9 V 2 A  |
| 17       | LAN1                   | Fast Ethernet Port (100 Mbps)  |
| 18       | LAN2                   | Fast Ethernet Port (1 Gbps)  |

**Table 7 Description of Multifunctional AUXIO PIN Interface of Port 9 (Illustration direction from right to left)**

| Pin      | Name          | Direction | Level Standard | Meaning   |
|----------|---------------|-----------|----------------|---|
| 1        | GPIO0         | /         | /              | Reserved  |
| 2        | TRG IO2       | /         | /              | Reserved  |
| 3        | GPIO1         | /         | /              | Reserved  |
| 4        | GND           | /         | /              | Ground  |
| 5        | GPIO2         | /         | /              | Reserved  |
| 6        | 3V3/5VIN      | O         | /              | Power output, 5 V output                          |
| 7        | GPIO3         | /         | /              | Reserved  |
| 8        | GND           | /         | /              | Ground  |
| 9        | USART_TX_FP   | /         | /              | Reserved  |
| 10 11 12 | NC            | /         | /              | /   |
| 13       | GND           | /         | /              | Ground  |
| 14       | REFCLK_OUT_FP | O         | /              | Reference Clock Output, Outputs 10 MHz std. clock |

#### 4.4.2 NXE Series and NXN-400

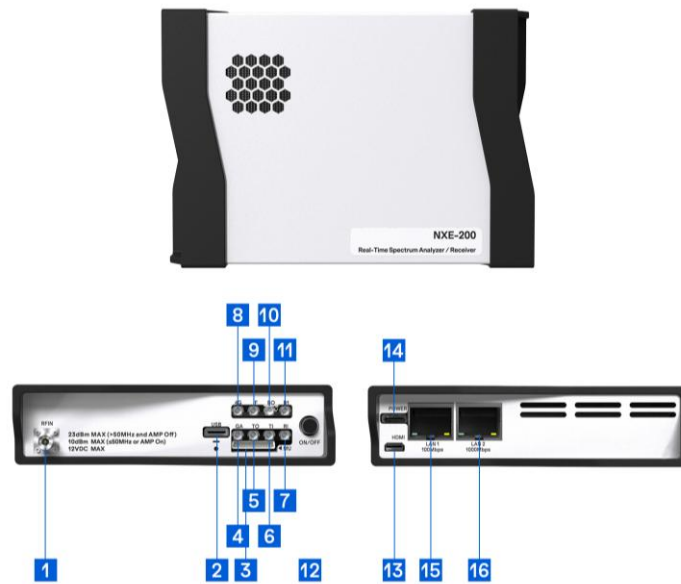

Figure 11 NXE and NXN-400 series instrument interface description

**Table 8 NXE and NXN-400 Series Interface Description**

| Pin    | Interface Name          | Description  |
|--------|-------------------------|--|
| 1      | RF Input                | NXE-90 series instruments: SMA (F), input impedance 50 Ω<br>NXE-200/NXN-400 series instruments: 2.92 mm (F), input impedance 50 Ω  |
| 2      | USB                     | Type-C, USB 2.0  |
| 3      | Multifunctional AUXIO   | For a detailed description, please refer to Table 9.   |
| 4      | GNSS Antenna Input      | MMCX (F)   |
| 5      | Trigger Output          | MMCX (F), 3.3V CMOS  |
| 6      | Trigger Input           | MMCX (F), 3.3V CMOS, high-impedance input, max trigger rate 500 times/s  |
| 7      | Reference Clock Input   | MMCX (F), Amplitude $\geq 1.5$ Vpp, Input Impedance 330 Ω. Supports Sine, Square, Peak Clipping Sine   |
| 8      | 4G Antenna Input        | MMCX (F)   |
| 9      | Analog IF Output        | MMCX (F), Max Output Power -25 dBm, Output Impedance 50 Ω  |
| 10, 11 | Reserved Interface      | /  |
| 12     | Instrument Power Switch | Switch the instrument on/off. The instrument starts up automatically on first power-up, eliminating the need to manually press the switch. During power-up, the instrument can be switched off and on again with a switch. |
| 13     | Reserved Interface      | /  |
| 14     | Power Port              | Type-C PD 3.0 12 V 2 A/9 V 2 A   |
| 15     | LAN1                    | Fast Ethernet Port (100 Mbps)  |
| 16     | LAN2                    | Fast Ethernet Port (1 Gbps)  |

**Table 9 Pin 3 Multi-function AUXIO Pin out Description (Pins ordered right-to-left in diagram)**

| Pin | Name          | Direction | Level Standard | Meaning   |
|-----|---------------|-----------|----------------|---|
| 1   | GPIO0         | /         | /              | Reserved  |
| 2   | TRG IO2       | /         | /              | Reserved  |
| 3   | GPIO1         | /         | /              | Reserved  |
| 4   | GND           | /         | /              | Ground  |
| 5   | GPIO2         | /         | /              | Reserved  |
| 6   | 3V3/5VIN      | O         | /              | Power Output, 3.3V Output                         |
| 7   | GPIO3         | /         | /              | Reserved  |
| 8   | GND           | /         | /              | Ground  |
| 9   | USART_TX_FP   | /         | /              | Reserved  |
| 10  | SYNC_RXRFLO   | /         | /              | Reserved  |
| 11  | SYNC_ADCCLK   | /         | /              | Reserved  |
| 12  | SYNC_RXIFLO   | /         | /              | Reserved  |
| 13  | GND           | /         | /              | Ground  |
| 14  | REFCLK_OUT_FP | O         | /              | Reference Clock Output, Outputs 10 MHz std. clock |

# 5. PX Series Quick Start Guide

This chapter is a quick start guide to the PX Series, featuring safety instructions, instrument use and external interface descriptions.

## 5.1 Safety Instruction

### 5.1.1 Safety Rules

- Appearance check: make sure that the instrument is in good condition and free from damages
- Accessory check: no damage to power cord, adapter
- Ventilation check: fan vents are kept clear
- Environment check: the instrument is dry and free of moisture and condensation, and the ambient temperature meets the requirements of the product specification
- Operation monitoring: Ensure that the fan is working properly and that the working temperature and humidity are in accordance with the product specifications
- Connection specification: all external interfaces are correctly connected and the RF input signal level meets the requirements of the product specification
- Power management: maintains battery at >5% of capacity
- Storage requirements: the instrument is completely switched off, and the temperature and humidity of the storage environment meets the requirements of the product specification
- ⚠ Abnormal handling: Any damage or malfunction is found, please contact the official after-sales service in a timely manner
- ⚠ Safety warning: It is strictly forbidden to open the shell of the instrument (to prevent electric shock)

### 5.1.2 Power Adapter Selection

Adapter Selection: Prefer the original matching power adapter. Alternative: Refer to the product manual to select the adapter with matching specifications.

- ⚠ PXZ instruments must use the original factory-mounted power adapter; third-party alternatives are not supported.
- ⚠ Violation of specifications may result in damage to the instrument, follow the product manual strictly.

### 5.1.3 RF Input

For maximum damage input power (CW) and maximum DC voltage, please refer to the product manual, and strictly prohibit exceeding the limits to avoid irreversible damage to the instrument.

### 5.1.4 Replacing the Power Adapter

PX series instruments support the replacement of batteries, if you need to replace, please contact the official after-sales service channel to deal with, do not disassemble the instrument.

## 5.2 First Use of the Instrument

The instrument has been transported over a long distance, the battery power may be below 5%, it is recommended to connect the supplied power adapter before the first use, and then switch on the instrument.

### 5.2.1 Switching the Instrument On and Off

The instrument is switched on/off by the [power button](#) on the top of the instrument. When the instrument is switched on, the power indicator light is on; when it is switched off, the power indicator light is off.

### 5.2.2 Charging Indicator

When the instrument is connected to the power adapter, the charging status light flashes green to indicate that it is charging. When the battery is fully charged, the charging indicator light will change to a green constant light.

### 5.2.3 Running the Software

Press the power button, the instrument will enter the desktop environment after powering on and start the software automatically.

## 5.3 External Interface Description

### 5.3.1 PX Series

All interfaces of the instrument are integrated in the top panel for user-friendly operation, please refer to Table 10 for detailed description of each interface.

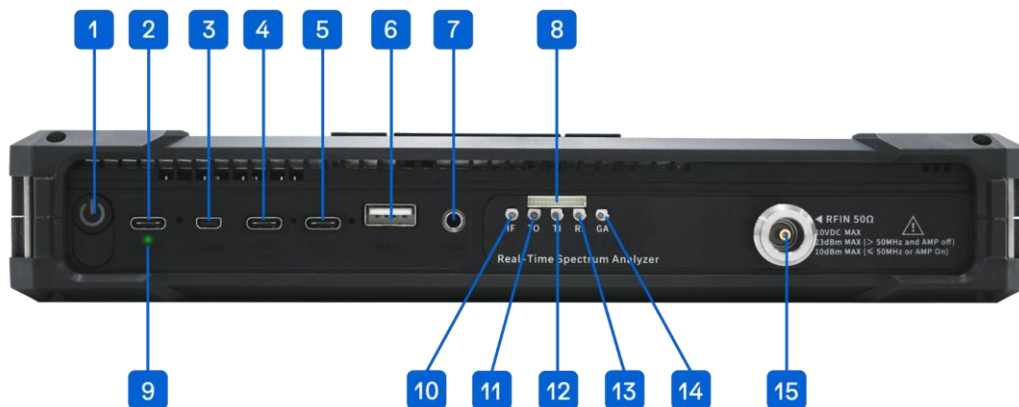

Figure 12 PX series instruments upper board interface description

**Table 10 PX Series Interface Description**

| No | Interface Name | Description   |
|----|----------------|---|
| 1  | Power Button   | On/Off instrument   |
| 2  | Charging port  | Instrument charging port, USB PD3.0 20 V 3.25 A, please connect the power supply according to the instrument's required operating voltage   |
| 3  | Micro HDMI     | For extended display  |
| 4  | USB3           | USB interface: USB3 is USB 3.0 interface, USB1 and USB2 are USB 2.0 interface. This interface connects to external storage devices, USB keyboards, or mice. It can also be used to connect a driver-free Hub with an Ethernet port, allowing the instrument to be remotely controlled by a PC via network cable |
| 5  | USB2           |   |
| 6  | USB1           |   |

|    |                       |  |
|----|-----------------------|--|
| 7  | Audio Output          | 3.5mm headphone jack. Volume can be adjusted via the menu: "System" -> "Device" -> "Volume."                 |
| 8  | Multifunctional AUXIO | For a detailed description, please refer to Table 11.  |
| 9  | Charging Indicator    | Green flashing means charging, green always on means full.   |
| 10 | Analogue IF output    | MMCX (F), max. output power -25 dBm, output impedance 50 $\Omega$  |
| 11 | Trigger Output        | 3.3V CMOS  |
| 12 | Trigger Input         | MMCX (F), 3.3V CMOS, high-impedance input, max trigger rate 500 times/s                                      |
| 13 | Reference Clock Input | MMCX (F), Amplitude $\geq 1.5$ Vpp, Input Impedance 330 $\Omega$ . Supports Sine, Square, Peak Clipping Sine |
| 14 | GNSS Antenna          | MMCX (F), amplitude 1.5Vpp, input impedance 330 $\Omega$   |
| 15 | RF Signal Input       | PXE-200: N (F), input impedance 50 $\Omega$<br>PXN-400: 2.4mm (M), input impedance 50 $\Omega$               |

**Table 11 Pin description for AUXIO interface 8 (from left to right)**

| Pin | Name          | Direction | Level Standard | Meaning  |
|-----|---------------|-----------|----------------|--|
| 1   | GPIO0         | /         | /              | Reserved   |
| 2   | TRG IO2       | /         | /              | Reserved   |
| 3   | GPIO1         | /         | /              | Reserved   |
| 4   | GND           | /         | /              | Ground   |
| 5   | GPIO2         | /         | /              | Reserved   |
| 6   | 3V3/5VIN      | O         | /              | Power Output, PXN-400 and PXE Series 5 V Outputs         |
| 7   | GPIO3         | /         | /              | Reserved   |
| 8   | GND           | /         | /              | Ground   |
| 9   | USART_TX_FP   | /         | /              | Reserved   |
| 10  | SYNC_RXRFLO   | I         | 3.3V           | RF LO synchronization                                    |
| 11  | SYNC_ADCCLK   | I         | 3.3V           | ADC clock synchronization                                |
| 12  | SYNC_RXIFLO   | I         | 3.3V           | IF LO synchronization                                    |
| 13  | GND           | /         | /              | Ground   |
| 14  | REFCLK_OUT_FP | O         | /              | Reference clock output for 10 MHz standard clock signals |

### 5.3.2 PXZ Series

Please refer to the following table for detailed information on each interface<sup>12</sup>.

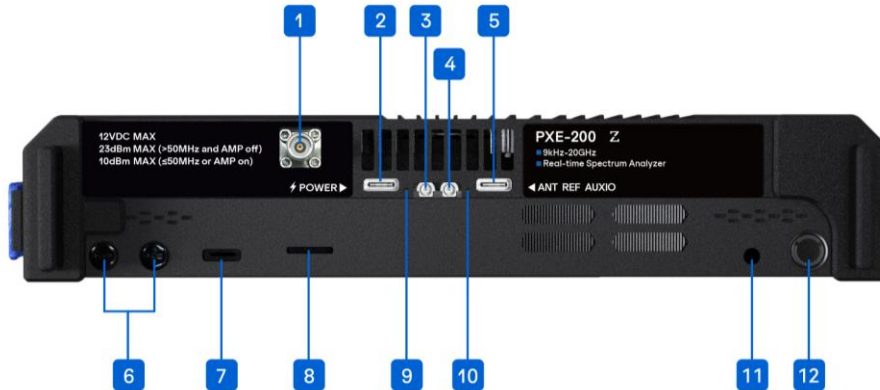

Figure 13 PXZ series instruments upper board interface description

**Table 12 PXZ Series Interface Description**

| No | Interface Name         | Description  |
|----|------------------------|--|
| 1  | RF Signal Input        | PXE-200 Z: 2.92mm (M), input impedance 50 Ω<br>PXN-400 Z: 2.4mm (M), input impedance 50 Ω  |
| 2  | Charging port          | Instrument charging port, USB PD (100W)  |
| 3  | External Antenna Input | MMCX (F), amplitude ≥ 1.5 Vpp, input impedance 330 Ω   |
| 4  | Reference Clock Input  | MMCX (F), Amplitude ≥ 1.5 Vpp, Input Impedance 330 Ω. Supports Sine, Square, Peak Clipping Sine  |
| 5  | Multifunctional AUXIO  | For a detailed description, please refer to Table 13.  |
| 6  | loudness               | Increase/decrease instrument volume  |
| 7  | USB                    | USB3.0 interface. Through this interface to connect the external expansion memory and USB keyboard, mouse; or connect the driver-free Hub with network port, through the network cable to connect to the PC, the PC to the instrument for remote control |
| 8  | SD Card Slot           | Supports microSD, microSDHC or microSDXC memory cards for transferring data between the card and the instrument  |
| 9  | Charging Indicator     | Green flashing means charging, green always on means full.   |
| 10 | GNSS Indicator         | Blue indicates GNSS locked   |
| 11 | Audio Output           | 3.5mm headphone jack. Volume can be adjusted via the menu: "System" -> "Device" -> "Volume."   |
| 12 | Power Button           | Switching the instrument on/off  |

**Table 13 Port 5 Multi-function AUXIO PIN Connector Description (A1-A12 shown from left to right B1-B12 shown from right to left)**

| Pin                                | Name       | Direction | Level Standard | Meaning   |
|------------------------------------|------------|-----------|----------------|---|
| A1/A12                             | GND        | /         | /              | Ground  |
| A2 to A3<br>A5 to A8<br>A10 to A11 | /          | /         | /              | Reserved  |
| A4/A9                              | VBUS OUT   | ○         | /              | Power supply 5 V output   |
| B1/B12                             | GND        | /         | /              | Ground  |
| B2                                 | REFCLK_OUT | ○         | /              | Reference clock output for 10 MHz standard clock signals  |
| B3                                 | TRG_IO2    | ○         | /              | Trigger output, 3.3V CMOS   |
| B4/B9                              | VBUS OUT   | ○         | /              | Power supply 5 V output   |
| B10<br>B5-B8                       | /          | /         | /              | Reserved  |
| B11                                | EXT_TRGIN  |           | /              | External trigger input, 3.3V CMOS input impedance is high resistance, maximum frequency response 500 times/s. |

## 6. GNSS Application Instructions

This chapter explains how to identify the version of the accompanying GNSS module and how to obtain real-time positioning data using either the internal or external GNSS module. The internal module is provided with the instrument, while the external module is selected by the user.

### 6.1 Version Information

The instrument is currently provided with two versions of GNSS modules: Version A is the old version, and Version B is the new version. Both versions are functionally identical, with the only difference being the power supply method. Please refer to the following appearance diagrams to identify the module version in use, and strictly follow the instructions in the corresponding version's chapter for connection to ensure the stable operation of the GNSS module.

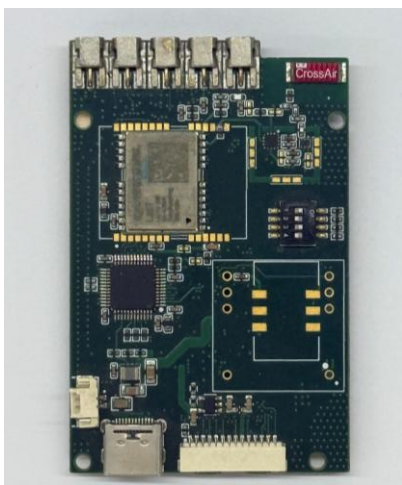

Figure 14 GNSS module version A appearance

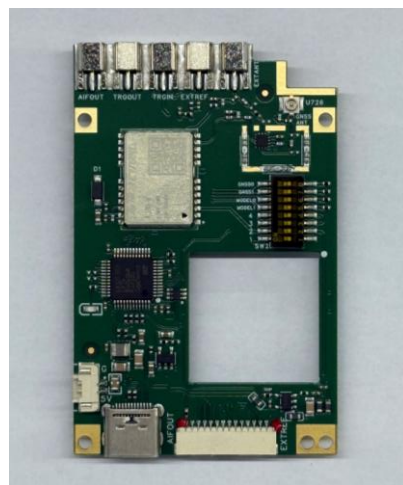

Figure 15 GNSS module version B appearance

### 6.2 GNSS Options

#### 6.2.1 Options Overview

The following accessories are for SA series instruments. NX/PX series instruments have built-in GNSS modules, so to use the GNSS function, you only need to connect the antenna, and do not need to connect the accessories listed below.

Note: 1PPS and 10MHz clock signal outputs from GNSS are not recommended when the GNSS module is unlocked.

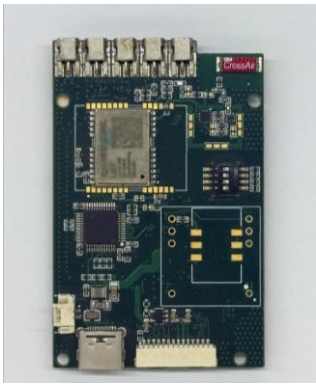

Version A standard GNSS module



Version A high-precision GNSS module



Version A high-quality GNSS module

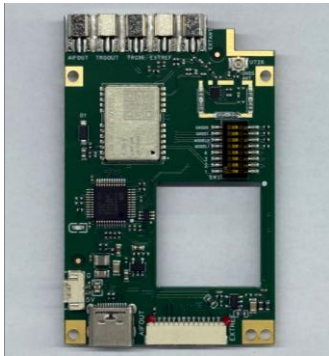

Version B standard GNSS module

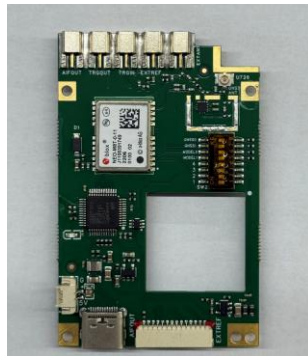

Version B high-precision GNSS module



Version B high-quality GNSS module



Ribbon Cable  
(Connection of external GNSS modules and SA series instruments)



MMCX-to-SMA Cable  
(Connection of antenna and GNSS module)



AUXIO Multi-Function to Type-C Adapter  
(Connection of SAM/SAN series and rows of wires)



MCX-to-MMCX Cable  
(Connection of the reference input of the SAM/SAN instrument and the reference output of the GNSS module)



MMCX Cable  
(Connection of the reference input of the SAE/SAN-400 instrument and the reference output of the GNSS module)

### 6.2.2 Interface Description

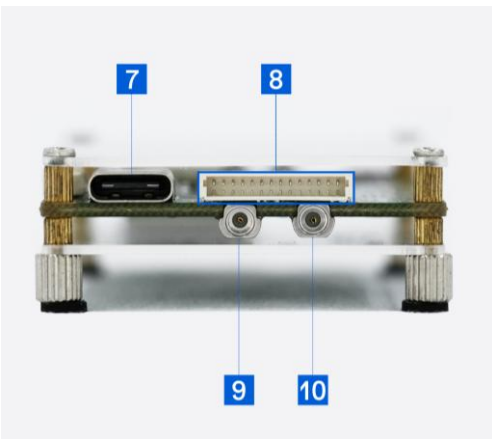
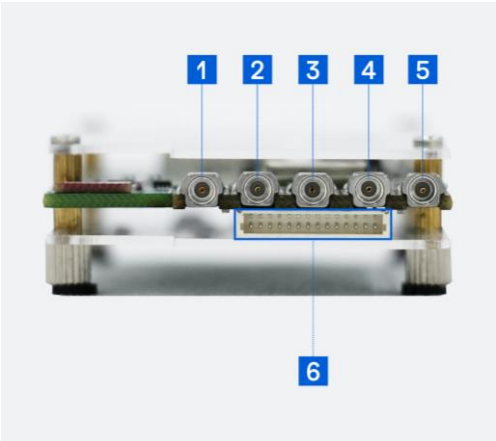

- |  |  |
|--|--|
| <p><b>1</b> External GNSS Antenna Interface</p> <p><b>2</b> External Reference Input Interface</p> <p><b>3</b> External Trigger Input Interface</p> <p><b>4</b> Trigger Output Interface</p> <p><b>5</b> Analog Intermediate Frequency (IF) Output Interface (for SAE/SAN-400 devices)</p> | <p><b>6</b> Reserved Interface</p> <p><b>7</b> Auxiliary Power Supply Type-C Interface (only applicable to high-quality GNSS modules)</p> <p><b>8</b> AUXIO Multi-Function Interface (Trigger Input/Output)</p> <p><b>9</b> Analog Intermediate Frequency (IF) Input Interface (for SAE/SAN-400 devices)</p> <p><b>10</b> 10MHz Reference Clock Output for High-Quality GNSS Modules</p> |
|--|--|

## 6.3 Connection of Internal GNSS Module (Version A)

### 6.3.1 SAE/SAN-400 Series

The operating steps for connecting Version A GNSS option to the SAE/SAN-400 series instrument are as follows:

1. Instrument connection: Instrument [No. 5 AUXIO interface](#) -> GNSS module [No. 8 AUXIO interface](#) (with [the ribbon cable](#)), GNSS module indicator light blinking that is connected successfully.
2. External GNSS antenna connection: antenna -> GNSS module [No. 1 interface](#) (with [MMCX to SMA cable](#)), antenna receiving surface towards the unobstructed sky.
3. GNSS external power supply (high-quality modules only): use a Type-C cable to connect the GNSS module's [No. 7 interface](#) to the power adapter and plug it into an outlet.
4. Reference clock connection (high-quality module only): [MMCX connector No. 4](#) of the instrument -> [MMCX connector No. 10](#) of the GNSS module (with [double-ended MMCX cable](#)).



Figure 16 SAE/SAN-400 module connection with version A GNSS module diagram

### 6.3.2 SAM/SAN Series

The operating steps for connecting Version A GNSS option to the SAM/SAN series instrument are as follows:

1. Instrument Connection: Instrument [No.6 AUXIO interface](#) -> GNSS module [No.8 AUXIO interface](#) (with [AUXIO to Type-C](#) and [Ribbon Cable](#)), GNSS module indicator light blinks that the connection is successful.
2. External GNSS antenna connection: antenna -> GNSS [module 1 interface](#) (with [MMCX to SMA cable](#)), antenna receiving surface towards the unobstructed sky.
3. GNSS external power supply (high-quality module only): Use a Type-C cable to connect the GNSS module's [No. 7 connector](#) to the power adapter and plug it into an outlet.
4. Reference clock connection (high quality module only): [MCX connector No. 4](#) of the instrument -> [MMCX connector No. 10](#) of the GNSS module (with [MCX to MMCX cable](#)).



Figure 17 SAN/SAM module connection with version A GNSS module diagram

### 6.3.3 NX Series

The NX series instruments have built-in GNSS modules. To use them, you only need to connect the antenna, and the receiving side of the antenna is facing to the unobstructed sky. The procedure is as follows:

1. NXE/NXN-400 series: Antenna -> Instrument [4 GA interface](#) (with [MMCX to SMA cable](#)).
2. NXM/NXN series: Antenna -> Instrument [5 GA interface](#) (with [MMCX to SMA cable](#)).

### 6.3.4 PX Series

The PX series instruments have built-in GNSS modules. To use them, you need to connect an external GNSS antenna (with the receiving side facing the unobstructed sky) to the instrument's [No. 14 GA interface](#) via the [MMCX to SMA cable](#).

### 6.3.5 PXZ Series

PXZ series instruments have built-in GNSS module, when using the external GNSS antenna (receiving side towards the unobstructed sky) through the [MMCX to SMA cable](#) connected to the instrument's [No. 3 ANT port](#).

## 6.4 Connection of Internal GNSS Module (Version B)

### 6.4.1 SAE/SAN-400 Series

The operating steps for connecting Version B GNSS option to the SAE/SAN-400 series instrument are as follows:

1. Instrument connection: Instrument [No. 6 AUXIO interface](#) -> GNSS module [No. 8 AUXIO interface](#) (with [the ribbon cable](#)), GNSS module indicator light blinking that is connected successfully.
2. External GNSS antenna connection: antenna -> GNSS module [No. 1 interface](#) (with [MMCX to SMA cable](#)), antenna receiving surface towards the unobstructed sky.
3. GNSS external power supply (high-quality modules only): use a Type-C cable to connect the GNSS module's [No. 7 interface](#) to the power adapter and plug it into an outlet.
4. Reference clock connection (high-quality module only): [MMCX connector No. 4](#) of the instrument -> [MMCX connector No. 10](#) of the GNSS module (with [double-ended MMCX cable](#)).

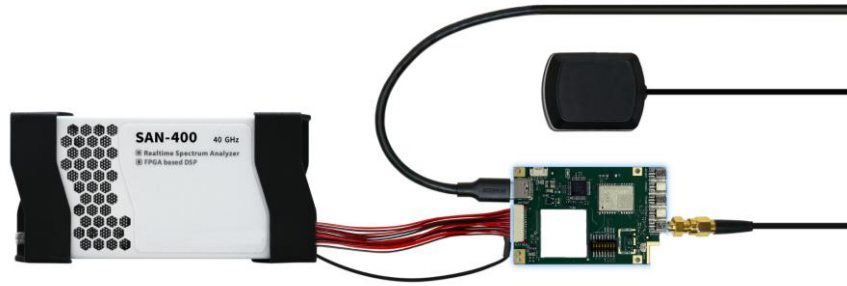

Figure 18 SAE/SAN-400 module connection with version B GNSS module diagram

#### 6.4.2 SAM/SAN Series

The operating steps for connecting Version B GNSS option to the SAM/SAN series instrument are as follows:

1. Instrument Connection: Instrument [No.6 AUXIO interface](#) -> GNSS module [No.8 AUXIO interface](#) (with [AUXIO to Type-C](#) and [Ribbon Cable](#)), GNSS module indicator light blinks that the connection is successful.
2. External GNSS antenna connection: antenna -> GNSS [module 1 interface](#) (with [MMCX to SMA cable](#)), antenna receiving surface towards the unobstructed sky.
3. GNSS external power supply (high-quality module only): Use a Type-C cable to connect the GNSS module's [No. 7 connector](#) to the power adapter and plug it into an outlet.
4. Reference clock connection (high quality module only): [MCX connector No. 4](#) of the instrument -> [MMCX connector No. 10](#) of the GNSS module (with [MCX to MMCX cable](#)).



Figure 19 SAN/SAM module connection with version B GNSS module diagram

#### 6.4.3 NX Series

The NX series instruments have built-in GNSS modules. To use them, you only need to connect the antenna, and the receiving side of the antenna is facing to the unobstructed sky. The procedure is as follows:

1. NXE/NXN-400 series: Antenna -> Instrument [4 GA interface](#) (with [MMCX to SMA cable](#)).
2. NXM/NXN series: Antenna -> Instrument [5 GA interface](#) (with [MMCX to SMA cable](#)).

#### 6.4.4 PX Series

The PX series instruments have built-in GNSS modules. To use them, you need to connect an external GNSS antenna (with the receiving side facing the unobstructed sky) to the instrument's [No. 14 GA interface](#) via the [MMCX to SMA cable](#).

#### 6.4.5 PXZ Series

PXZ series instruments have built-in GNSS module, when using the external GNSS antenna (receiving side towards the unobstructed sky) through the [MMCX to SMA cable](#) connected to the instrument's [No. 3 ANT port](#).

#### 6.5 Connection of External GNSS Module

The instrument supports access to an external GNSS module of the user's choice via USB to serial port. Users can connect the serial output of the module to the following interfaces via USB to serial cable:

- PX-series flatbed instruments: PX: [interface 4](#), PXZ: [interface 7](#)
- SA/NX series kernel type instruments: the instrument corresponds to the USB port of the host computer

The system will recognize it as a virtual serial port and parse the received GNSS data. After successful locking, the GNSS information can be viewed on the software.

# 7. Analogue IF output

## 7.1 Output Intermediate Frequency Signal

1. Connect the signal generator to the instrument's RF input interface, with the signal generator outputting a 1 GHz, 0 dBm signal;
2. Switch the software to Receiver/IQ Stream mode, ensuring that the instrument outputs a stable intermediate frequency (IF) signal;
3. Output the IF signal generated by the instrument to other measuring instruments for viewing through the following interface.
  - SAE/SAN-400 Series: [Interface 2](#)
  - NXE/NXN-400 Series: [Interface 9](#)
  - PX Series: [Interface 10](#)

## 7.2 Viewing the Intermediate Frequency Signal

1. The frequency of the simulated intermediate frequency output signal is between 307.2 MHz  $\pm$  50 MHz, with a maximum output power of -25 dBm and an output impedance of 50  $\Omega$ . The center frequency of the simulated IF output for each instrument can be found in the IF calibration file within the "/bin/CalFile" folder of the instrument's software directory;

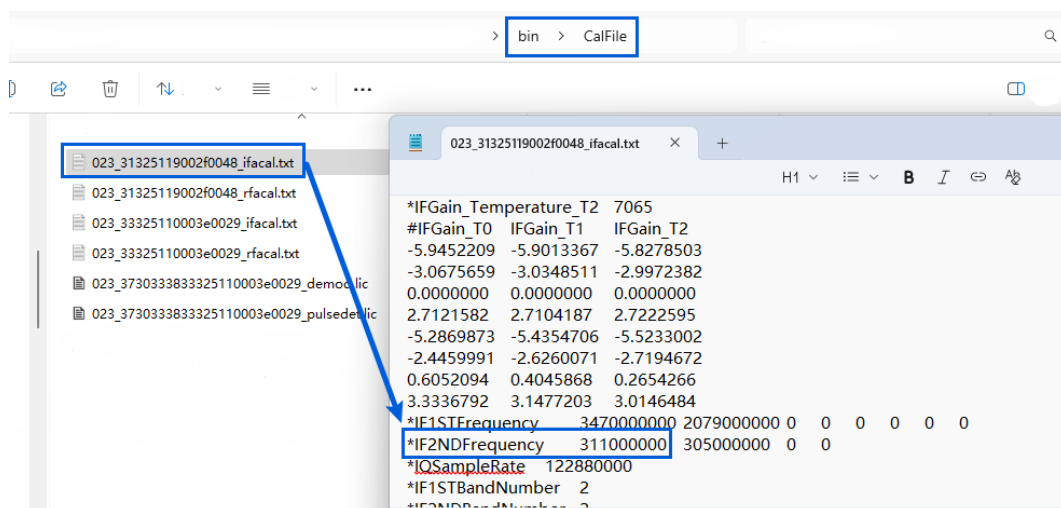

- Figure 20 View the simulated intermediate frequency output frequency points
2. Set the "Center Frequency" of the measuring instrument to 311 MHz (refer to the corresponding calibration file for the specific value), and keep the other parameters at their default settings. Then, view the intermediate frequency output.



Figure 21 View the intermediate frequency output signal.

## 8. Modify the IP address of the NX-Series instrument

Go to the official website of HAROGIC (<https://www.harogic.com/setdeviceipaddr-2/>) to download and extract the "SetDeviceIPAddr.zip" folder to your desktop or other directory.

### 8.1 Obtaining NX-Series Instrument IP Addresses

1. Default IP address: "192.168.1.100" (not modifiable), "192.168.3.100" (modifiable).
2. Instruments through the direct connection or access to the router, to ensure that and the host computer in the same network segment.
3. Run "SetDeviceIPAddr\SetDeviceIPAddr.exe" to check the IP address of the instrument.

### 8.2 Modifying NX-Series Instrument IP Addresses

#### 8.2.1 Notes on IP modification

1. To ensure that the IP of the receiver network card and the host computer other non-physical connection of the network card's IP address is in a different network segment, in order to avoid network conflicts.
2. IP address cannot end with ".0", ".1" or ".255", these addresses have a special purpose in the network (such as network address, broadcast address or gateway address), the use of them may lead to communication anomaly ), and their use may lead to communication anomalies.

#### 8.2.2 IP Modification Procedure

Run "SetDeviceIPAddr\SetDeviceIPAddr.exe".

1. Single instrument
  - Enter the IP address (in standard format, e.g., 192.168.3.101)
  - Enter the subnet mask (CIDR format, e.g. 255.255.255.0)
  - Press the Enter key to execute the modification, and the prompt "Change ip address successfully" indicates success

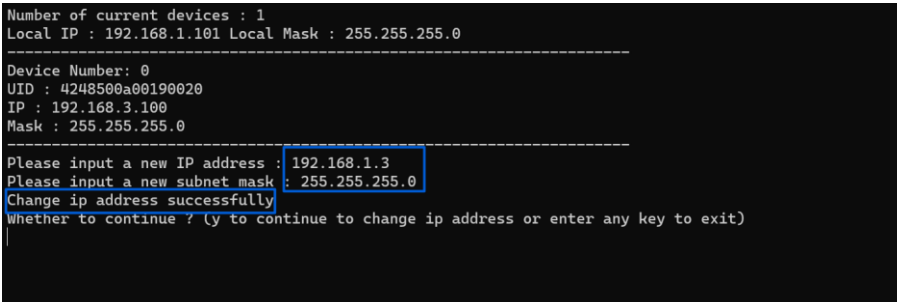

```
Number of current devices : 1
Local IP : 192.168.1.101 Local Mask : 255.255.255.0
-----
Device Number: 0
UID : 4248500a00190020
IP : 192.168.3.100
Mask : 255.255.255.0
-----
Please input a new IP address : 192.168.1.3
Please input a new subnet mask : 255.255.255.0
Change ip address successfully
Whether to continue ? (y to continue to change ip address or enter any key to exit)
```

Figure 22 Single NX Instrument Modification IP

2. Multiple instruments
  - Enter the instrument numbers in sequence (each instrument corresponds to a unique Device Number, take the instrument with UID 33325110003e0029 as an example)
  - Enter the IP address and subnet mask (in the same format as above)
  - Press the Enter key to execute the modification, and the prompt "Change ip address successfully" indicates success

```
Number of current devices : 2
Local IP : 192.168.1.101 Local Mask : 255.255.255.0
-----
Device Number: 0
UID : 33325110004d004e
IP : 192.168.100.66
Mask : 255.255.255.0
-----
Device Number: 1
UID : 4248500a00190020
IP : 192.168.1.3
Mask : 255.255.255.0
-----
Please input "Device Number" that needs to be configured : 0
Please input a new IP address : 192.168.1.4
Please input a new subnet mask : 255.255.255.0
Change ip address successfully
Whether to continue ? (y to continue to change ip address or enter any key to exit)
|
```

Figure 23 IP modification for multiple NX instruments

# 9. PX Remote Control Guide

## 9.1 Network port direct connection

1. Connect the driverless docking station with network port to the USB 3.0 interface (USB3) on the upper panel of the instrument, and connect it to the network port of the computer or embedded instrument via a network cable. Note: USB1 and USB2 are USB 2.0 interfaces, it is recommended to use the USB3 interface in preference for better performance.



Figure 24 External drive-free docking station with network port

2. Exit the current host computer software, enter the PC "Settings -> Network and Internet -> Properties", manually configure the IPv4 address (such as "192.168.1.2") and subnet mask ("255.255.255.0"), ensure that the same network segment as the instrument IP ("192.168.1.100"), and the instrument IP ("192.168.1.100"). "255.255.255.0", make sure that it is in the same network segment as the instrument IP ("192.168.1.100").

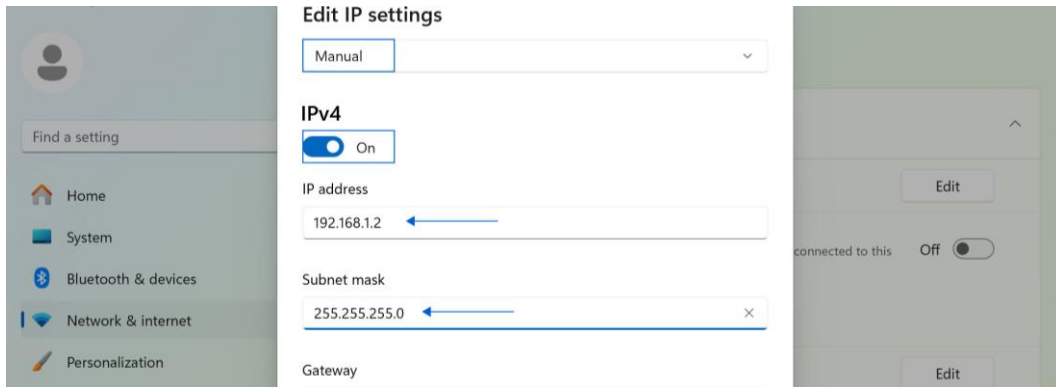

Figure 25 Configuring IP Addresses and Subnet Masks

3. Through the cmd execution "ping 192.168.1.100" to verify network connectivity.

```
C:\WINDOWS\system32\cmd. x + v
Microsoft Windows [Version 10.0.22631.4037]
(c) Microsoft Corporation. All rights reserved.

C:\Users\10418>ping 192.168.1.100

Pinging 192.168.1.100 with 32 bytes of data:
Reply from 192.168.1.100: bytes=32 time<1ms TTL=64
Reply from 192.168.1.100: bytes=32 time<1ms TTL=64
Reply from 192.168.1.100: bytes=32 time<1ms TTL=64
Reply from 192.168.1.100: bytes=32 time<1ms TTL=64

Ping statistics for 192.168.1.100:
    Packets: Sent = 4, Received = 4, Lost = 0 (0% loss),
    Approximate round trip times in milli-seconds:
        Minimum = 0ms, Maximum = 0ms, Average = 0ms
```

Figure 26 Test instrument network connectivity (ping command)

4. Double-click to open the PC host software directory "configuration\Settings.ini" file, set Interface = ETH;
5. From the userdata folder on the desktop of the instrument, enter the "/bin/CalFile" path of the software to get the calibration file and save it to the "\bin/CalFile" directory of the corresponding software on the PC.

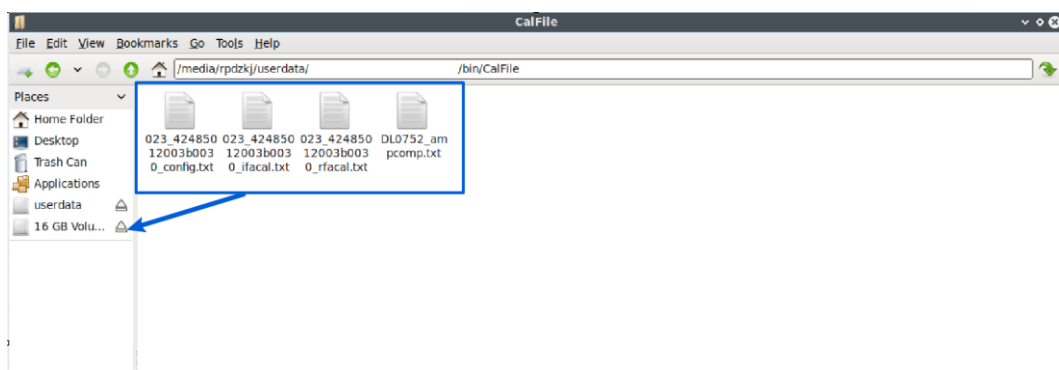

Figure 27 Obtaining Instrument Calibration Documentation

6. Start the executable programme in the "/bin" folder in the software directory of the PC to achieve remote control of the PX series instruments.

⚠ Note: The instrument and the PC software cannot be switched on at the same time.



Figure 28 Remote control of PX instruments by direct connection through the network port

## 9.2 LAN connectivity

1. Connect the driver-free docking station with network port to the USB 3.0 interface (USB3) on the upper panel of the instrument, and connect it to the network port of the router through the network cable. Note: USB1 and USB2 are USB 2.0 ports, it is recommended to use the USB3 port in preference for better performance;



Figure 29 Connecting the Router to the Instrument

2. Click the menu bar "File" -> "Exit", exit the software interface in the instrument;
3. Click "userdata" -> "Tools" -> "Open Current Folder in Terminal";

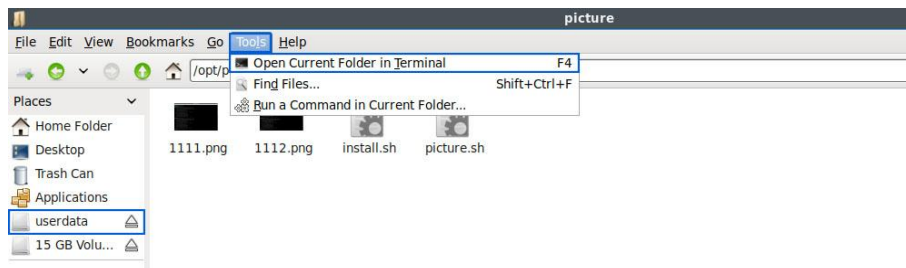

Figure 30 Open terminal

4. In the terminal, type "ifconfig" query the current router to the IP address assigned to the instrument, in this case, the IP address is "192.168.31.55";

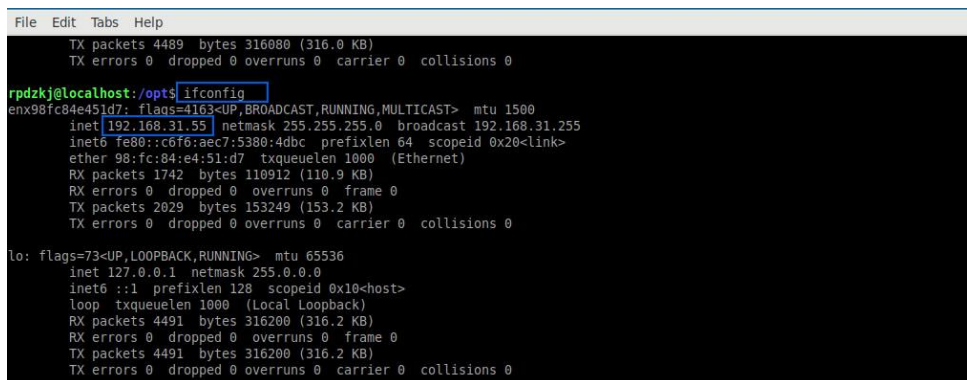

Figure 31 Query the dynamic IP acquired by the instrument

5. Connect the PC to the same router via Wi-Fi to ensure that it is on the same LAN as the instrument. Double-click to open the "configuration\Settings.ini" file in the directory of the PC host software, set Interface = ETH, Address = "192.168.31.55 "
6. For the next steps, please refer to [step 5](#) to [step 6](#) of the chapter on the [Network port direct connection](#).



Figure 32 Remote control of PX instruments by LAN

### 9.3 OTG Connection

1. Connect the instrument's USB 3.0 interface (USB3) to the host computer's USB port using a USB cable;
2. Click "File" -> "Exit" in the menu bar to return to the instrument's desktop. Click the "OTG" icon on the desktop, and after the window pops up, observe the content of the window:
  - If the window displays "OTG is enabled," manually restart the instrument
  - If "OTG is disabled" appears, close the pop-up window, click the "OTG" icon again, and then manually restart the instrument

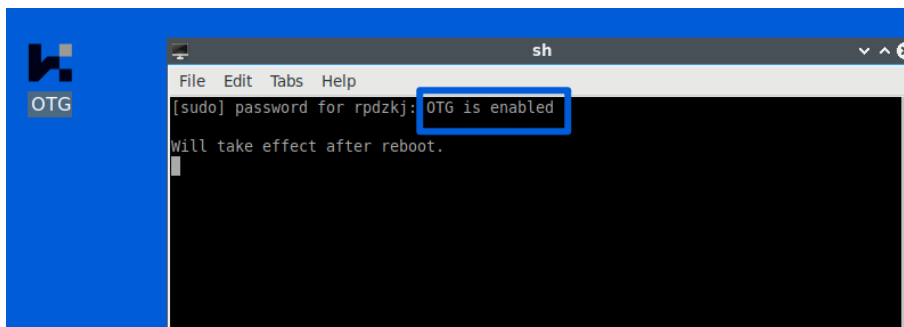

Figure 33 Check the OTG startup status

3. Refer to Steps 2 to 6 in the [Network port direct connection](#) section to configure the network and remotely control the instrument.

Distribution in the UK & Ireland



**Lambda Photometrics Limited**

Lambda House Batford Mill  
Harpenden Herts AL5 5BZ  
United Kingdom

**E:** [info@lambdaphoto.co.uk](mailto:info@lambdaphoto.co.uk)

**W:** [www.lambdaphoto.co.uk](http://www.lambdaphoto.co.uk)

**T:** +44 (0)1582 764334

**F:** +44 (0)1582 712084