



**Probing Solutions.
Made in Germany.**

Distribution in the UK & Ireland



Lambda

www.lambdaphoto.co.uk



HSDP Series

**High-Speed Differential Probes
with Universal BNC Interface**

up to >4GHz, $\pm 42\text{V}$, 7.5m

Preliminary

Instruction Manual



Copyright © 2024 PMK - All rights reserved.

Manufacturer

PMK Mess- und Kommunikationstechnik GmbH
Königsteiner Str. 98
65812 Bad Soden, Germany

Tel: +49 (0) 6196 999 5000

Internet: www.pmk.de
E-Mail: sales@pmk.de

Warranty

PMK warrants this product for normal use and operation within specifications for a period of one year from date of shipment and will repair or replace any defective product which was not damaged by negligence, misuse, improper installation, accident or unauthorized repair or modification by the buyer. This warranty is applicable only to defects due to material or workmanship. PMK disclaim any other implied warranties of merchantability or fitness for a particular purpose. PMK will not be liable for any indirect, special, incidental, or consequential damages (including damages for loss of profits, loss of business, loss of use or data, interruption of business and the like), even if PMK has been advised of the possibility of such damages arising from any defect or error in this manual or product.

Declaration of Conformity



PMK declares the conformity of this product with the actual required safety standards in accordance with the Low Voltage Directive (LVD) 2014/35/EU:

CE/IEC 61010-031:2015

- Safety requirements for electrical equipment for measurement, control and laboratory use
- Part 031:
Safety requirements for hand-held probe assemblies for electrical measurement and test

WEEE/ RoHS Directives



This electronic product is classified within the WEEE/ RoHS category list as monitoring and control equipment (category 9) and is compliant to the following EC Directives.

EC Directives:

WEEE Directive 2012/19/EU

- Waste Electrical and Electronic Equipment

RoHS Directive 2011/65/EU

- Restriction of the use of certain Hazardous Substances in Electrical and Electronic Equipment

Your help and efforts are required to protect and keep clean our environment. Therefore return this electronic product at the end of its life either to our Service Department or take care of separate WEEE collection and professional WEEE treatment yourself. Do not dispose as unsorted municipal waste.

Table of Contents

Manufacturer.....	2
Warranty.....	2
Declaration of Conformity	2
WEEE/ RoHS Directives	2
Safety Information.....	4
About HSDP Series.....	5
Specifications.....	7
Electrical Specifications	7
Electrical Specifications (Continued)	8
Environmental Specifications	9
Probe Dimensions	9
Probe's power supply pin assignment.....	9
Factory Calibration	9
Typical Frequency Response	10
Typical Differential Input Impedance	11
Typical Input Voltages	11
Typical Rise Time	12
Ordering Information.....	13
Step 1: Select Probe	13
Step 2: Select Power Supply	13
Step 3: Accessories (Continued)	15
Step 4: Select 3D Positioning System	15

Safety Information



Prevent personal injury, fire and product damage.

To avoid personal injury and to prevent fire or damage to this product or products connected to it, review and comply with the following safety precautions. Be aware that if you use this probe assembly in a manner not specified the protection this product provides may be impaired. Only qualified personnel should use this probe assembly.



Use only grounded instruments.

Do not connect the differential probe's ground input to a potential other than earth ground. Always make sure the probe and the measurement instrument are grounded properly.

Connect and disconnect properly.

Connect the probe output to the measurement instrument. Optionally connect the differential probe's ground input to earth ground before connecting the probe's differential inputs to the circuit under test. Disconnect the probe inputs and the probe ground connection from the circuit under test before disconnecting the probe from the measurement instrument.



Observe probe and probe accessory ratings.

Do not apply any electrical potential to the probe input which exceeds the maximum ratings of the probe or the accessories connected to it. In a combination always the lower rating / measurement category applies to both probe and accessories connected to it.

Do not operate with suspected failures.

Refer to qualified service personnel.

Indoor use only.

Do not operate in wet or damp environment. Keep the product dry and clean.

Do not operate the product in an explosive atmosphere.

About HSDP Series

The HSDP series offers best-in-class performance with >2GHz models up to $\pm 42V$ differential input range, and $\pm 8V$ up to >4GHz bandwidth. The high input impedance, low noise, and 60V common mode voltage range the different models ideal for various in-circuit measurements for design, validation, debugging of analog signals, such as used in switched mode power supplies.

The HSDP probes series is also ideal for characterizing a wide range of serial bus designs, supporting the most popular serial bus interfaces, such as USB2.0, Ethernet (GbE), CAN/LIN, I2C, SPI, SATA, FireWire (1394b), FlexRay, HDMI etc.

The HSDP series features the industry standard 2.54mm (0.1") socketed inputs that can easily interface to a variety of connectivity options available in the market. The compact probe head design, and its variety of accessories, makes the HSDP series ideal for probing on today's smallest IC devices.

Individual Connectivity Accessories for Highest Signal Fidelity

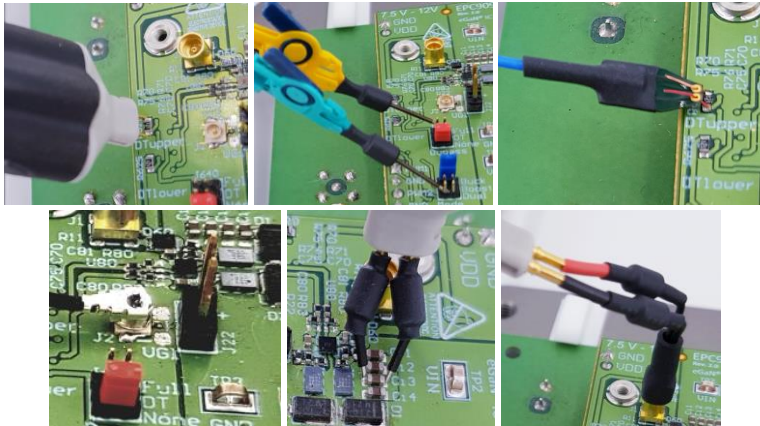

The input offset capability extends the input range of the probe. Having an input capacitance of $<0.6pF \parallel 1M\Omega$ between the probe tips, allows the HSDP Series to be used to probe sensitive circuits without adversely loading the circuit under test.

Differential Input Impedance

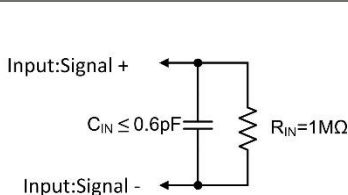

Input Impedance to Earth Ground

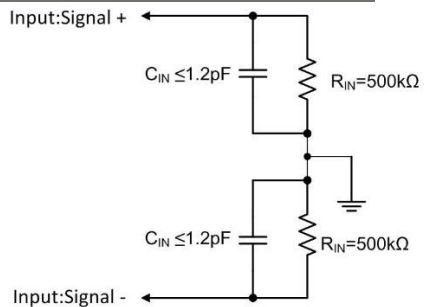

The HSDP-Series uses a PMK custom high speed FET input amplifier that provides a superior high frequency response, as well as low noise and low distortion to accurately capture the signals being measured.

All models are available with either a 7.5m or 1.3m cable length. Other lengths are available on request. The longer cable versions enable the user to probe remote, hard to reach test points that are impossible with the other probing solution in the market today.

The HSDP Series has a universal BNC output connector and is compatible with any oscilloscope with a 50Ω input impedance, or 1MΩ input impedance and a 50Ω feed-through termination, allowing the HSDP Series to be used on any oscilloscope in the lab.

HSDP-Series' DC offset can be controlled via remote control. The "PMK Probe Control" software provides the ability for the user to control the probe remotely via a computer, and provides the user with a graphical user interface. The software is free of charge, and included with PMK's 2ch and 4ch power supplies, PS2 and PS3, which are required to power the probe. The PS2 and PS3 power supplies have a USB interface as well as an optional LAN interface. The new AP-01, 1 channel battery pack power supply, provides >8h of portable and isolated operation, which allows the user the flexibility of where the probe can be used. The AP-01 supplies power only to the probe with no software remote control.

Input Voltage Range Examples

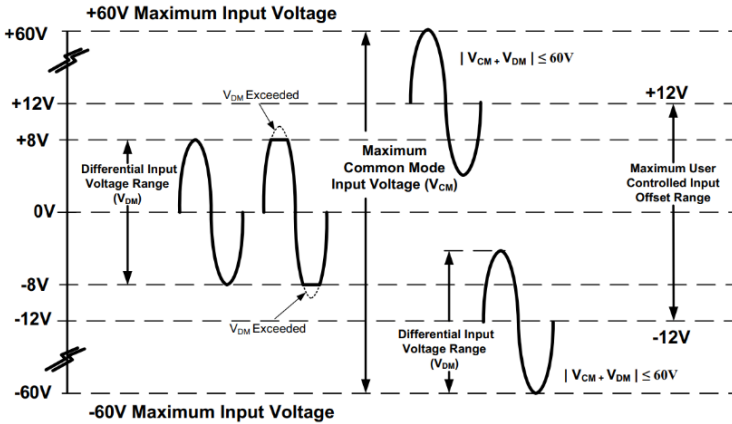

10:1 Models: HSDP4010 / HSDP2010 / HSDP2010L

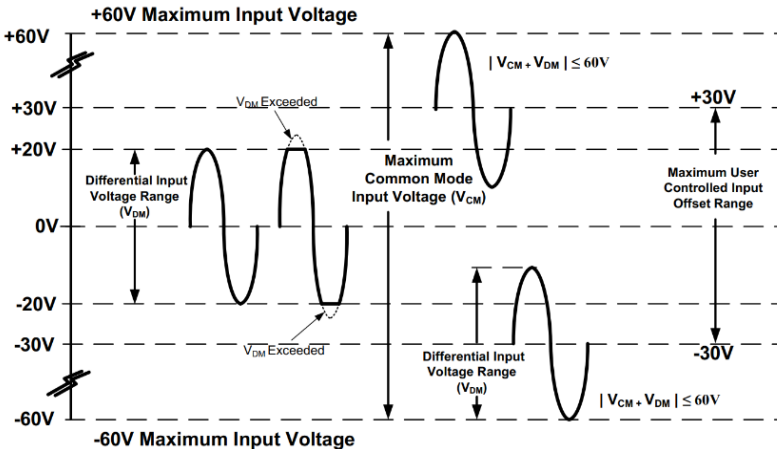

25:1 Models: HSDP2025 / HSDP2025L

Specifications

Read the Instruction Manual before first use, and keep it for future reference. A digital copy of the latest Instruction Manual revision can be downloaded at www.pmk.de

Specifications that are not marked with (*) as guaranteed are typical. Warm-up time is 20 minutes.

The electrical specifications are separated in multiple tables. Each specification is determined when using a PS2 power supply at +23 °C ambient temperature. This probe comes with 1 year warranty.

Electrical Specifications

Model Number	Attenuation Ratio (± 2 % at DC)	Bandwidth (-3dB)	Differential Voltage Range (DC + AC peak) ¹	Differential DC Offset Range
HSDP4010	10:1	> 4 GHz 4.2 GHz (typ.)	± 8 V (16 V _{pp})	± 12 V
HSDP2010	10:1	> 2 GHz 2.3 GHz (typ.)	± 8 V (16 V _{pp})	± 12 V
HSDP2010L	10:1	> 1.8 GHz 2.0 GHz (typ.)	± 8 V (16 V _{pp})	± 12 V
HSDP2025	25:1	> 2 GHz 2.2 GHz (typ.)	± 20 V (40 V _{pp})	± 30 V
HSDP2025L	25:1	> 1.8 GHz 2.0 GHz (typ.)	± 20 V (40 V _{pp})	± 30 V
HSDP2050	50:1	> 2 GHz 2.2 GHz (typ.)	± 42 V (84 V _{pp})	± 60 V
HSDP2050M	50:1	> 1.8 GHz 2.0 GHz (typ.) <i>preliminary</i>	± 42 V (84 V _{pp})	± 60 V
HSDP2050L	50:1	> 1.8 GHz 2.0 GHz (typ.) <i>preliminary</i>	± 42 V (84 V _{pp})	± 60 V

The following specifications table is valid for all models of HSDP series. Observe the Maximum Non-Destructive Voltages between signal and GND.

Common Mode Voltage Range (DC + Peak LF-AC)¹	± 60 V
Maximum Non-Destructive Voltage between signal and GND (DC + Peak LF-AC)¹	± 60 V
Differential Input Impedance	1 MΩ 0.6 pF
Single-ended Input Impedance	500 kΩ 1.2 pF
Input Coupling of the Measuring Instrument	50 Ω

Notes:

¹ LF less than 10Hz

Electrical Specifications (Continued)

Review also the referring derating over frequency graphs later in this document.

Model Number	Noise (Input referred) ²	Rise time (10%-90%)	Propagation Delay	Common Mode Rejection Ratio (CMRR)
HSDP4010	< 2 mV rms 100 nV/sqrt(Hz) <i>preliminary</i>	< 140ps <i>preliminary</i>	6.7 ns	DC: > 70 dB 1 MHz: > 50 dB 10 MHz: > 45 dB 100 MHz: > 35 dB 500 MHz: > 25 dB 1 GHz: > 25 dB
HSDP2010	< 1.5 mV rms 50 nV/sqrt(Hz)	< 200 ps	6.7 ns	DC: > 70 dB 1 MHz: > 50 dB 10 MHz: > 45 dB 100 MHz: > 35 dB 500 MHz: > 25 dB 1 GHz: > 25 dB
HSDP2010L	< 2.5 mV rms 93 nV/sqrt(Hz)	< 200 ps	30.5 ns	DC: > 70 dB 1 MHz: > 50 dB 10 MHz: > 45 dB 100 MHz: > 35 dB 500 MHz: > 25 dB 1 GHz: > 25 dB
HSDP2025	< 3 mV rms 128 nV/sqrt(Hz)	< 200 ps	6.7 ns	DC: > 70 dB 1 MHz: > 50 dB 10 MHz: > 45 dB 100 MHz: > 35 dB 500 MHz: > 25 dB 1 GHz: > 25 dB
HSDP2025L	< 5 mV rms 238 nV/sqrt(Hz)	< 200 ps	30.5 ns	DC: > 70 dB 1 MHz: > 50 dB 10 MHz: > 45 dB 100 MHz: > 35 dB 500 MHz: > 25 dB 1 GHz: > 25 dB
HSDP2050	< 6 mV rms 250 nV/sqrt(Hz) <i>preliminary</i>	< 200 ps	6.7 ns	DC: > 70 dB 1 MHz: > 50 dB 10 MHz: > 45 dB 100 MHz: > 35 dB 500 MHz: > 25 dB 1 GHz: > 25 dB
HSDP2050M	< 6 mV rms 250 nV/sqrt(Hz) <i>preliminary</i>	< 200 ps	14.5 ns	DC: > 70 dB 1 MHz: > 50 dB 10 MHz: > 45 dB 100 MHz: > 35 dB 500 MHz: > 25 dB 1 GHz: > 25 dB
HSDP2050L	< 10 mV rms TBD nV/sqrt(Hz) <i>preliminary</i>	< 200 ps	30.5 ns	DC: > 70 dB 1 MHz: > 50 dB 10 MHz: > 45 dB 100 MHz: > 35 dB 500 MHz: > 25 dB 1 GHz: > 25 dB

Notes:

²RMS noise [mV] at 500MHz bandwidth; noise in [nV/sqrt(Hz)] at 100MHz

Typical Frequency Response

The frequency response plot shown here is for the probe series without any accessories. Frequency responses with specific accessories are available on request.

Frequency Response – HSDP Series: 2 GHz models

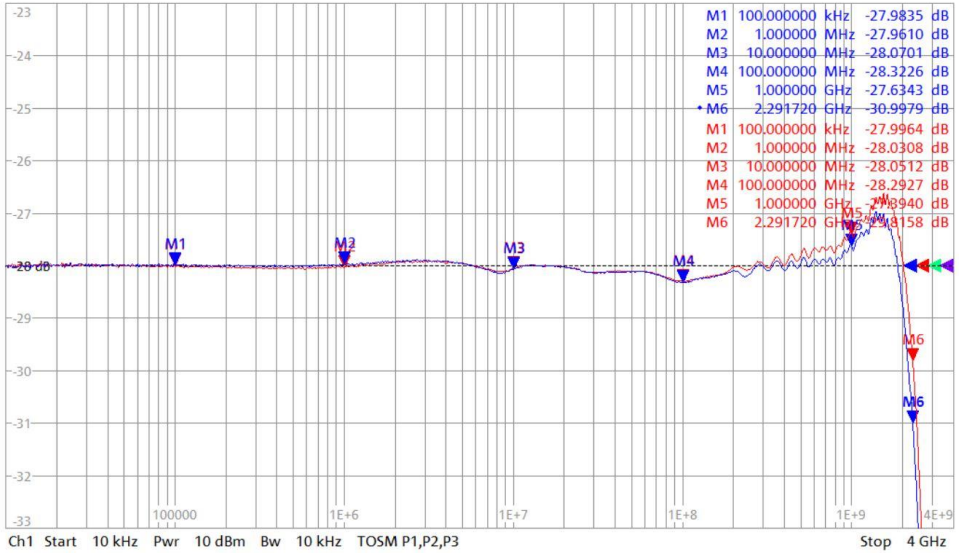

Frequency Response – HSDP Series: 4 GHz models

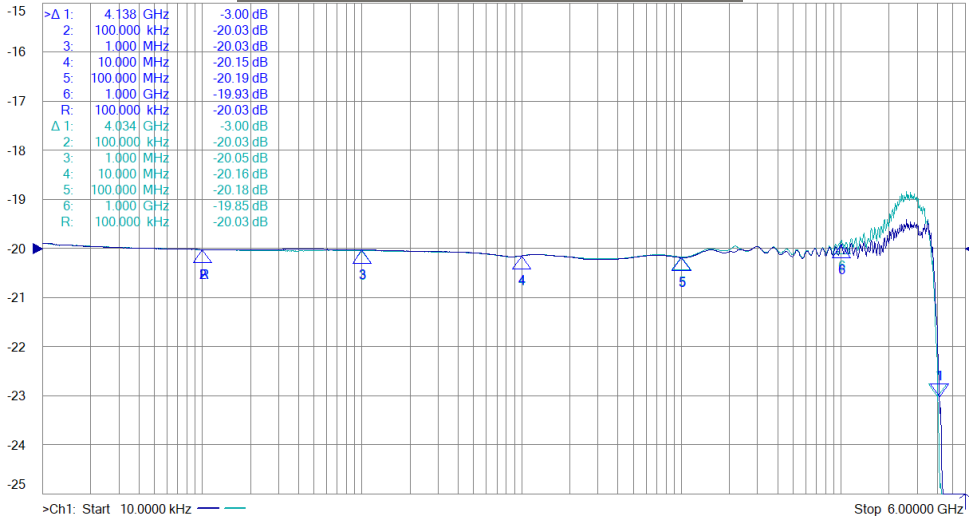

Typical Differential Input Impedance



The input impedance of the probe decreases as the frequency of the applied signal increases.

Typical Differential Input Impedance - HSDP Series

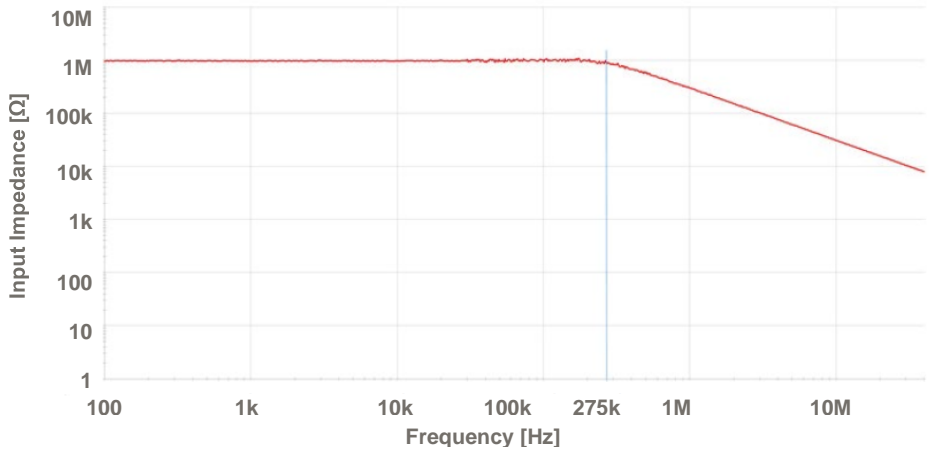

Typical Input Voltages



Note that the maximum input voltage rating of the probe decreases as the frequency of the applied signal increases.

Input Voltage - HSDP2010 / HSDP2010L / HSDP4010

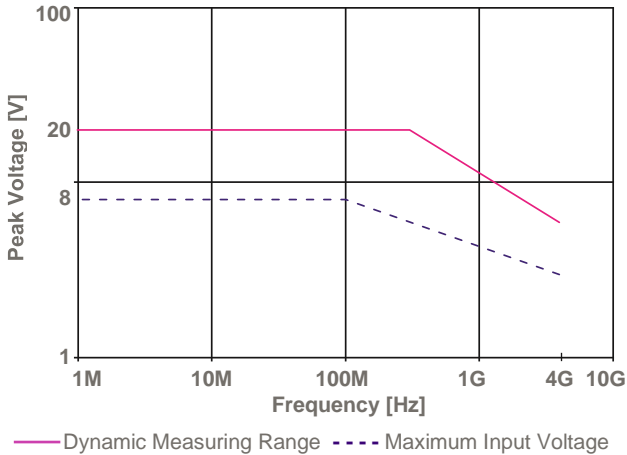

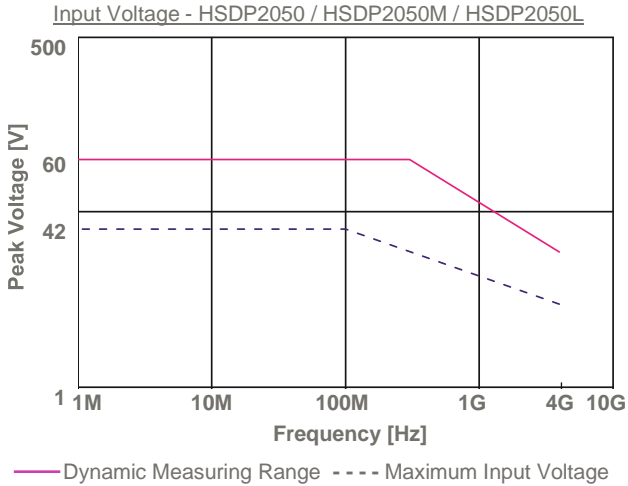
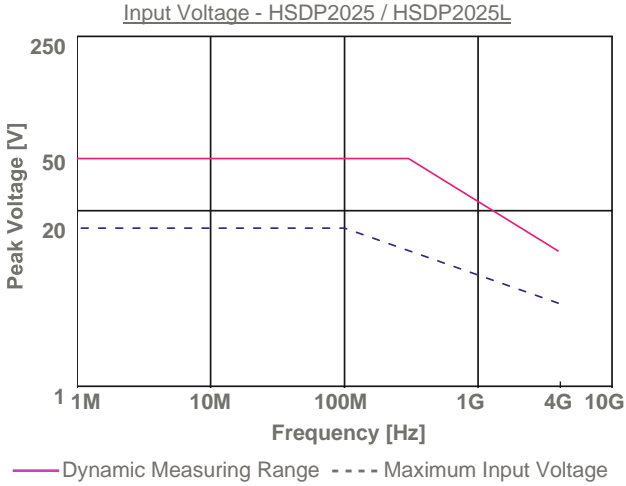

Typical Rise Time

The typical rise time plots are coming soon.

Ordering Information

A power supply with remote control capabilities or a battery pack for portable use are required and optional. The standard accessories are listed in Step 3.

Step 1: Select Probe

Order No.	Item
HSDP4010	Differential probe 4GHz, $\pm 8V$ differential, $\pm 60V$ common mode, 10:1, low noise, 1.3m, including set of standard accessories
HSDP2010	Differential probe 2GHz, $\pm 8V$ differential, $\pm 60V$ common mode, 10:1, low noise, 1.3m, including set of standard accessories
HSDP2010L	Differential probe 1.8GHz, $\pm 8V$ differential, $\pm 60V$ common mode, 10:1, low noise, 7.5m, including set of standard accessories
HSDP2025	Differential probe 2GHz, $\pm 20V$ differential, $\pm 60V$ common mode, 25:1, low noise, 1.3m, including set of standard accessories
HSDP2025L	Differential probe 1.8GHz, $\pm 20V$ differential, $\pm 60V$ common mode, 25:1, low noise, 7.5m, including set of standard accessories
HSDP2050	Differential probe 2GHz, $\pm 42V$ differential, $\pm 60V$ common mode, 50:1, low noise, 1.3m, including set of standard accessories
HSDP2050M	Differential probe 1.8GHz, $\pm 42V$ differential, $\pm 60V$ common mode, 50:1, low noise, 3.5m, including set of standard accessories
HSDP2050L	Differential probe 1.8GHz, $\pm 42V$ differential, $\pm 60V$ common mode, 50:1, low noise, 7.5m, including set of standard accessories

Step 2: Select Power Supply



The power supply pin assignment is different from other power supplies. Use only original PMK power supplies with PMK probes.

Order No.	Item
889-09V-PS2	PS-02 (2 channels, with USB interface for remote control)
889-09V-PS2-L	PS-02-L (2 channels, with LAN and USB interface for remote control)
889-09V-PS3	PS-03 (4 channels, with USB interface for remote control)
889-09V-PS3-L	PS-03-L (4 channels, with LAN and USB interface for remote control)
889-09V-AP01	AP-01 (battery pack, 1 channel, no remote control)
890-520-900	Power supply cable (0.5 m), included in probe's scope of delivery
890-520-915	Power supply cable (1.5 m)

Observe Connector Pin-Out
for PMK power supply cables



Step 3: Accessories







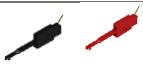

The accessories for this probe series have been safety tested.
Do not use any other accessories or power supplies than what is recommended.

Order No.	Item	Scope of Delivery	Bandwidth (-3dB)	Picture
variable	Differential probe HSDP series model	x	variable	
890-808-105	2-Footer, black	x	n/a	
891-010-814	PCB adaptors, 10x	x	> 2.5 GHz	
890-800-001	Spring tips, gold-plated, 5x	x	> 2.5 GHz	
890-800-000	Solid tips, gold-plated, 5x	x	> 2.5 GHz	
899-000-002	SMD test grabber, 1 Pair, green/yellow	x	> 0.6 GHz	
890-600-214	Solder-In Adapter Flex PCB with Micro coax cable	x	> 1.2 GHz	
890-720-8A6	Y-Lead-Adaptor, 0.8mm Socket to MMCX plug	x	> 1.5 GHz	
018-292-937	Tip Saver	x	> 2.2 GHz	
018-291-913	Z-Ground, 1 pair	x	> 2 GHz	
018-291-914	Active Probe Bent Tip, 1 pair	x	> 1.5 GHz	
890-720-001	Y-Lead to 0.8mm socket for use with 899-000-002 and 890-500-001	x	n/a	
890-600-215	Adapter UF.L with Micro coax cable (optional)		> 1.3 GHz	
890-720-002	Y-Lead-R to 0.8 mm socket, compatible with Micro SMD-Clip 972416100	x	> 1.1 GHz	





Continues on next page.

Step 3: Accessories (Continued)

Order No.	Item	Scope of Delivery	Bandwidth (-3dB)	Picture
890-500-001	QFP IC-Clips long, 1 Pair, black/red	x	> 0.6 GHz	
972416100	Micro SMD clip	x	> 0.5 GHz	
890-010-912	Marker bands 4 x 4 colors	x	n/a	
890-400-808	Ground lead 7cm	x	n/a	
890-400-809	Ground lead 13cm	x	n/a	
890-520-900	Power Supply Cable (0.5 m)	x	n/a	
n/a	Factory Calibration Certificate	x	na	

Step 4: Select 3D Positioning System

Select one of PMK's 3D probe positioning systems with the universal probe holder. The arms and probe holders are also compatible to PMK's SKID positioning systems for probes and PCBs, which are also available for temperature ranges from -55°C to +155°C. To review all 3D positioning solutions, visit us at www.pmk.de

Order No.	Item	Picture
893-350-006	Universal 3D Probe Positioner MSU1500 with steel base (893-100-001), arm with span width 200mm (893-200-200), universal probe holder (893-090-000)	
893-350-011	Universal 3D Probe Positioner with magnet foot (893-100-004), arm with span width 200mm (893-200-200), universal probe holder (893-090-000)	
893-500-START	SKID-S Starter Kit: 3U Board Tester (160 x 160mm) including SKID vertical adapter kit (893-291-501), universal probe holder (893-090-000), PMK probe holder 5-12mm (893-050-000), arm with span width 130 mm (893-200-130) and with 200 mm (893-200-200)	
893-600-START	SKID-M Starter Kit: 6U Board Tester (240 x 160mm) including SKID vertical adapter kit (893-291-501), universal probe holder (893-090-000), PMK probe holder 5-12mm (893-050-000), arm with span width 130 mm (893-200-130) and with 200 mm (893-200-200)	
893-700-START	SKID-M Starter Kit: Board Tester (340 x 300mm) including SKID vertical adapter kit (893-291-501), universal probe holder (893-090-000), PMK probe holder 5-12mm (893-050-000), arm with span width 130 mm (893-200-130) and with 200 mm (893-200-200)	

Distribution in the UK & Ireland



**Characterisation,
Measurement &
Analysis**

Lambda Photometrics Limited
Lambda House Batford Mill
Harpenden Herts AL5 5BZ
United Kingdom

E: info@lambdaphoto.co.uk

W: www.lambdaphoto.co.uk

T: +44 (0)1582 764334

F: +44 (0)1582 712084

Copyright © 2024 PMK - All rights reserved.

Information in this publication supersedes that in all previously published material.
Specifications are subject to change without notice.

Informationen in dieser Anleitung ersetzen die in allen bisher veröffentlichten Dokumenten.
Änderungen der Spezifikationen vorbehalten.