



Probing Solutions.
Made in Germany.

Distribution in the UK & Ireland



Lambda

www.lambdaphoto.co.uk



PHV **X**^{ⓀV} - Series

High Voltage Probes

for Precision Power Electronics Testing

4000 V, >600 MHz, < 3pF

PRELIMINARY

Instruction Manual



Copyright © 2025 PMK - All rights reserved.

Manufacturer

PMK Mess- und Kommunikationstechnik GmbH
Königsteiner Str. 98
65812 Bad Soden, Germany

Tel: +49 (0) 6196 999 5000

Internet: www.pmk.de
E-Mail: sales@pmk.de

Warranty

PMK warrants this product for normal use and operation within specifications for a period of one year from date of shipment and will repair or replace any defective product which was not damaged by negligence, misuse, improper installation, accident or unauthorized repair or modification by the buyer. This warranty covers defects in materials and workmanship only and does not cover wear and tear. PMK disclaims any other implied warranties of merchantability or fitness for a particular purpose. PMK will not be liable for any indirect, special, incidental, or consequential damages (including damages for loss of profits, loss of business, loss of use or data, interruption of business and the like), even if PMK has been advised of the possibility of such damages arising from any defect or error in this manual or product.

Declaration of Conformity



PMK declares the conformity of this product with the actual required safety and environmental standards.

WEEE/ RoHS Directives



This electronic product is classified within the WEEE/ RoHS category list as monitoring and control equipment (category 9) and is compliant to the following EC Directives.

WEEE Directive 2012/19/EU

Waste Electrical and Electronic Equipment

RoHS Directive 2011/65/EU

Restriction of the use of certain Hazardous Substances in Electrical and Electronic Equipment

Your help and efforts are required to protect and keep clean our environment. Therefore, return this electronic product at the end of its life either to our Service Department or take care of separate WEEE collection and professional WEEE treatment yourself. Do not dispose as unsorted municipal waste.

Table of Contents

Manufacturer.....	2
Warranty.....	2
Declaration of Conformity	2
WEEE/ RoHS Directives	2
IEC Safety Information	4
IEC Pollution Degree.....	4
IEC Safety Symbols	4
Safety and Handling Information	5
Safety and Handling Information (continued)	6
About PHVX Series Probes for Precision Power Electronics Testing	7
Factory Calibration	7
Specifications.....	8
Electrical Specifications	8
Mechanical Specifications	8
Environmental Specifications	9
Dimensional Drawing	9
Typical Voltage Derating	9
Typical Input Impedance	10
Probe Accessory Ratings.....	11
PHVX-PCB Adapter 4000V (890-440-001)	11
PHVX-BNC Adapter (890-440-002).....	12
PHVX-Dual adapter to 2mm banana (890-440-003).....	12
PHVX-Sprung Hook red (890-440-004).....	12
PHVX-GND ring "A" for 2500V DC or AC peak (890-440-005)	12
PHVX-GND ring "B" for 4000V DC or AC peak (890-440-015)	13
PHVX-Dual adapter to 2mm banana, with pair of clamps (890-440-009)	13
Set 2 clamps, for use with 2mm banana plugs (890-440-010)	13
Maintenance.....	14
Cleaning.....	14
Changing the Probe Tip	14
Adjustment Procedures	15
Scope of Delivery	16
Ordering Information.....	16

IEC Safety Information

IEC Pollution Degree

According to IEC 61010-1

- | | |
|---------------------------|---|
| Pollution Degree 1 | No POLLUTION or only dry, nonconductive POLLUTION. NOTE: The POLLUTION has no influence. |
| Pollution Degree 2 | Only- nonconductive POLLUTION. Occasionally, however, a temporary conductivity caused by condensation must be accepted. |
| Pollution Degree 3 | Conductive POLLUTION occurs or dry, non-conductive POLLUTION occurs which becomes conductive due to condensation which is to be expected. |

IEC Safety Symbols

The following symbols may appear on the product or in this instruction manual:



Caution, risk of danger. Refer to manual.



Caution, risk of electric shock.



Earth (ground GND) TERMINAL.

Safety and Handling Information

Read the Instruction Manual before first use and keep it for future reference. A digital copy of the latest Instruction Manual revision can be downloaded at www.pmk.de.

For safety reasons, PMK's PHVX probes are not intended for handheld use. They are designed for integration into semi- or fully automated test stations and are considered fixed voltage-measuring components of a test system. This probe series is for use with qualified personnel only. The overall safety of any measurement setup incorporating this probe is the responsibility of the user. To prevent electrical accidents, read the safety instructions carefully. Observe the five safety rules of the German standard series EN 50110-1.



Position and handle the probe only when the circuit under test is de-energized. Use non-handheld and in test setups with safety environment only.

This probe is not for hand-held use. Install the probe in a safety protected test environment and make all required connections and configurations before starting the measurements.



Prevent personal injury, fire and product damage.

To avoid personal injury and to prevent fire or damage to this product or products connected to it, review and comply with the following safety precautions. Be aware that if you use this probe assembly in a manner not specified the protection this product provides may be impaired. Only qualified personnel should use this probe assembly.



Use only grounded instruments.

Do not connect the probe's BNC ground to a potential other than earth ground. Always make sure the probe and the measurement instrument are grounded properly.



Connect and disconnect properly.

Connect the probe output to the measurement instrument and the ground lead to earth ground before connecting the probe to the de-energized circuit under test.

Disconnect the probe input and the probe ground lead from the de-energized circuit under test before disconnecting the probe input from the measurement instrument.



Observe probe and probe accessory ratings.

Do not apply any electrical potential to the probe input which exceeds the maximum ratings of the probe, or the accessories connected to it. In case of a combination, always the lower rating applies to both probe and accessories connected to it.



Keep away from hazardous live circuits.

Avoid open circuitry. Do not touch connections or components when power is present.

Do not operate with suspected failures.

Refer to qualified service personnel.

Indoor use only.

Do not operate in wet or damp environment. Keep the product dry and clean.

Do not operate the product in an explosive atmosphere.



The max. input voltage decreases as the frequency of the applied Sine signal increases (see Voltage Derating curve).

See the relevant section of this manual for further information on maximum input voltage and voltage derating.



The trimmers are sensitive components. Too much mechanical pressure during adjustment might damage the trimmers.

Safety and Handling Information (continued)



Use the ground (GND) accessories only for connections to earth ground.



Handle with care especially when fitted with the extra thin and sharp spring contact tip to avoid any injury. Note that the probe cable is a sensitive part of the probe. Do not damage through excessive bending or pulling. Avoid mechanical shock to this product in general to guarantee accurate performance and protection.



The accessories provided with the probe have been safety tested. Do not use any other accessories than those “originally” provided or recommended.



Before using any input accessory, make sure no tip is interested to the probe input.

Clearance Requirements

Observe all pre-cautions and information from the manual when using this product. See also the specifications and referring derating curves in this manual.



The PHVX series tester probes are for use in a controlled environment, like a semi-conductor tester or test setup with protective cover or interlock only. Maintain a safe clearance of the probe head and accessories in all directions when connected to an energized circuit.

Hazard zone around the probe head and input accessories:

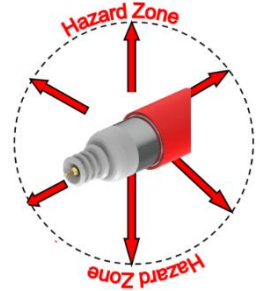

Handling Information

This probe series is NOT FOR HAND-HELD USE.

Adjust the input coupling of the measuring instrument to 1M Ω before connecting the probe to it.

Set the probe's dividing factor in the oscilloscope.

Connect first the BNC output to the oscilloscope, then the ground connection to earth ground- Afterwards connect the probe input to the deenergized circuit under test. When using one of the ground (GND) rings, connect to square pin headers with maximum nominal of 0.64mm.



When using Keysight oscilloscopes, use the special read out for detection of the correct dividing factor, if this option was purchased.



Use ground accessories only for connections to earth ground.



Handle with care especially when fitted with the optional, extra thin and sharp spring contact tip to avoid any injury. Note that the probe cable is a sensitive part of the probe. Do not damage through excessive bending or pulling. Avoid mechanical shock to this product in general to guarantee accurate performance and protection.



Before using any input accessory, make sure no tip is interested in the probe input.

About PHVX Series Probes for Precision Power Electronics Testing

The PHVX high-voltage probe series establishes itself as a best-in-class solution for the evolving demands of modern power electronics design. With the launch of the first 4 kV model, the PHVX4kV, the series is ideal for applications such as low-side V_{DS} measurements during pulse testing of high-speed switching devices like SiC-based components, IGBTs, thyristors, fast-switching HV diodes, and more.

All PHVX models are engineered to deliver precise and consistent results, enabling designers to optimize the performance and efficiency of their power electronic systems with confidence.

- With ultra-low <3 pF input capacitance and a bandwidth exceeding 600 MHz, the PHVX series enables accurate, reliable measurements of fast-switching devices, making it an indispensable tool for engineers developing advanced designs in protected test environments.
- The PHVX series introduces a unique contacting concept that ensures high signal fidelity in high-voltage measurements across various applications. The rotatable 360° ground rings allow flexible, direct connection to 5.08 mm (2.5 kV) or 7.62 mm (4 kV) pitch square pin headers, without adding capacitive loading to the DUT. This enables precise acquisition even at hard-to-reach test points. A wide range of accessories, including soldering adapters, BNC connectors, and additional tools, ensures safe and easy connectivity to the DUT for this non-handheld probe.

All PHVX probes feature a universal BNC output connector and are compatible with any oscilloscope equipped with a 1 M Ω input impedance.

Each voltage model is available in different cable lengths and configurations, optionally with or without intelligent read-out functionality and additional silicone insulation (S) for high-power measurements. The intelligent read-out (RO) enables automatic scaling and identification on the oscilloscope. Fully equipped models including both read-out and silicone insulation are denoted with the suffix –S–RO.

Please refer to the ordering information for a complete list of available models and accessories.

Factory Calibration

All probes are calibrated at end of production. A factory calibration certificate is optional. Annual factory re-calibration is recommended. ISO17025 calibration upon delivery or as re-calibration is possible on request.

Specifications

Read the Instruction Manual before first use and keep it for future reference. A digital copy of the latest Instruction Manual revision can be downloaded at www.pmk.de.

Do not exceed the specifications. Allow the probe to warm up for 20 minutes. This probe comes with 1 year warranty. Each specification is determined at +23 °C ambient temperature. This probe series is not for hand-held use.

Electrical Specifications

Electrical Specifications¹ that are not marked with (*) as guaranteed are typical.

Models ²	All PHVX4kV models
Attenuation* ($\leq \pm 1\%$ guaranteed)	100:1
Maximum Rated Input Voltages¹	
No Measurement Category	4000 V rms / 4000 V pk / 4000 V DC
CAT Rating	not applicable
Pollution Degree	2
DC Gain Accuracy ³	$\pm 0.5\%$ (preliminary)
Input Impedance	50 M Ω < 3 pF
Compensation Range	10 pF – 25 pF
Input Coupling of the Measuring Instrument	1 M Ω



The electrical specifications are valid for use in a controlled environment, like a semi-conductor tester or test setup with protective cover.

Models	PHVX4kV type		
Article numbers ²	PHVX4kV-2-0 PHVX4kV-2-0-RO PHVX4kV-2-S PHVX4kV-2-S-RO	PHVX4kV-3-0 PHVX4kV-3-0-RO PHVX4kV-3-S PHVX4kV-3-S-RO	PHVX4kV-5-0 PHVX4kV-5-0-RO PHVX4kV-5-S PHVX4kV-5-S-RO
Cable Length	2m	3m	5m
Bandwidth* (-3 dB) Small Signal (guaranteed)	> 600 MHz	> 600 MHz	TBD
Rise time (10% - 90%) Large Signal	< 800 ps	< 800 ps	TBD

Mechanical Specifications

Parameter	Specification
Weight (Probe only)	Model dependent
Length ⁴	Model dependent
Probe Input	To position on 0.64mm (0.025") square pin header(s)
Output Connector ⁵	BNC (Male)

Notes:

¹ The rating is based on basic insulation in a controlled environment in accordance with IEC 61010-1.

Also observe further definitions in the probe series' instruction manual, voltage derating graph and probe accessory ratings in the referring manual section.

² Each model is available with different cable lengths, w/o read-out, and w/o extra silicon cable insulation for measurements in high power applications. See "Ordering Information"

³ Input voltage >25%

⁴ Depending on model, available in different lengths

⁵ Depending on model, available with or without read-out

Environmental Specifications

Parameter		Specification
Temperature Range	Operating	0 °C to +50 °C
	Non-Operating	-40 °C to +71 °C
Maximum Relative Humidity	Operating	80 % relative humidity for temperatures up to +31 °C, decreasing linearly to 40 % at +45 °C, non-condensing humidity
	Non-Operating	95 % relative humidity for temperatures up to +40 °C
Altitude	Operating	up to 2000 m
	Non-Operating	up to 15000 m

Dimensional Drawing

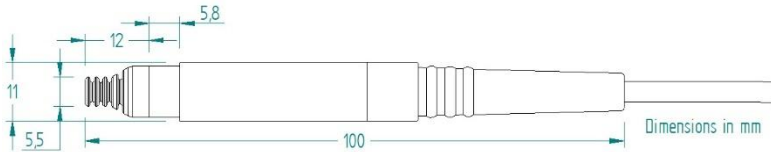

Typical Voltage Derating



Note that the maximum input voltage rating of the probe decreases as the frequency of the applied signal increases.

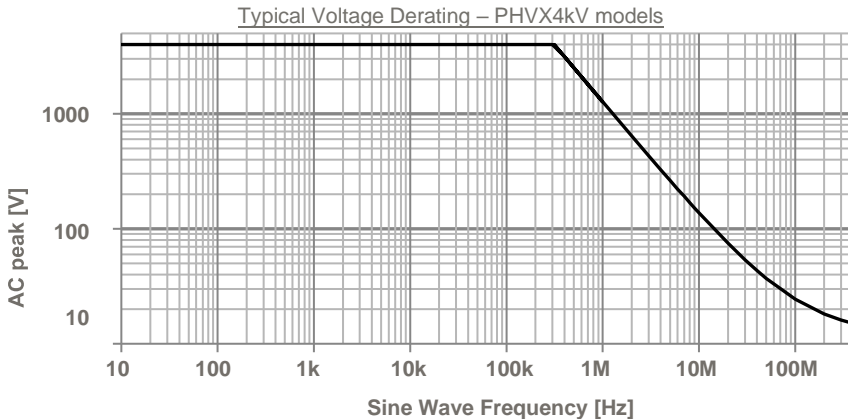

Typical Input Impedance



The input impedance of the probe decreases as the frequency of the applied signal increases.

Typical Input Impedance – PHVX4kV-2 Models (full bandwidth)

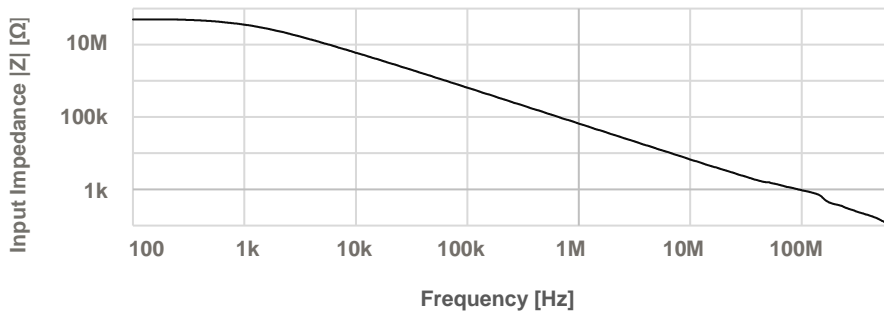

Probe Accessory Ratings



PHVX probes and all accessories are fixed voltage-measuring components of a test system and not intended for handheld use. They are designed for integration into semi- or fully automated test stations only.



Do not exceed the accessory ratings.



Use ground accessories and ground leads only for connections to earth ground.



Make sure no tip is inserted when attaching any other accessory.
Do not use any other accessories than recommended.
The accessories provided with the probe have been safety tested.



Connect and disconnect properly.

Connect the probe output to the measurement instrument and the ground lead to earth ground before connecting the probe to the de-energized circuit under test.

Disconnect the probe input and the probe ground lead from the de-energized circuit under test before disconnecting the probe input from the measurement instrument.

PHVX-PCB Adapter 4000V (890-440-001)

- Pollution Degree: 2
- Maximum Voltage Rating: 4000V DC or AC peak
Tester component, no Measurement Category, not for handheld use



Observe layout requirements.

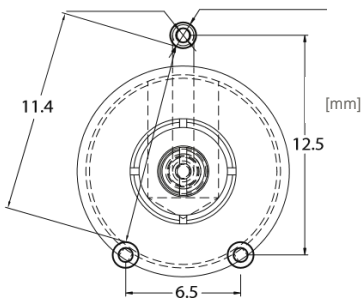

Drilling / Soldering Template

- \varnothing 0.8mm Drilling
- \varnothing 1.4mm Soldering Pads

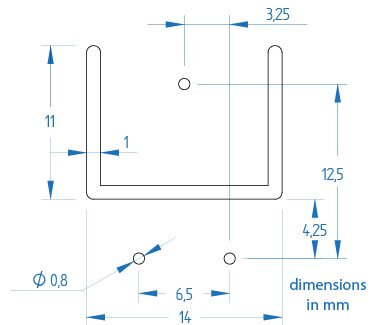

PCB Template

A cut in the PCB beneath the adapter is required to increase the creepage distance between the contacts, otherwise the rating is not valid.



The minimum distance between all solder pads of 11.4mm (see Drilling /Soldering template) must not be undercut under any circumstances.
Undercutting this distance will void the rating.

PHVX-BNC Adapter (890-440-002)

- Pollution Degree: 2
- Maximum Voltage Rating: 750V DC or AC pk
Tester component, no Measurement Category, not for handheld use



PHVX-Dual adapter to 2mm banana (890-440-003)

- Pollution Degree: 2
- Maximum Voltage Rating: 4000V DC or AC peak
Tester component, no Measurement Category, not for handheld use



Observe the minimum required distance between contacts.
See PHVX-PCB Adapter 4kV section for more layout information.



The plastic case of the clamps does not supply adequate isolation.

PHVX-Sprung Hook red (890-440-004)

- Pollution Degree: 2
- Maximum Voltage Rating: 4000V DC or AC peak
Tester component, no Measurement Category, not for handheld use



Observe the minimum required distance between contacts.
See PHVX-PCB Adapter 4kV section for more layout information.

PHVX-GND ring "A" for 2500V DC or AC peak (890-440-005)

- Pollution Degree: 2
- Maximum Voltage Rating: 2500V DC or AC peak
Tester component, no Measurement Category, not for handheld use



Observe the minimum required distance between contacts.



When using pin headers, it is recommended no other connection is in between, otherwise the rating is not valid

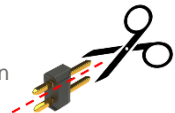

PCB Template:



A cut in the PCB beneath the ground adapter "A" for 5.08mm pitch is required to increase the creepage distance between the contacts, otherwise the rating is not valid

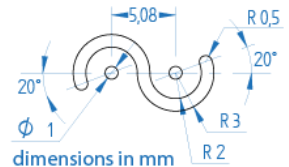

PHVX-GND ring "B" for 4000V DC or AC peak (890-440-015)

- Pollution Degree: 2
- Maximum Voltage Rating: 4000V DC or AC peak
Tester component, no Measurement Category, not for handheld use



Observe the minimum required distance between contacts.

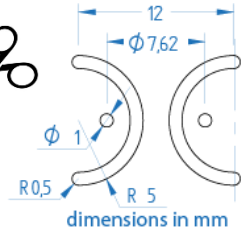
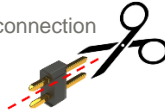

When using pin headers, make sure no other connection is in between, otherwise the rating is not valid

**PCB Template:**

A cut in the PCB beneath the ground adapter "B" for 7.62mm pitch is required to increase the creepage distance between the contacts, otherwise the rating is not valid

PHVX-Dual adapter to 2mm banana, with pair of clamps (890-440-009)

- Pollution Degree: 2
- Maximum Voltage Rating: 4000V DC or AC peak
Tester component, no Measurement Category, not for handheld use



Observe the minimum required distance between contacts. See PHVX-PCB Adapter 4kV section for more layout information.



Pay attention to partial discharge.



The plastic case of the clamps does not supply adequate isolation.

Set 2 clamps, for use with 2mm banana plugs (890-440-010)

- Pollution Degree: 2
- Maximum Voltage Rating: 4000V DC or AC peak
Tester component, no Measurement Category, not for handheld use



Observe the minimum required distance between contacts. See PHVX-PCB Adapter 4kV section for more layout information.



Pay attention to partial discharge.



The plastic case of the clamps does not supply adequate isolation.

Maintenance

Cleaning

To clean the exterior of the probe, use a soft cloth moistened with either distilled water or isopropyl alcohol. Before use allow the probe to dry completely.

Changing the Probe Tip

Different to other PMK probe series, the optional probe tip has to be removed before connecting any PHVX series accessories. To remove or change the probe tip use pliers to grip and pull the golden tip carefully straight out of its contact socket, along the axis of the probe.

(Schematical drawings)

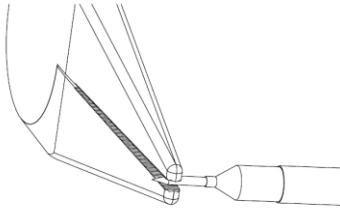

Use pliers to grip and pull the probe tip carefully out of its contact socket.

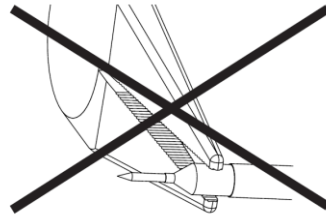

Do not grip the white plastic insulator or the probe housing with pliers.

Do not grip the white plastic insulator or the housing with pliers, because the tip could be squeezed and cannot be removed and respectively the probe could be damaged. If the probe tip is removed, accessories can be added, e.g. the sprung hook, or a new tip can be inserted with pliers into the contact socket, along the axis of the probe. In order to insert the probe tip completely into the housing, press the probe tip against a hard surface carefully.

Verify if the passive probe is compensated correctly.

Adjustment Procedures

All passive probe PHVX models can be adjusted for DC gain, low frequency (LF) compensation and high frequency (HF) compensation. For best results, make sure to have a minimum input voltage of 25% of the specified input voltage range. Users have access to LF compensation only.



The trimmers are sensitive components. Too much mechanical pressure during adjustment might damage the trimmers.

LF Compensation

When the probe is connected to the oscilloscope input the first time, the probe's cable capacitance needs to be matched to the oscilloscope input capacitance. This matching assures good amplitude accuracy from DC to the probe's bandwidth.

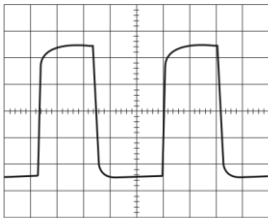

undercompensated

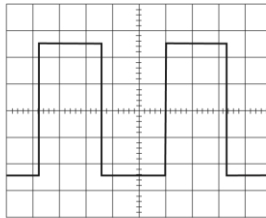

optimum

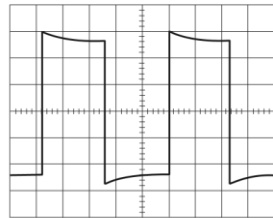

overcompensated

A poorly compensated probe clearly influences the overall system performance (probe + scope) and causes measurement errors resulting in inaccurate readings and distorted waveforms.

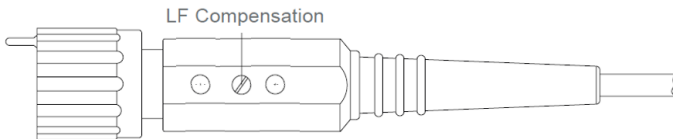

LF compensation is performed by connecting the probe to a voltage calibration generator and adjusting the LF compensation trimmer to optimum square wave response.

For calibration with PMK's 1000V voltage calibration generator KHT1000, the PHVX-BNC adapter can be used.

Scope of Delivery

See chapter “Ordering Information” to review the selection of accessories.

- 1x PHVX series probe
- 1x **890-440-005** PHVX-GND ring “A” for 2500V DC or AC peak,5.08mm pitch
- 2x Spring tip, gold-plated
- 2x Solid tip, gold-plated
- 1 **890-440-008** PHVX-GND ring with 10cm GND lead to 2mm banana, with clamp
- 1x **890-880-101** Set of 10 Contact Pins 0.64mm
- 3x Pin connectors, 7 pin single row, pin width 0.635m (SL 1 053 7 G)
- 1x Set cable coding rings 14mm (3x4 colors)
- 1x **018-292-007** Trimmer tool
- 1x Instruction manual

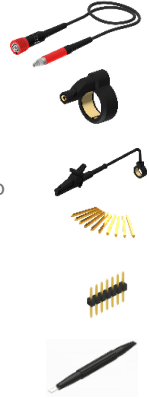

Ordering Information

Step 1: Select Base Probe

Each voltage model is available in different cable lengths and configurations, w/o intelligent read-out function, and w/o additional Silicon insulation (S) for high power measurements. The optional read-out (RO) features intelligent communication with automatic scaling on the oscilloscope display. The fully equipped model with intelligent read-out and extra Silicon insulation end with nomenclature -S-RO.

4000V DC / 4000V pk, **2m cable length**, >600MHz, 100:1 divider models:

PHVX4kV-2-0-RO	with read-out
PHVX4kV-2-S-RO	with readout, with additional Silicon insulation for high current applications
PHVX4kV-2-0	no readout
PHVX4kV-2-S	no readout, with additional Silicon insulation for high current applications

4000V DC / 4000V pk, **3m cable length**, >600MHz, 100:1 divider models:

PHVX4kV-3-0-RO	with read-out
PHVX4kV-3-S-RO	with readout, with additional Silicon insulation for high current applications
PHVX4kV-3-0	no readout
PHVX4kV-3-S	no readout, with additional Silicon insulation for high current applications

4000V DC / 4000V pk, **5m cable length**, bandwidth TBD, 100:1 divider models:

PHVX4kV-5-0-RO	with read-out
PHVX4kV-5-S-RO	with readout, with additional Silicon insulation for high current applications
PHVX4kV-5-0	no readout
PHVX4kV-5-S	no readout, with additional Silicon insulation for high current applications

Step 2: Select Additional Accessories

More PHVX-series connectivity options are in planning. If no fitting solution is shown below, please reach out to sales@pmk.de with your specific need and application information.

890-440-001	PHVX-PCB Adapter 4000V max 4000V DC or AC peak (observe layout requirements) same footprint as PMK's high voltage PCB-Adapter 5.0-L for PMK's PHV1000/2000 series
890-440-002	PHVX-BNC Adapter
890-440-003	PHVX-Dual adapter to 2mm banana
890-440-004	PHVX-Sprung Hook (red)
890-440-005	PHVX-GND ring "A" for 2500V DC or AC peak (observe layout requirements) with 5.08mm pitch, for >360° rotational angle <i>included in scope of delivery</i>
890-440-015	PHVX-GND ring "B" for 4000V DC or AC peak (observe layout requirements) with 7.62mm pitch, for >360° rotational angle
890-440-007	PHVX-GND ring with GND lead to 2mm banana, without clamp
890-440-008	PHVX-GND ring with GND lead to 2mm banana, with clamp <i>included in scope of delivery</i>
890-800-001	Spring tips, gold-plated, 5x
890-800-000	Solid tips, gold-plated, 5x
890-440-009	PHVX-Dual adapter to 2mm banana, with pair of clamps (red/black)
890-440-010	Set 2 clamps (red/black), for use with PHVX-Dual adapter



Step 3: Select optional Calibration Certificate

KAL-PHVX4kV	factory calibration certificate
KAL-DAKKS-PHVX4kV	ISO 17025 (re-)calibration certificate

Distribution in the UK & Ireland



**Characterisation,
Measurement &
Analysis**

Lambda Photometrics Limited

Lambda House Batford Mill

Harpenden Herts AL5 5BZ

United Kingdom

E: info@lambdaphoto.co.uk

W: www.lambdaphoto.co.uk

T: +44 (0)1582 764334

F: +44 (0)1582 712084

Copyright © 2025 PMK - All rights reserved.

Information in this publication supersedes that in all previously published material.
Specifications are subject to change without notice.

Informationen in dieser Anleitung ersetzen die in allen bisher veröffentlichten Dokumenten.
Änderungen der Spezifikationen vorbehalten.