



Distribution in the UK & Ireland



Lambda Photometrics Limited
Lambda House Batford Mill
Harpenden Herts AL5 5BZ
United Kingdom
E: info@lambdaphoto.co.uk
W: www.lambdaphoto.co.uk
T: +44 (0)1582 764334
F: +44 (0)1582 712084

TF-AENET-STP

Automotive Ethernet Compliance Test Solution



User Guide

Oct.2024

Guaranty and Declaration

Copyright

© 2024 RIGOL TECHNOLOGIES CO., LTD. All Rights Reserved.

Trademark Information

RIGOL® is the trademark of RIGOL TECHNOLOGIES CO., LTD.

Notices

- RIGOL products are covered by P.R.C. and foreign patents, issued and pending.
- RIGOL reserves the right to modify or change parts of or all the specifications and pricing policies at the company's sole decision.
- Information in this publication replaces all previously released materials.
- Information in this publication is subject to change without notice.
- RIGOL shall not be liable for either incidental or consequential losses in connection with the furnishing, use, or performance of this manual, as well as any information contained.
- Any part of this document is forbidden to be copied, photocopied, or rearranged without prior written approval of RIGOL.

Product Certification

RIGOL guarantees that this product conforms to the national and industrial standards in China as well as the ISO9001:2015 standard and the ISO14001:2015 standard. Other international standard conformance certifications are in progress.

Contact Us

If you have any problem or requirement when using our products or this manual, please contact RIGOL.

E-mail: service@rigol.com

Website: <http://www.rigol.com>

Section	Description	Page
1	Automotive Ethernet Compliance Test Solution	1
2	Document Overview	2
3	Test Items Supported by Different Standards	3
3.1	Transmitter Output Droop	4
3.2	MDI Output Jitter/Transmit Clock Frequency	6
3.3	Timing Jitter (Master/Slave)	7
3.4	Transmitter Distortion	9
3.5	MDI Return Loss	10
3.6	MDI Mode Conversion Loss	10
3.7	Power Spectral Density	11
3.8	Peak Differential Output	12
3.9	MDI Common Mode Emission	12
4	AETH Function of DS70000	13
4.1	System Settings	13
4.1.1	Protocol Specifications and Signal Rate	14
4.1.2	Signal Type	14
4.1.3	Jitter Test	15
4.1.4	Distortion Test	15
4.1.5	Loss Test	17
4.1.5.1	To Use the VNA Device	18
4.1.5.2	To Use the RSA Device	19
4.2	Test Item	21
4.3	Test Connection	22
4.4	Configuration Menu	23
4.4.1	Measurement Configuration	24
4.4.2	To Preview the Waveform and Launch the Test	25
4.5	Result Export	27
5	Fixture Layout	31
5.1	Breakout Board	31
5.2	Frequency Divider Board	33
5.3	Preamplifier Board	35
5.4	Adaptor Board	35
5.5	Matrix Switching Board	36

6	Test Devices Required	38
7	100Base-T1 (IEEE802.3bw)	40
7.1	100Base-T1 Transmitter Output Droop	40
7.2	100Base-T1 MDI Output Jitter	42
7.3	100Base-T1 Transmit Clock Frequency	43
7.4	100Base-T1 Slave TX_TCLK Jitter (Without the Clock)	44
7.5	100Base-T1 Slave TX_TCLK Jitter (With the Clock)	45
7.6	100Base-T1 Transmitter Distortion (With Disturbing Signal, With Reference Clock)	47
7.6.1	To Calibrate the Disturbing Signal	47
7.6.2	Fixture Calibration	49
7.6.3	Distortion Test	51
7.7	100Base-T1 Transmitter Distortion (With Disturbing Signal, Without Reference Clock)	53
7.8	100Base-T1 Transmitter Distortion (Without Disturbing Signal, With Reference Clock)	55
7.9	100Base-T1 Transmitter Distortion (Without Disturbing Signal, Without Reference Clock)	57
7.10	100Base-T1 Power Spectral Density	58
7.11	100Base-T1 Peak Differential Output	59
7.12	100Base-T1 MDI Return Loss	59
7.12.1	Offline Import	60
7.12.2	Online Configuration	61
7.12.2.1	To Select the Signal Type and Test Item	61
7.12.2.2	S-Parameter Calibration	62
7.12.2.3	Loss Test	65
7.13	100Base-T1 MDI Mode Conversion Loss	66
8	1000Base-T1 (IEEE Std 802.3bp)	67
8.1	1000Base-T1 Master Timing Jitter (Without the Clock)	67
8.2	1000Base-T1 Master Timing Jitter (With the Clock)	68
8.3	1000Base-T1 Slave Timing Jitter (Without the Clock)	70
8.4	1000Base-T1 Slave Timing Jitter (With the Clock)	71
8.5	1000Base-T1 MDI Jitter	72
8.6	1000Base-T1 Transmit Clock Frequency	73
8.7	1000Base-T1 Transmitter Distortion (Without Disturbing Signal, Without Reference Clock)	73
8.8	1000Base-T1 Transmitter Distortion (Without Disturbing Signal, With Reference Clock)	74

8.9	1000Base-T1 Transmitter Distortion (With Disturbing Signal, Without Reference Clock)	75
8.10	1000Base-T1 Transmitter Distortion (With Disturbing Signal, With Reference Clock)	77
8.11	1000Base-T1 MDI Return Loss	78
8.12	1000Base-T1 MDI Mode Conversion Loss	79
8.13	1000Base-T1 Power Spectral Density	81
8.14	1000Base-T1 Peak Differential Output	82
8.15	1000Base-T1 Transmitter Output Droop	82
9	100Base-T1 (Open Alliance TC8)	84
9.1	100Base-T1(ECU) Transmitter Output Droop	84
9.2	100Base-T1(ECU) Transmitter Timing Jitter(Master)	85
9.3	100Base-T1(ECU) Transmit Clock Frequency	85
9.4	100Base-T1(ECU) Power Spectral Density	86
9.5	100Base-T1(ECU) Return Loss	87
9.6	100Base-T1(ECU) MDI Mode Conversion Loss	88
9.7	100Base-T1(ECU) MDI Common Mode Emission	90
9.8	100Base-T1(ECU) Transmitter Distortion	91
10	Appendix	94
10.1	Appendix A: Order Information	94
10.2	Appendix B: Warranty	95

1 Automotive Ethernet Compliance Test Solution

As the automotive industry becomes intelligent and network connected, in-vehicle Ethernet technology is more and more widely used in automobiles, such as entertainment, communication, navigation and assisted driving. To ensure the stability and reliability of these functions, the automotive Ethernet compliance test becomes an important link for the function test and verification.

RIGOL's DS70000 series oscilloscope and the Automotive Ethernet compliance analysis option (DS70000-AENETC) can work with the fixture (TF-AENET-STP) to provide the flexible and convenient test solutions for the Automotive Ethernet compliance analysis.

Technical Advantage

- Support IEEE and OPEN Alliance protocol standards, wide test coverage
 - IEEE 802.3bw, 100BASE-T1, 100 Mbps
 - OPEN Alliance TC8, 100BASE-T1, 100 Mbps
 - IEEE 802.3bp, 1000BASE-T1, 1 Gbps
- Support multiple test scenarios and multiple test items
- Test device connection diagram and test procedures are available on the test operation interface of the oscilloscope, easy for users to follow the instructions to complete the test.
- Support waveform preview, capable of judging whether the previewed waveform is accurate for the test
- Support generating user-defined HTML or PDF test report, with test results and measurement values in it
- Provide the test devices and accessories necessary for the test, as well as the operation guide

2 Document Overview

This document introduces the Automotive Ethernet compliance test, including

- Standard or protocols supported by RIGOL's Automotive Ethernet compliance test;
- DS70000 series oscilloscope automotive Ethernet compliance test;
- Layout of the fixtures in the TF-AENET-STP fixture kits;
- Operation guide on how to perform tests for the automotive Ethernet test items.



TIP

For the latest version of this manual, download it from the official website of RIGOL (<http://www.rigol.com>).

Publication Number

UGM03101-1110

Format Conventions in this Manual

1. Key

The front panel key is denoted by the menu key icon. For example,  indicates the "Default" key.

2. Menu

The menu item is denoted by the format of "Menu Name (Bold) + Character Shading" in the manual. For example, **Test Item** indicates clicking or tapping the "Test Item" tab in the current operation interface to enter the "Test Item" menu.

3. Operation Procedures

The next step of the operation is denoted by ">" in the manual. For example, **AETH > Test Item** indicates that first clicking or tapping **AETH**, then clicking or tapping **Test Item**.

3 Test Items Supported by Different Standards

The series fixture supports the following standards of the Automotive Ethernet compliance analysis test.

- 1000BASE-T1: IEEE Std 802.3bp
- 100BASE-T1: IEEE Std 802.3bw
- 100BASE-T1: OPEN Alliance TC8

The following table lists the test items supported by different standards.

Table 3.1 Test Items Supported by Different Standards

Test Item	100BASE-T1		1000BASE-T1
	IEEE Std 802.3bw	OPEN Alliance TC8	IEEE Std 802.3bp
Transmitter Output Droop	√	√	√
MDI Output Jitter	√	√	√
Transmit Clock Frequency	√	√	√
Master Timing Jitter			√
Slave Timing Jitter	√		√
Transmitter Distortion	√	√	√
MDI Return Loss	√	√	√
MDI Mode Conversion Loss	√	√	√
Power Spectral Density	√	√	√
Peak Differential Output	√		√
MDI Common Mode Emission		√	

3.1 Transmitter Output Droop

Typical Waveform

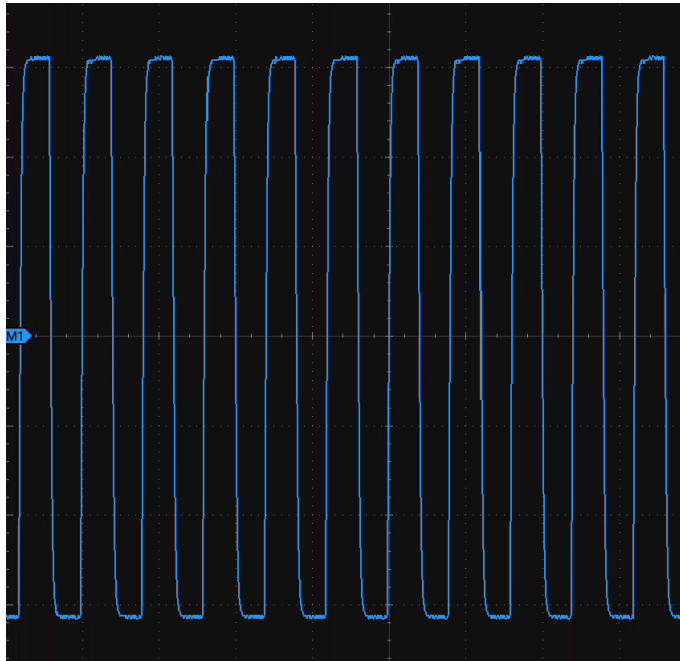

Figure 3.1 Typical Waveform of Transmitter Output Droop

Pass Condition

- **100BASE-T1**

Configure the DUT to Test Mode 1. Measure the magnitude of both the positive and negative droop with respect to the initial peak value after the zero crossing and the value 500 ns after the initial peak.

The formula is as follows:

$$\text{Positive Droop} = (V_d/V_{\text{positive_pk}}) \times 100$$

$$\text{Negative Droop} = (V_d/V_{\text{negative_pk}}) \times 100$$

$V_{\text{positive_pk}}$: indicates the initial voltage peak after the zero crossing of each rising edge; $V_{\text{negative_pk}}$: indicates the initial voltage peak after the zero crossing of each falling edge.

V_d : indicates the voltage droop value 500 ns after the initial peak.

- **1000BASE-T1**

Configure the DUT to Test Mode 6. Measure the magnitude of both the positive and negative droop with respect to the initial peak value 4 ns after the zero crossing and the final value 16 ns after the zero crossing (12 ns period).

The formula is as follows:

$$\text{Positive Droop} = (V_d/V_{\text{positive_pk}}) \times 100$$

$$\text{Negative Droop} = (V_d/V_{\text{negative_pk}}) \times 100$$

$V_{\text{positive_pk}}$: indicates the initial voltage peak after the zero crossing of each rising edge; $V_{\text{negative_pk}}$: indicates the initial voltage peak after the zero crossing of each falling edge.

V_d : indicates the final value 16 ns after the zero crossing (12 ns period).

Table 3.2 Pass Condition

Signal Rate	Test Contents	Pass Conditions
100 MHz	Positive Droop/Negative Droop	<45.00%
1000 MHz	Positive Droop/Negative Droop	<10.00%

Test Graph

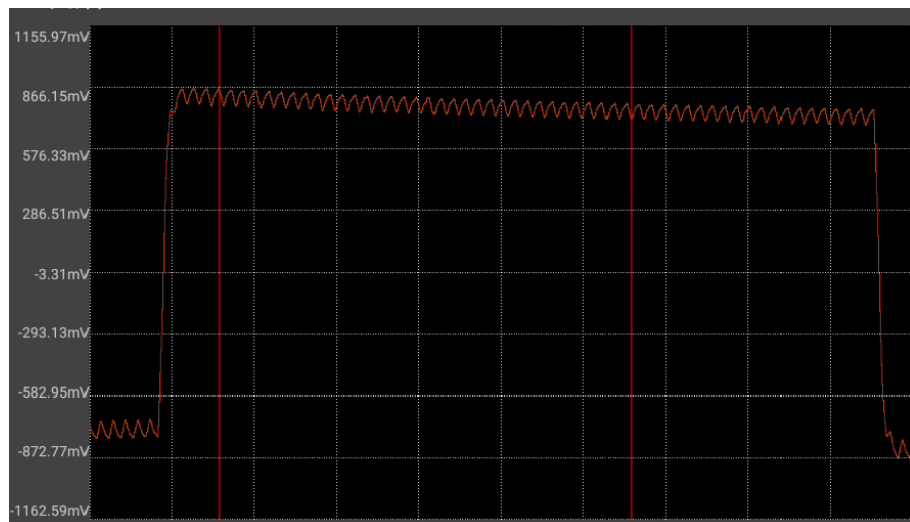

Figure 3.2 100BASE-T1 Positive Droop

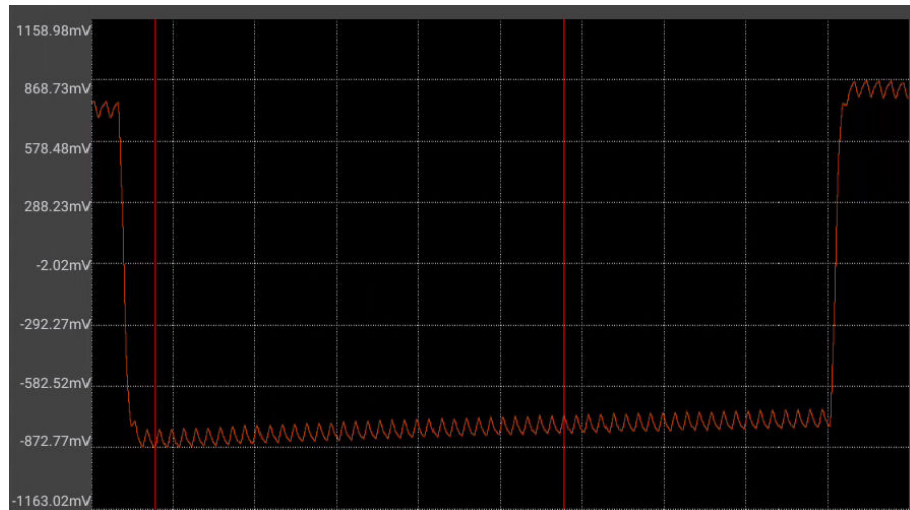

Figure 3.3 1000BASE-T1 Negative Droop

3.2 MDI Output Jitter/Transmit Clock Frequency

Typical Waveform

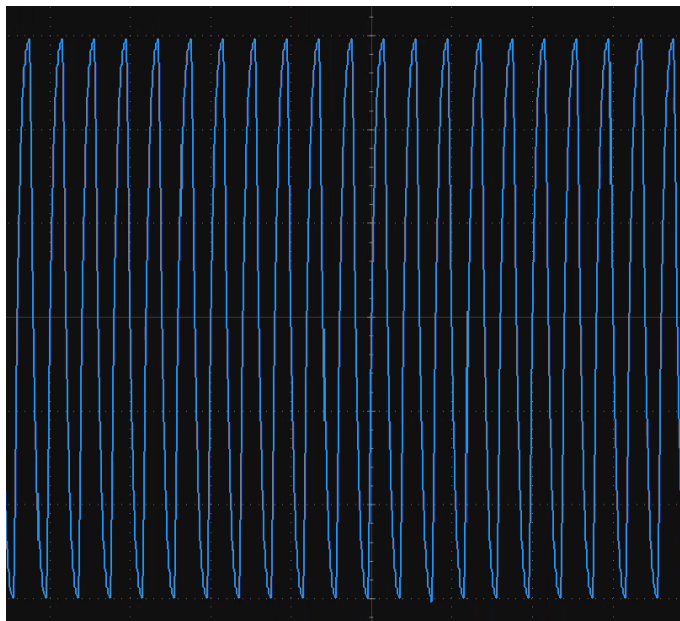

Figure 3.4 Typical Waveforms of the MDI Output Jitter/Transmit Clock Frequency

Pass Condition

Set the DUT as the master; configure the DUT to Test Mode 2; calculate the RMS and peak-to-peak values of the MDI output jitter J_{TXOUT} with recovery clock as a reference.

Table 3.3 Pass Condition for the MDI Output Jitter

Signal Rate	Test Contents	Pass Conditions
100 MHz	J_{TXOUT} (RMS)	<50 ps
1000 MHz	J_{TXOUT} (RMS)	<5 ps
	J_{TXOUT} (Peak-to-Peak)	<50 ps

For 100Base-T, configure the DUT to Test Mode 2. The generated Test Mode 2 signal is a clock signal where the physical layer shall transmit the data symbol sequence (+1,-1) repeatedly on all channels.

For 1000Base-T, configure the DUT to Test Mode 2.

The generated Test Mode 2 signal is a clock signal where the physical layer shall transmit a continuous pattern of three {+1} symbols followed by three {-1} symbols.

For 1000Base-T, 1000BASE-T1 PHY shall provide access to a frequency reduced version of the transmit symbol clock or TX_TCLK125.

Table 3.4 Pass Condition for the Transmit Clock Frequency

Signal Rate	Test Contents	Pass Conditions
100 MHz	F_{min}	66.6603 MHz
	F_{max}	66.6736 MHz
1000 MHz	F_{min}	124.9875 MHz
	F_{max}	125.0125 MHz

3.3 Timing Jitter (Master/Slave)

Typical Waveform

- 100BASE-T1

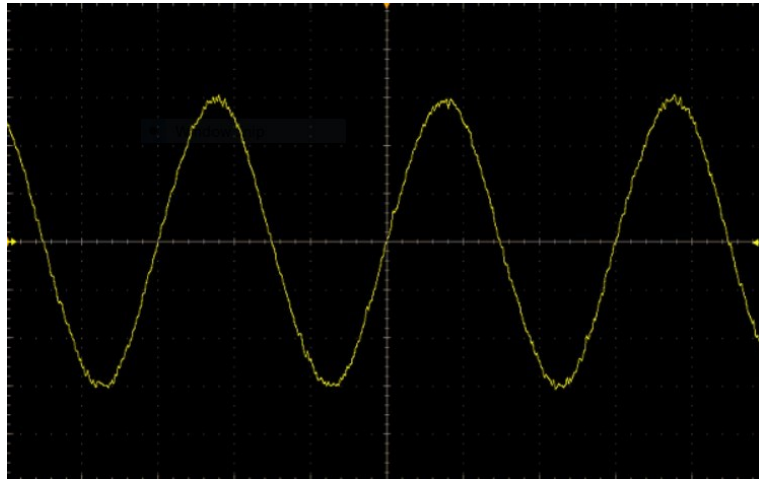

Figure 3.5 Typical Waveform of the Timing Jitter for 100BASE-T1

- **1000BASE-T1**

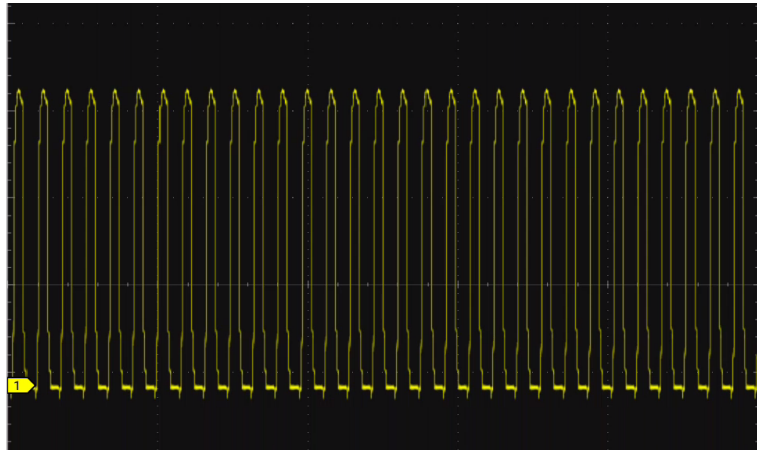

Figure 3.6 Typical Waveform of the Timing Jitter for 1000BASE-T1

Pass Condition

- **100BASE-T1**

Set the DUT as the slave device and make it work normally. Use it to test the RMS jitter of the clock signal (TX_TCLK).

- **1000BASE-T1**

Set the DUT as the master device and slave device respectively. Configure the DUT to Test Mode 1. Perform the jitter test for TX_TCLK125. Calculate the TIE with the jitter. Then calculate the RMS jitter and Peak-to-Peak jitter with the histogram.

Table 3.5 Pass Condition

Signal Rate	Test Contents	Pass Conditions
100 MHz	RMS Jitter	<150 ps
1000 MHz	RMS Jitter	<5 ps
	Peak-to-Peak Jitter	<50 ps
	RMS Jitter	<10 ps
	Peak-to-Peak Jitter	<100 ps

3.4 Transmitter Distortion

Typical Waveform

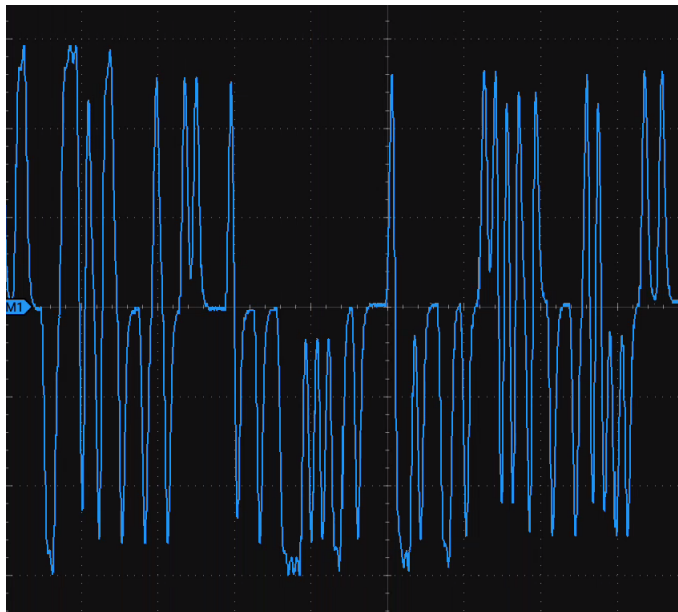

Figure 3.7 Typical Waveform of Transmitter Distortion

Pass Conditions for Transmitter Distortion

When the DUT is in Test Mode 4, test the transmitter distortion of the load and the differential probe under test.

During the transmitter distortion, if the clock signal is available, you need to synchronize the DUT clock signal with that of the oscilloscope and the Function/Arbitrary Waveform Generator. If the clock signal is not available, you need to synchronize the clock signal of the oscilloscope and the Function/Arbitrary Waveform Generator signal.

Table 3.6 Pass Condition

Signal Rate	Test Contents	Pass Conditions
100 MHz	Transmitter Distortion	<15 mV
1000 MHz	Transmitter Distortion	<15 mV

3.5 MDI Return Loss

Refer to [Figure 3.4](#) to acquire the typical waveform of the test signal of the MDI return loss.

Pass Condition

The oscilloscope tests the MDI waveforms transmitted by the DUT and calculates the return loss (loss generated by the reflection arising from the non-continuous impedance in the transmission link). If the test results are compliant with the following formula, the test passes; if not compliant, the test fails.

- **100BASE-T1**

$$MDI \text{ Return Loss}(f) \begin{cases} 20 \text{ dB} & 1\text{MHz} \leq f \leq 30\text{MHz} \\ 20 - 20 \times \log_{10} \frac{f}{30} \text{ dB} & 30\text{MHz} \leq f \leq 66\text{MHz} \end{cases}$$

- **1000BASE-T1**

$$MDI \text{ Return Loss}(f) \begin{cases} 18 - 18 \times \log_{10} \frac{20}{f} \text{ dB} & 2\text{MHz} \leq f < 20\text{MHz} \\ 18 \text{ dB} & 20\text{MHz} \leq f < 600\text{MHz} \\ 18 - 16.7 \times \log_{10} \frac{f}{100} \text{ dB} & 100\text{MHz} \leq f \leq 600\text{MHz} \end{cases}$$

3.6 MDI Mode Conversion Loss

Refer to [Figure 3.4](#) to acquire the typical waveforms of the test signal of the MDI mode conversion loss.

Pass Condition

Use the VNA device or device with the VNA mode to test the LCL (Longitudinal Conversion Loss) value calculated on the MDI interfaces of the DUT in different frequency ranges.

The LCL shall meet or exceed the limit defined in the following equation for all frequencies from 1 MHz to 200 MHz for 100Base-T1 and frequencies from 10 MHz to 600 MHz for 1000Base-T1.

- **100BASE-T1**

$$\text{Conversion Loss } (f) \geq \begin{cases} 50 \text{ dB} & 1\text{MHz} \leq f \leq 33\text{MHz} \\ 50 - 20 \times \log_{10} \frac{f}{33} \text{ dB} & 33\text{MHz} < f \leq 200\text{MHz} \end{cases}$$

- **1000BASE-T1**

$$\text{Conversion Loss } (f) \geq \begin{cases} 55 \text{ dB} & 10\text{MHz} \leq f \leq 80\text{MHz} \\ 77 - 11.51 \times \log_{10} f \text{ dB} & 80\text{MHz} < f \leq 600\text{MHz} \end{cases}$$

3.7 Power Spectral Density

Refer to [Figure 3.4](#) to acquire the test signal of the Power Spectral Density.

Pass Condition

The oscilloscope tests the power spectral density (PSD) of the waveforms sent from the MDI interface of the DUT.

Calculate the upper bound and lower bound of the Power Spectral Density (PSD) within the specified frequency range according to the following formula. It is deemed to "pass the test" if the PSD of the DUT falls between the upper bound and lower bound; if not, it is deemed to "fail the test".

- **100BASE-T1**

$$\text{UpperPSD } (f) \begin{cases} -63.3 - 1.5 \times \frac{f-1}{19} \text{ dBm/Hz} & 1 \text{ MHz} \leq f < 20 \text{ MHz} \\ -64.8 - 3.7 \times \frac{f-20}{20} \text{ dBm/Hz} & 20 \text{ MHz} \leq f < 40 \text{ MHz} \\ -68.5 - 8.0 \times \frac{f}{25} \text{ dBm/Hz} & 40 \text{ MHz} \leq f < 57 \text{ MHz} \\ -76.5 \text{ dBm/Hz} & 57 \text{ MHz} < f \leq 200 \text{ MHz} \end{cases}$$

$$\text{LowerPSD}(f) \begin{cases} -70.9 - 4.9 \times \frac{f-1}{19} \text{ dBm/Hz} & 1 \text{ MHz} \leq f < 20 \text{ MHz} \\ -75.8 - 13.4 \times \frac{f-20}{20} \text{ dBm/Hz} & 20 \text{ MHz} \leq f < 40 \text{ MHz} \end{cases}$$

- **1000BASE-T1**

$$\text{UpperPSD } (f) \begin{cases} -63.3 - 1.5 \times \frac{f-1}{19} \text{ dBm/Hz} & 1 \text{ MHz} \leq f < 20 \text{ MHz} \\ -64.8 - 3.7 \times \frac{f-20}{20} \text{ dBm/Hz} & 20 \text{ MHz} \leq f < 40 \text{ MHz} \\ -68.5 - 8.0 \times \frac{f}{25} \text{ dBm/Hz} & 40 \text{ MHz} \leq f < 57 \text{ MHz} \\ -76.5 \text{ dBm/Hz} & 57 \text{ MHz} < f \leq 200 \text{ MHz} \end{cases}$$

$$LowerPSD(f) \begin{cases} -86 \text{ dBm/Hz} & 40 < f \leq 100 \\ -82 - \frac{f}{25} \text{ dBm/Hz} & 100 < f \leq 400 \end{cases}$$

3.8 Peak Differential Output

Refer to [Figure 3.4](#) to acquire the test signal of the peak differential output.

Pass Condition

When measured with 100Ω termination, this test confirms that the transmitter peak differential output is within the peak-to-peak limits.

Table 3.7 Pass Condition for the Peak Differential Output

Signal Rate	Test Contents	Pass Conditions
100 MHz	Peak Differential Output V_{pp}	<2.2 V
1000 MHz	Peak Differential Output V_{pp}	<1.3 V

3.9 MDI Common Mode Emission

Refer to [Figure 3.4](#) to acquire the test signal of the MDI common mode emission.

Pass Condition

Set the DUT as the master; configure it to Test Mode 5, and test the MDI common mode emission (CME) value of the DUT.

Pass condition: CME value ≤ 24 dBuV (within the range between 1 MHz and 200 MHz)

4 AETH Function of DS70000

DS70000 series oscilloscope supports Automotive Ethernet signal quality compliance analysis. It is available to use when you have purchased the AUTOENTC option and activated the option. For details about the DS70000 series digital oscilloscope, refer to *DS70000 User Guide*.

In the DS70000 operation interface, click or tap  > **AETH** to enter the "Automotive Ethernet Test" menu.

4.1 System Settings

In the "Automotive Ethernet Test" interface, click or tap **System Settings** to enter the system settings menu. You can select the desired specification and signal rate, make configurations for different test schemes.

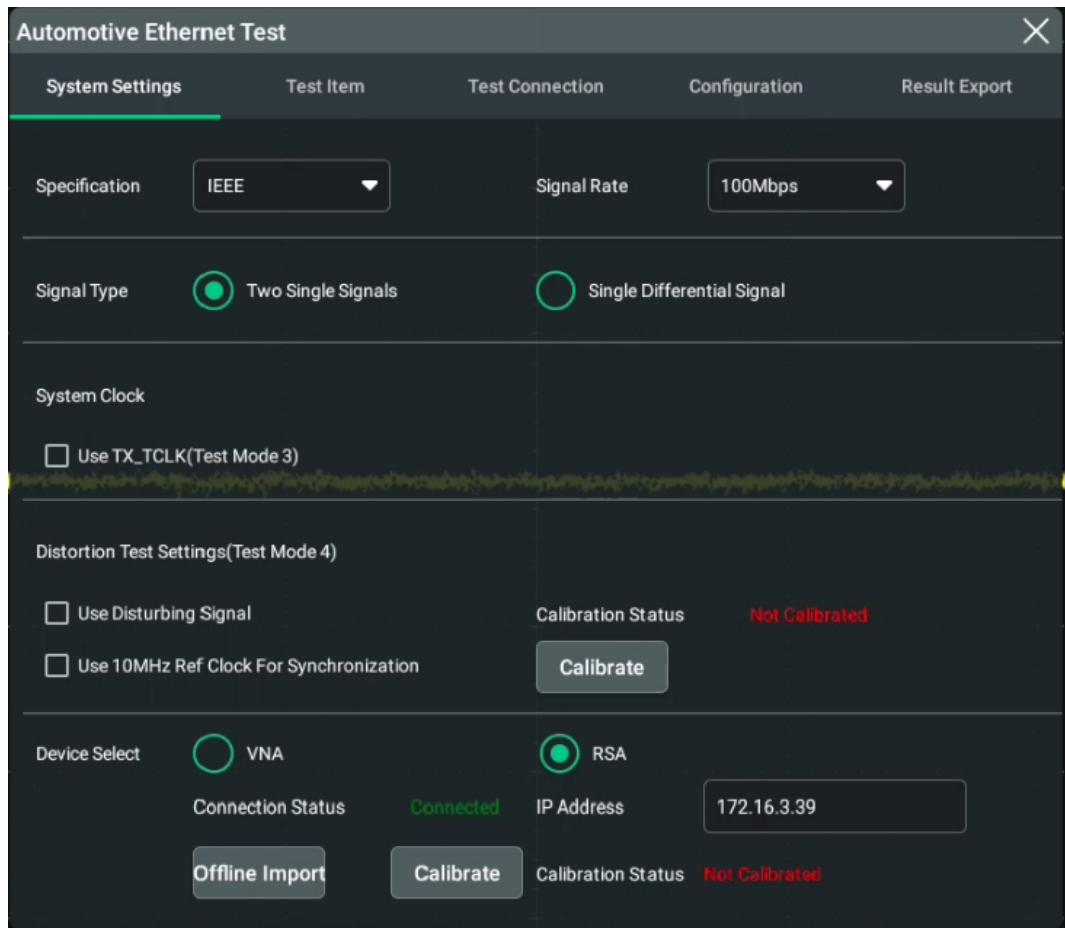

Figure 4.1 System Settings of the Automotive Ethernet Test

4.1.1 Protocol Specifications and Signal Rate

Select the protocol specifications and the signal rate.

- If you select "IEEE", the available signal rate is "100Mbps" or "1000Mbps".
- If you select "Open Alliance", the available signal rate is "100 Mbps".

4.1.2 Signal Type

The signal under test includes two types.

- **Two Single Signals:** The signal under test can be converted into two single-ended signals through the fixture. Connect the Dp and Dn terminals to the two respective channels of the oscilloscope.
- **Single Differential Signal:** The signal under test can be converted into a single differential signal through the fixture. Connect the signal to the one of the channels of the oscilloscope.

The following test items in the Automotive Ethernet Test only support one of the signal type to be connected to the oscilloscope to perform the test. Except the following test items, other test items support both of the two signal types.

- The following test items only support "Two Single Signals" being connected to the oscilloscope.
 - Transmitter Distortion
 - MDI Return Loss
 - MDI Mode Conversion Loss
- The following test items only support "Single Differential Signal" being connected to the oscilloscope.
 - MDI Output Jitter(Master)
 - Timing Jitter (Master/Slave)
 - Power Spectral Density
 - MDI Common Mode Emission

4.1.3 Jitter Test

For the timing jitter test, different test scenarios are supported. You can determine whether to involve the clock signal or the filter.

System Clock

- If the device under test (DUT) can output the clock signal via the TX_TCLK interface, you can use this clock signal to perform the jitter test.
- If the DUT only supports outputting MDI signal and does not support outputting the clock signal, then do not select "Use TX_TCLK".

Band Pass Filter

Specification "IEEE", Signal Rate "1000Mbps": When performing the jitter test, check the checkbox of "2MHz Bandpass Filter".

When you choose to check the checkbox of "2MHz Bandpass Filter" to filter the test signal, the signal noise can be reduced and the test results are optimized.

4.1.4 Distortion Test

The distortion test can be performed in the following four test scenarios. The test schemes for different test scenarios are different.

- Without disturbing signal, without reference clock signal
- Without disturbing signal, with reference clock signal
- With disturbing signal, without reference clock signal
- With disturbing signal, with reference clock signal

In the **System Settings** menu, you can configure for the above four test scenario settings by checking or unchecking the checkbox of "Use Disturbing Signal" and "Use 10 MHz Ref Clock For Synchronization".

Calibrate the Disturbing Signal Source

Before performing the distortion test for the scenario with the disturbing signal, perform calibration for the disturbing signal and the fixture first.

Click or tap **Calibrate** to enter the DUT Calibration interface, as shown in the figure below.

Disturbing Signal		
	Expected Value	Measured Value
Frequency	125MHz	
Level	1.8V	

Fixture Calibration		
	Expected Value	Measured Value
Pre-attenuation	2.22V	
Post-attenuation	1.8V	
Attenuation	1.5	

Buttons: < Back, Apply, > Connection Diagram

- **Connection Diagram**

In the "DUT Calibration" interface, click or tap **Connection Diagram** to enter the Connection Diagram interface. The Connection Diagram interface shows the calibration connection diagram for the disturbing signal. Below the diagram are the calibration procedures. You can drag up and down the page to view the complete information.

Click or tap **Back** to return to the DUT Calibration interface.

- **Disturbing Signal**

The Expected Value shows the ideal frequency and amplitude value of a disturbing signal.

Connect the device for calibrating the disturbing signal according to the connection diagram, then perform the test according to the test procedures. Click or tap **Measure** to start testing for the actual disturbing signal. After completing the test, the measured frequency and amplitude values of the disturbing signal are displayed in the "Measured Value" field.

Compare the measured value and the expected value. If they are not close to each other, modify the amplitude and frequency of the disturbing signal to test again until they are approximately equivalent.

If the disturbing signal does not need to be calibrated, click or tap **Default**, and the expected value will be used as the measured value of the disturbing signal.

- **Fixture Calibration**

The Expected Value field shows the ideal measured values of the pre-attenuation amplitude, post-attenuation amplitude, and amplitude attenuation.

Connect the device for calibrating according to the connection diagram, then perform the test according to the test procedures. Click or tap **Measure** to start testing. After completing the test, the measured pre-attenuation amplitude, post-attenuation amplitude, and amplitude attenuation are displayed in the "Measured Value" field.

If the fixture does not need to be calibrated, click or tap **Default**, and the expected value will be used as the measured value.

- **Apply**

After completing the test for the disturbing signal and the fixture, click or tap **Apply** to complete the calibration configuration for the disturbing signal and the fixture.

- **Back**

Click or tap **Back** to return to the "System Settings" menu.

Calibration Status

- Before calibration, the calibration status shows, by default, "Not Calibrated".
- After calibration, the calibration status shows "Calibration completed!"

4.1.5 Loss Test

The loss test includes the MDI Return Loss and MDI Mode Conversion Loss. You can perform the loss test with DS70000 in the following two test scenarios.

- **Vector Network Analyzer (VNA)**

Use a VNA device to perform the loss test. Then export the measurement data generated from the VNA device to the oscilloscope to perform the compliance analysis. Generate the analysis report.

- **Use the real-time spectrum analyzer with VNA function.**

RIGOL's RSA3000N series spectrum analyzer is recommended.

- **Online configuration:** Build network connection between the oscilloscope and the spectrum analyzer. Then control the spectrum analyzer to complete the calibration and measurement operation through the oscilloscope. After

finishing the measurement, the oscilloscope reads the measurement data, makes an analysis, and generates the analysis report.

- **Offline import:** Use the VNA mode of the RSA3000N series spectrum analyzer to perform the loss test. Import the measurement data generated from the spectrum analyzer to the oscilloscope offline to perform the compliance analysis. Then generate the analysis report.

Select the test scheme based on the actual situation of the test device.

4.1.5.1 To Use the VNA Device

In the "System Settings" tab, select **VNA** under **Device Select**.

Click or tap **Offline Import**, then the "Offline Import" interface is displayed, as shown in the figure below.

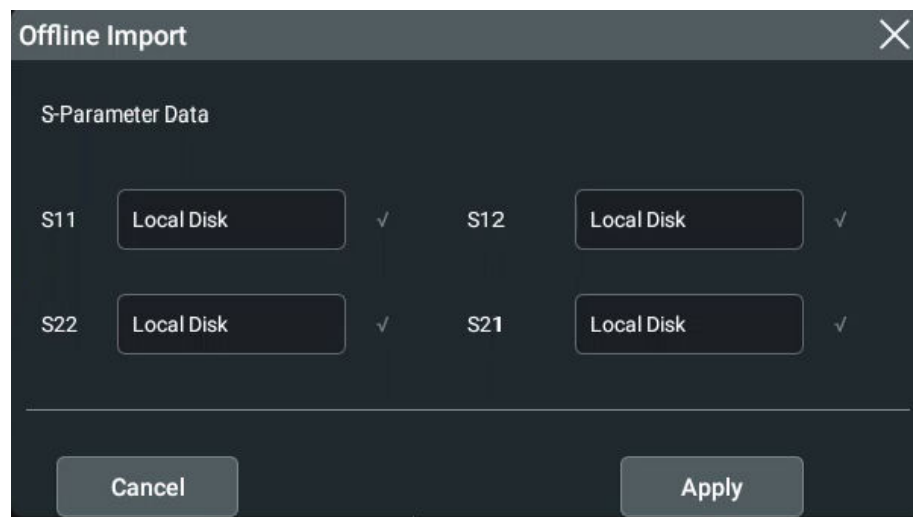

Figure 4.2 Offline Import Interface

Click or tap the input field of **S11**, **S12**, **S22**, and **S21** respectively, then select the desired data file from the specified path in "Disk Management" interface. Then the file is imported. If successfully imported, the tick icon (✓) following the input field of **S11**, **S12**, **S22**, or **S21** turns out to be green. The format of the imported measurement data is "*.s1p" (for S11 measurement) or "*.s2p" (for S21 measurement).

After importing all the S-parameter data, click or tap **Apply** to apply the data import. Then the measurement analysis report is generated.

4.1.5.2 To Use the RSA Device

To perform the loss test, use RIGOL's RSA3000N series spectrum analyzer (equipped with the VNA mode) to work with the oscilloscope.

Online Configuration

In the "System Settings" tab, select **RSA** under **Device Select**.

1. Connect the RSA device

Click or tap the input field of **IP Address** to input the IP address of the RSA device. If connected successfully, the **Connection Status** shows "Connected".

2. Calibrate the RSA device

Click or tap **calibrate**, then "S-Parameter Test" interface is displayed, as shown in the figure below.

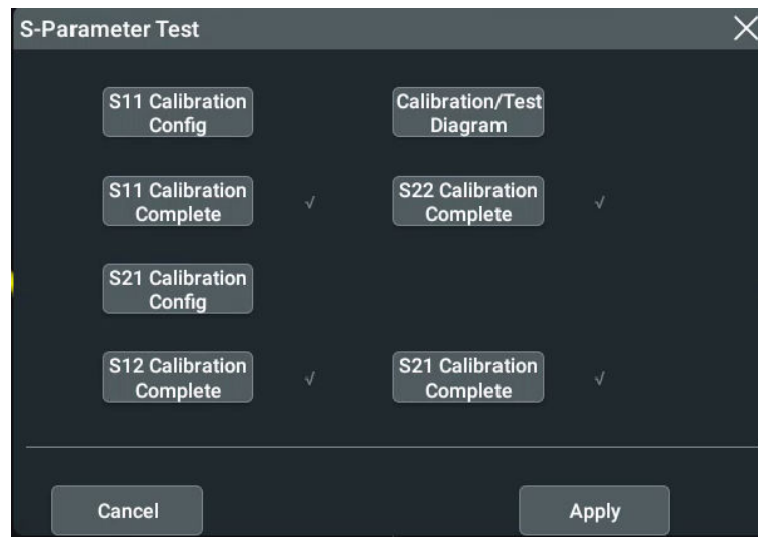

Figure 4.3 S-Parameter Test

- a. Click or tap **Calibration/Test Diagram**, then the "Calibration/Test Diagram" interface is displayed, showing the calibration connection diagram and the calibration operation procedures, as shown in the figure below.

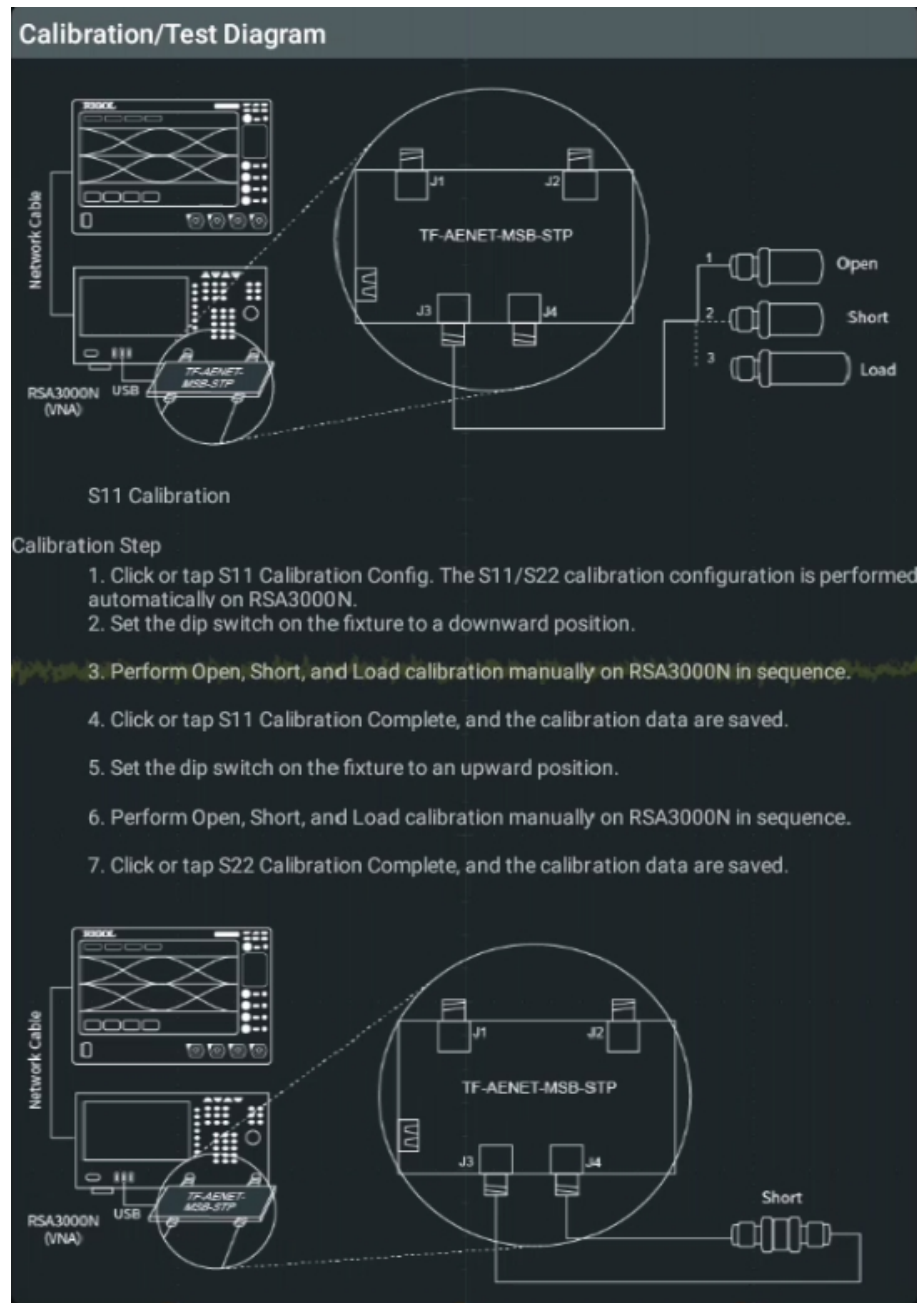

Figure 4.4 Calibration Connection Diagram and Calibration Procedure

- b. Connect the test devices for S11 Calibration test according to the connection diagram. Click or tap **S11 Calibration Config**, the S11/S22 calibration configuration is performed automatically on the RSA device. Then calibrate S11 parameter of RSA device according to the calibration procedure shown above. The calibration procedure for S22 is the same as that for S11. Click or tap **S11 Calibration Complete** and **S22 Calibration Complete** respectively to save the calibration data of S11 and S22 to the oscilloscope. After the

calibration is completed, the tick icon ✓ following the specified calibration turns green.

- c. Connect the test devices for S21 Calibration test according to the connection diagram. Click or tap **S21 Calibration Config**, the S21/S12 calibration configuration is performed automatically on the RSA device. Then calibrate S21 parameter of RSA device according to the calibration procedure shown above. The calibration procedure for S12 is the same as that for S21. Click or tap **S12 Calibration Complete** and **S21 Calibration Complete** respectively to save the calibration data of S12 and S21 to the oscilloscope. After the calibration is completed, the tick icon ✓ following the specified calibration turns green.
- d. Click or tap **Apply** to complete the S-parameter calibration.

After completing the system settings and selecting the specified test item, start to launch the loss test. For detailed operations, refer to *To Preview the Waveform and Launch the Test*. After finishing the test, the instrument generates the analysis report.

Offline Import

The test method for the offline import is the same as using the VNA device. For details, refer to *To Use the VNA Device*.

4.2 Test Item

After selecting the specification and signal rate, click or tap **Test Item** in the "Automotive Ethernet Test" interface to enter the test item menu, as shown in the figure below.

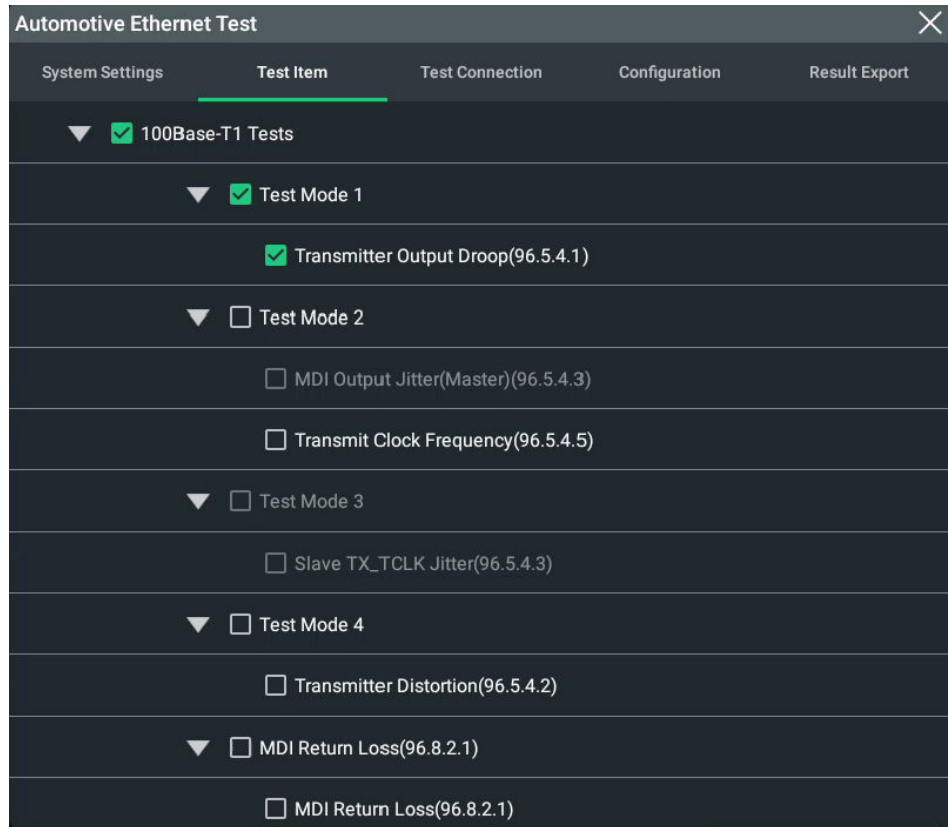





Figure 4.5 Test Item

Click or tap the icon  to unfold all the sub-items. Click or tap to check the checkbox . When it turns out be , the specified test item is selected.

The test items for different signal types are different. Refer to *Test Items Supported by Different Standards* for details.

4.3 Test Connection

After selecting the test item and configuring the parameters, click or tap **Test Connection** to view the diagram of the current test connection, as shown in the following figure. The **Test Connection** menu shows the connection methods for the specified test item and the corresponding test procedures, guiding you to perform the test.

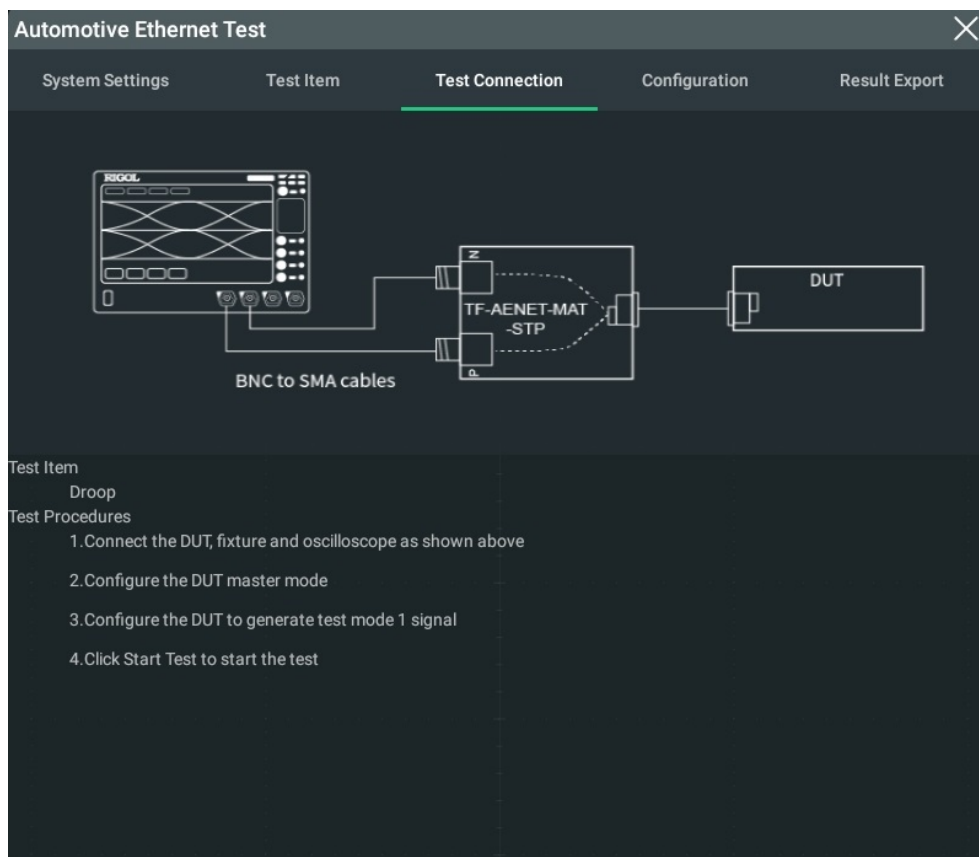

Figure 4.6 Test Connection and Test Procedures

4.4 Configuration Menu

After selecting a test item, click or tap the **Configuration** tab to enter the Configuration menu, as shown in the following figure.

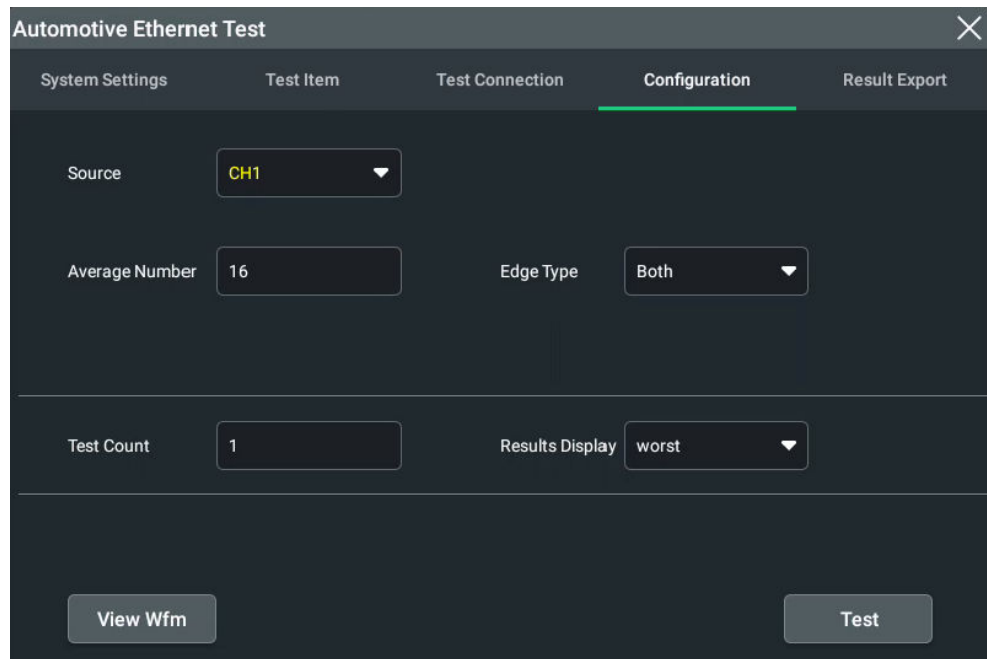

Figure 4.7 Configuration Menu for Single Differential Signal

4.4.1 Measurement Configuration

Click or tap the Configuration tab to enter the measurement setting interface where you can configure the relevant parameters for the measurement.

Signal Source

In *Signal Type*, it introduces how to connect two signal types to the oscilloscope respectively.

- **Two Single Signals:** selects the channel of the oscilloscope for "Dp Source" and "Dn Source" respectively to which the signal under test is connected.
- **Single Differential Signal:** selects the channel of the oscilloscope for "Source" to which the signal under test is connected.

The source configuration shall be consistent with the source of the actually connected device under test (DUT).

TIP

When you select "Two Single Signals" as the signal type, CH1 and CH3 are recommended for "Dp Source" and "Dn Source" respectively; also you can select CH2 and CH4. However, CH2 and CH3 are not recommended, as this will affect the sample rate, eventually affecting the measurement results.

Average Number

Click or tap the input field of **Average Number**, then the numeric keypad is displayed. Input a number for the averaging times when the acquisition mode is Average. Its range is from 2 to 128. Its default value is 16.

Edge Type

Selects the signal edge type ("Rising", "Falling", or "Both") on which the Automotive Ethernet measurement is performed based on the quality of the signal under test. If the signal quality is good, "Both" is, by default, selected.

Test Count

Indicates the number of test times for the oscilloscope to perform the test consecutively. The maximum test count is 10. By default, it is 1. After setting the test count, the oscilloscope will perform the specified times of tests when you click or tap **Test**.

Result Display

After completing the test, you can select to display the test results in three forms in the test result display window.

- **Worst:** displays the worst test results among multiple tests. If the latest test result is better than the existing test result, the existing test result prevails and will not be overwritten by the better result.
- **Best:** displays the best test results among multiple tests. If the latest test result is worse than the existing test result, the existing test result prevails and will not be overwritten by the worse result.
- **Last:** displays the last test result.

For the display effects of the test results, refer to *Figure 4.10*.

4.4.2 To Preview the Waveform and Launch the Test

After completing the system setting, test item selection, test device connection, and test configuration, you can preview the current test waveform and launch the test for the specified test item in the "Configuration" tab.

Preview the Waveform

Click or tap **View Wfm** to preview the waveform for the specified test item in the waveform view to ensure that the waveform is properly output. Check whether the waveform is properly output for the signal under test. If yes, start to launch the test.

Launch the Test

Once previewing the waveform and confirming that the signal under test is properly output, click or tap **Test** to launch the test for the specified test item of the Automotive Ethernet Test.

During the test for the specified item, a prompt message will be displayed, guiding you to perform the corresponding operation. After finishing the test, the instrument generates the analysis report.

Launch the Test for Multiple Test Items at a Time

Multiple test items can be tested at a time. The operation procedures are as follows:

1. Select multiple test items under the "Test Item" menu. Click or tap **Test** to start testing the items in sequence.
2. During the test, each time one test item is completed, the "Connection Change Hint" interface is displayed, prompting you whether to start testing for the next test item. The test item, connection diagram, and the test procedures are displayed.

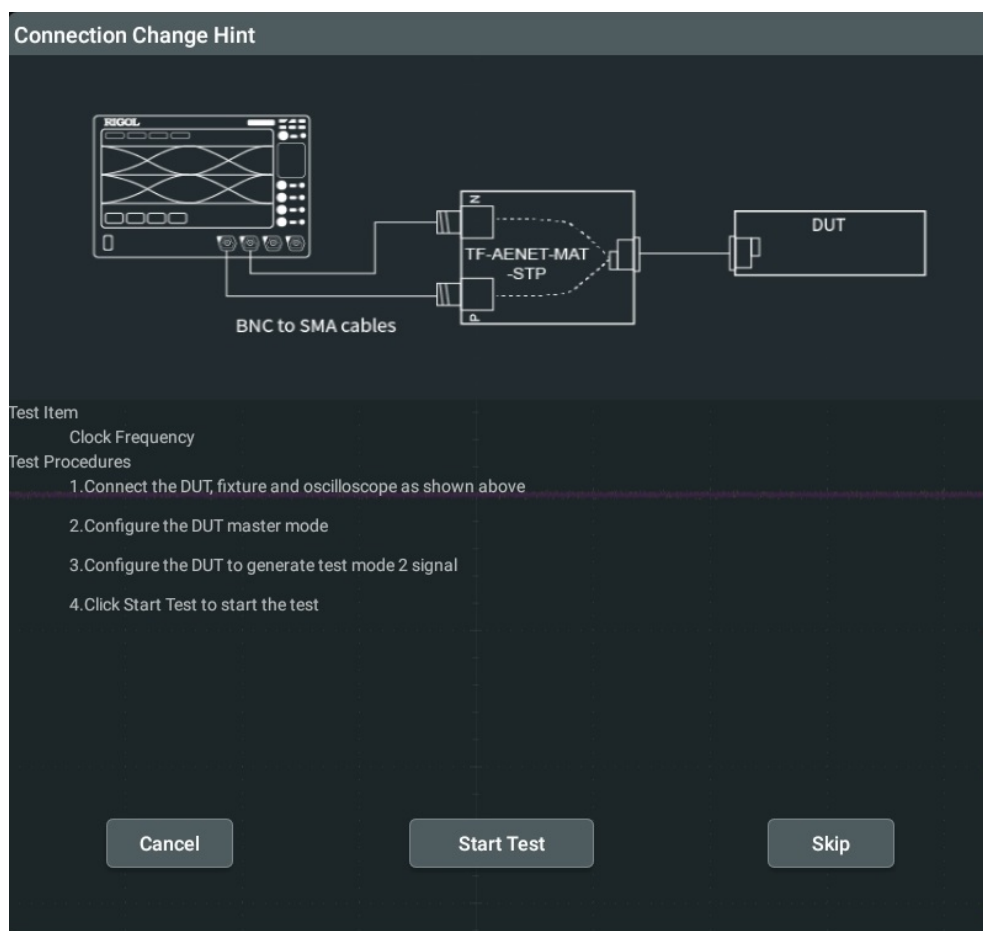

Figure 4.8 Connection Change Hint

3. After completing the connection according to the displayed connection diagram and test procedures, click or tap **Start Test** to start testing the test item.

Click or tap **Cancel** to cancel the current test. Click or tap **Skip** to skip over the current test item and go to test the next test item.

4.5 Result Export

This instrument allows you to view and save the test result report, and download it to the local path. In the "Automotive Ethernet Test" interface, click or tap **Result Export** to enter the result export menu.

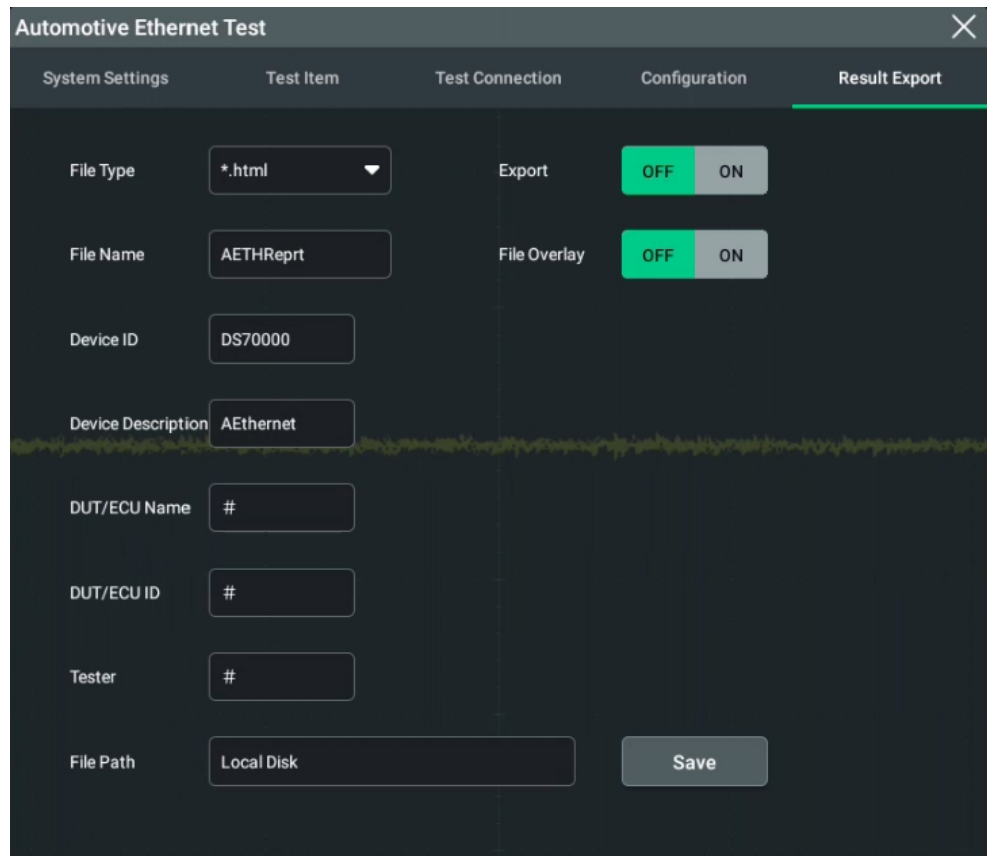

Figure 4.9 Result Report Menu

Enable or Disable the Display of the Report

Click or tap the ON/OFF button for the **Export** menu to enable or disable the display of the analysis report. When enabled, the test report results as shown in the figure below are displayed at the right section of the screen.

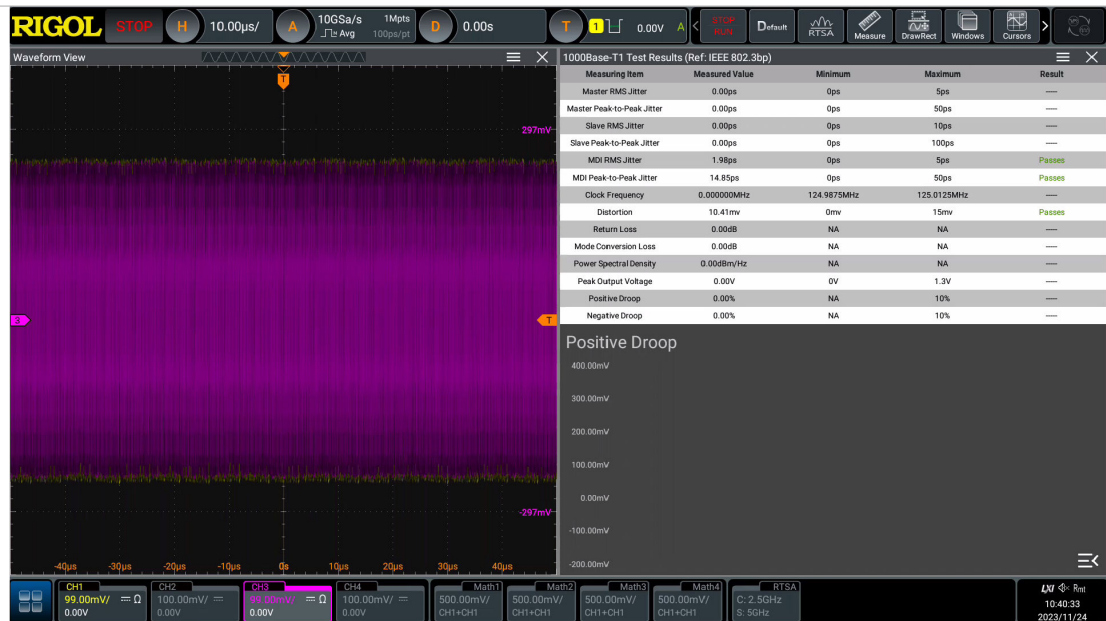

Figure 4.10 Automotive Ethernet Test Conclusion

File Overlay

Click or tap the ON/OFF button for the **File Overlay** menu to enable or disable the overwriting function. When enabled, the existing file in the specified file path will be overwritten by the newly saved file that has the same filename as the existing one.

File Type

Click or tap the drop-down button of **File Type** to select "*.html" or "*.pdf" as the file type of the analysis report.

File Name

Click or tap the input field of **File Name** to input the file name to be saved with the pop-up virtual keypad.

Measurement Information

Input the test information for the following items and they will be displayed in the generated test analysis report.

- Device ID: indicates the name of the oscilloscope to be used.
- Device Description: indicates the description of the oscilloscope to be used.
- DUT/ECU Name: indicates the name of the device under test (DUT) or ECU to be used.
- DUT/ECU ID: indicates the ID of the device under test (DUT) or ECU to be used.

- Tester: indicates the tester name or employee ID.

File Path

When you click or tap the input field of **File Path**, then the disk management interface is displayed. Select the desired location to save the analysis report.



NOTE

You can input a string of characters into the input field of the specified test information with the virtual keypad. You are allowed to input a maximum of 64 characters, and they can be numbers, letters, or special symbols.

5 Fixture Layout

The test fixtures for the Automotive Ethernet Test are listed below. They are used for different test items.

- Breakout Board: TF-AENET-MB-STP
- Adaptor Board: TF-AENET-MAT-STP, TF-AENET-PAD-STP, and TF-AENET-MTD-STP
- Preamplifier Board: TF-AENET-PAB-STP
- Frequency Divider Board: TF-AENET-FDB-STP
- Matrix Switching: TF-AENET-MSB-STP

5.1 Breakout Board

The layout of the test fixture TF-AENET-MB-STP (breakout board) is shown in the following figure. It has four sections:

- Test Section1: not available temporarily
- Test Section2: used for the distortion test
- Test Section3: used for the power spectral density and peak differential output tests
- Test Section4: used for the common mode test

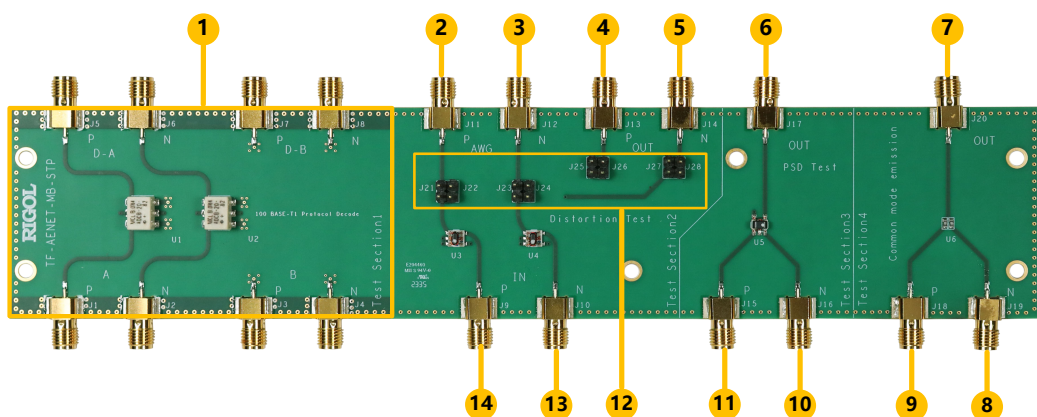

Table 5.1 TF-AENET-MB-STP Layout Description

No.	Pin Name	Description
1	-	N/A
2	J11	SMA interface on Test Section 2, used to connect the Function/Arbitrary Waveform Generator. It is the Dp source of the differential signal sent from the DUT.
3	J12	SMA interface on Test Section 2, used to connect the Function/Arbitrary Waveform Generator. It is the Dn source of the differential signal sent from the DUT.
4	J13	SMA interface on Test Section 2, used to connect the digital oscilloscope. It is the Dp source of the differential signal sent from the DUT.
5	J14	SMA interface on Test Section 2, used to connect the digital oscilloscope. It is the Dn source of the differential signal sent from the DUT.
6	J17	SMA interface on Test Section 3, used to connect the digital oscilloscope.
7	J20	SMA interface on Test Section 4, used to connect the digital oscilloscope.
8	J19	SMA interface on Test Section 4, used to connect the DUT. It is the Dn source of the differential signal sent from the DUT.
9	J18	SMA interface on Test Section 4, used to connect the DUT. It is the Dp source of the differential signal sent from the DUT.
10	J16	SMA interface on Test Section 3, used to connect the DUT. It is the Dn source of the differential signal sent from the DUT.

No.	Pin Name	Description
11	J15	SMA interface on Test Section 3, used to connect the DUT. It is the Dp source of the differential signal sent from the DUT.
12	J21, J22, J23, J24, J25, J26, J27, and J28	2-Pin gold socket x2, short contact points for distortion test on Test Section 2.
13	J10	SMA interface on Test Section 2, used to connect the DUT. It is the Dn source of the differential signal sent from the DUT.
14	J9	SMA interface on Test Section 2, used to connect the DUT. It is the Dp source of the differential signal sent from the DUT.

5.2 Frequency Divider Board

The layout of the test fixture TF-AENET-FDB-STP (frequency divider board) is shown in the following figure.

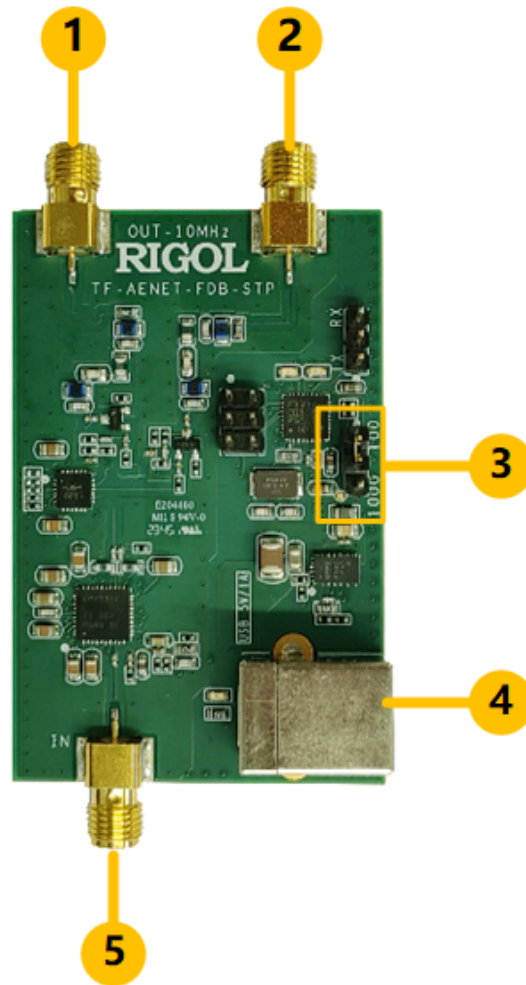

Table 5.2 TF-AENET-FDB-STP Layout Description

No.	Description
1	SAM interface, used to output the 10 MHz Out Reference Clock signal
2	SAM interface, used to output the 10 MHz Out Reference Clock signal
3	3-Pin gold socket, short the socket to control the reference clock signal used for the 100Base-T1 or 1000Base-T1 distortion test
4	USB(F) connector, used to connect the power source
5	SMA interface, used to connect the clock signal TX_TCLK port of the DUT

5.3 Preamplifier Board

The layout of the test fixture TF-AENET-PAB-STP (matrix switching) is shown in the following figure.

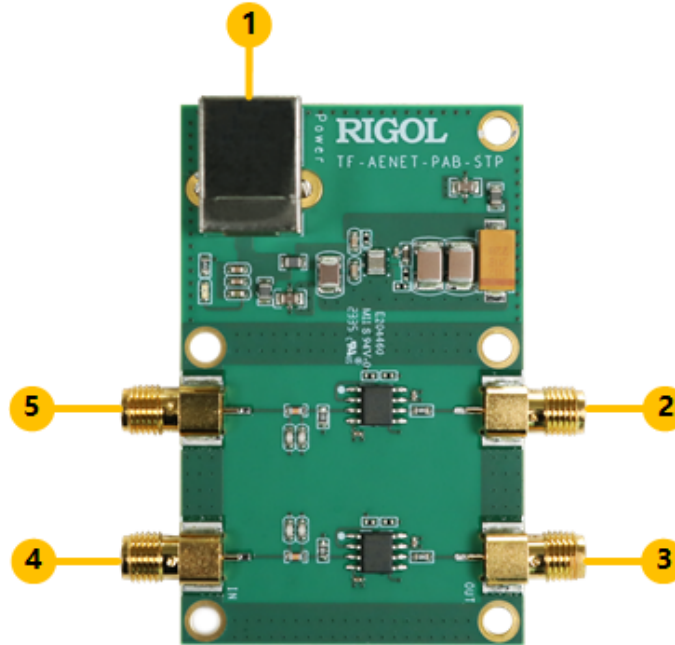

Table 5.3 TF-AENET-PAB-STP Layout Description

No.	Description
1	USB(F) connector, used to connect the power source
2	SMA interface, used to connect the breakout board
3	SMA interface, used to connect the breakout board
4	SMA interface, used to connect the disturbing signal
5	SMA interface, used to connect the disturbing signal

5.4 Adaptor Board

Three adaptor boards are available for the Automotive Ethernet Test.

Adaptor Board Model	MDI Interface
TF-AENET-MAT-STP	MATenet Interface
TF-AENET-PAD-STP	Welding Adaptor

Adaptor Board Model	MDI Interface
TF-AENET-MTD-STP	H-MTD Interface

The layouts of the three adaptor boards are similar, but the MDI interface is different. Take TF-AENET-MAT-STP as an example. The layout of the fixture TF-AENET-MAT-STP is shown in the figure below.

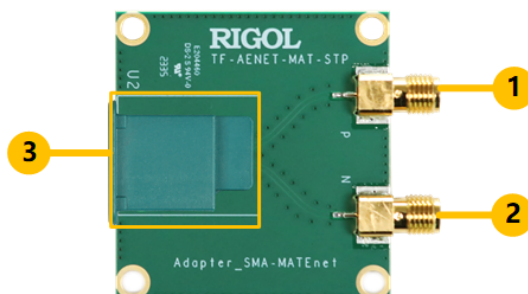

Figure 5.1 TF-AENET-MAT-STP

Table 5.5 TF-AENET-MAT-STP Layout Description

No.	Description
1	SMA interface. It is the Dp source of the differential signal sent from the DUT.
2	SMA interface. It is the Dn source of the differential signal sent from the DUT.
3	MATeNet interface, used to connect the DUT.

5.5 Matrix Switching Board

The layout of the test fixture TF-AENET-MSB-STP (matrix switching) is shown in the following figure.

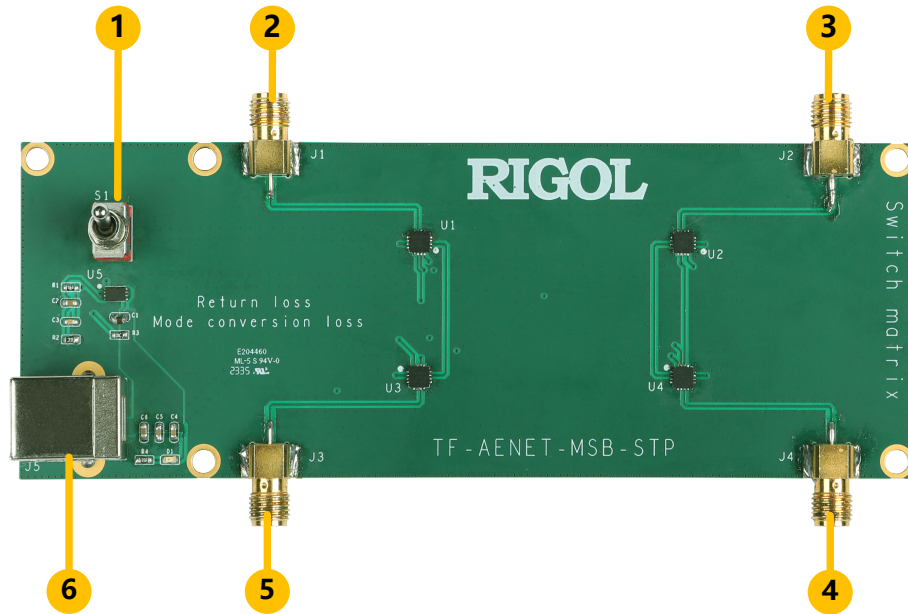

Table 5.6 TF-AENET-MSB-STP Layout Description

No.	Pin Name	Description
1	J1	SMA interface, used to connect the RSA device
2	J2	SMA interface, used to connect the RSA device
3	J4	SMA interface, used to connect the adaptor board
4	J3	SMA interface, used to connect the adaptor board
5	J5	USB(F) connector, used to connect the power source

6 Test Devices Required

Before performing the Automotive Ethernet compliance test, prepare the following test devices.

Table 6.1 Test Tool List

Device	Description
Digital Oscilloscope	Supports the Automotive Ethernet compliance test Recommended DS70000 Series Digital Oscilloscope
Function/Arbitrary Waveform Generator	Generates the disturbing signal required for the test. Recommended Function/Arbitrary Waveform Generator model: RIGOL's DG4000 Series Function/Arbitrary Waveform Generator.
Spectrum Analyzer	Supports the VNA mode. Recommended spectrum analyzer: RIGOL's RSA3000N series spectrum analyzer
VNA Calibration Kit	CK106A and CK106E system calibration kits: Open, Short, and Load.
Low Pass Filter	TF-AENET-FB-STP, used for distortion test.

The following table lists the specifications required for the test devices.

Table 6.2 Specifications Required for the Test Devices

Device	Protocol	
	100Base-T1	1000Base-T1
Digital Oscilloscope	Min. 1 GHz Bandwidth, 2CH	Min. 2 GHz Bandwidth, 2CH
Differential Probe	Min. 1 GHz Bandwidth	Min. 2 GHz Bandwidth
Function/Arbitrary Waveform Generator	Min. 12 MHz Bandwidth, 2CH Single-ended: 5.4 Vpp; Differential: 2.7 Vpp	Min. 125 MHz Bandwidth, 2CH Single-ended: 3.6 Vpp; Differential: 1.8 Vpp

Device	Protocol	
	100Base-T1	1000Base-T1
VNA	Frequency range: 1 MHz to 66 MHz 2-Port	Frequency range: 2 MHz to 600 MHz 2-Port

The following table lists the test devices required for the test items compliant with the of the IEEE Std 802.3bp, IEEE Std 802.3bw, and OPEN Alliance TC87 standards of the Automotive Ethernet Compliance Test.

Table 6.3 Test Devices Required for the Specified Test Items

Test Item	Test Devices Required			
	Digital Oscilloscope	Function/Arbitrary Waveform Generator	VNA	Fixture
Transmitter Output Droop	√			√
Master Timing Jitter	√			√
Transmit Clock Frequency	√			√
Slave Timing Jitter	√			√
Transmitter Distortion	√	√		√
MDI Mode Conversion Loss	√		√	√
MDI Return Loss	√		√	√
Power Spectral Density	√			√
Peak Differential Output	√			√
MDI Common Mode Emission	√			√
MDI Output Jitter	√			√

7 100Base-T1 (IEEE802.3bw)

The following table shows the test modes and test items under each test mode and their reference standards.

Table 7.1 IEEE802.3bw 100Base-T1 Test Item

Test Mode	Test Contents	Reference Standard
Test Mode 1	Transmitter Output Droop	IEEE 802.3bw-2015 96.5.4.1
Test Mode 2	MDI Output Jitter	IEEE 802.3bw-2015 96.5.4.3
	Transmit Clock Frequency	IEEE 802.3bw-2015 96.5.4.5
Test Mode 3	Slave Timing Jitter	IEEE 802.3bw-2015 96.5.4.3
Test Mode 4	Transmitter Distortion	IEEE 802.3bw-2015 96.5.4.2
	MDI Return Loss	IEEE 802.3bw-2015 96.7.1.3
	MDI Mode Conversion Loss	IEEE 802.3bw-2015 96.8.2.2
Test Mode 5	Power Spectral Density	IEEE 802.3bw-2015 96.5.4.4
	Peak Differential Output	IEEE 802.3bw-2015 96.5.6

7.1 100Base-T1 Transmitter Output Droop

For 100Base-T1 Test Mode 1 Transmitter Output Droop, use the test fixture TF-AENET-MAT-STP (adaptor board) and the test fixture TF-AENET-MB-STP Section3 (breakout board) to perform the droop test. This section introduces the test by taking RIGOL DS70000 series oscilloscope as an example.

Select the Signal Type and Test Item

1. In the DS70000 operation interface, click or tap  > **AETH** to enter the "Automotive Ethernet Test" menu.
2. Click or tap **System Settings** to enter system setting menu.
 - Click or tap to select **IEEE** as the specification, and **100Mbps** as the signal rate.

- Click or tap to select **Two Single Signals** or **Single Differential Signal** for the signal type.
3. Click or tap **Test Item** > **100Base-T1 Tests** > **Test Mode 1** > **Transmitter Output Droop** to select the Transmitter Output Droop test.

Connect the Device

For different signal types, the test connection diagrams are different.

- Single Differential Signal

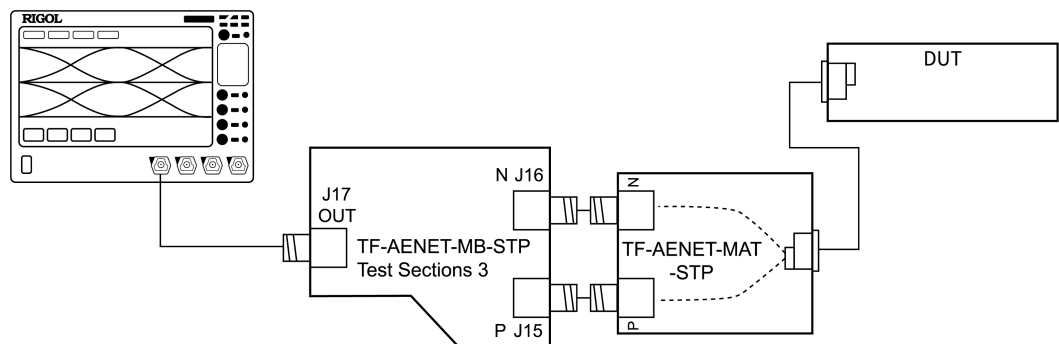

Figure 7.1 Test Connection Diagram for the Single Differential Signal

- Connect the DUT to the MDI interface of the fixture adaptor board by using the network cable.
 - Connect Port P and Port N of the TF-AENET-MB-STP Section3 to that of the TF-AENET-MAT-STP fixture by using the SMA adaptor.
 - Connect Port J17 OUT of TF-AENET-MB-STP Section3 to the analog channel CH1 of the oscilloscope by using the BNC-to-SMA cable.
- Two Single Signals

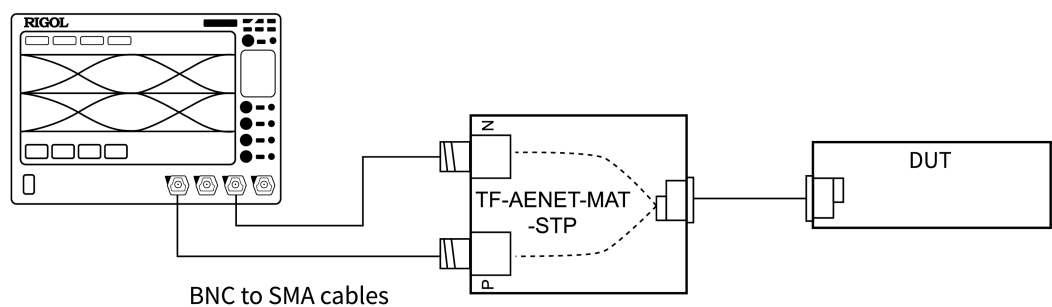

Figure 7.2 Test Connection Diagram for the Two Single Signals

- Connect the DUT to the MDI interface of the fixture adaptor board by using the network cable.
- Connect Port P and Port N of TF-AENET-MAT-STP to the analog channel CH1 and CH3 of the oscilloscope by using the BNC-to-SMA cable.



TIP

When you select "Two Single Signals" as the signal type, CH1 and CH3 are recommended for "Dp Source" and "Dn Source" respectively; also you can select CH2 and CH4. However, CH2 and CH3 are not recommended, as this will affect the sample rate, eventually affecting the measurement results.

Test Procedures

1. Set the DUT as the master and set it to generate a Test Mode 1 signal.
2. Configure the DS70000 oscilloscope. Click or tap the function navigation icon and then select "AETH" to enter the "Automotive Ethernet Test" menu. In the **System Settings** tab, select the desired signal type. Then in the **Configuration** tab, select the specified channel source of the signal according to the actual device connection.
3. Click or tap **View Wfm** to preview the waveform for the specified test item in the waveform view to ensure that the waveform is properly output.
4. Click or tap **Test** to start testing. The "Compliance Analysis" dialog box is displayed. Wait for its analysis result.
5. After finishing the analysis, you can view the test results in the "100Base-T1 Results" window.

7.2 100Base-T1 MDI Output Jitter

For 100Base-T1 Test Mode 2 MDI Output Jitter, use the test fixture TF-AENET-MAT-STP (adaptor board) and the test fixture TF-AENET-MB-STP Section3 (breakout board) to perform the test. This section introduces the test by taking RIGOL DS70000 series oscilloscope as an example.

Select the Signal Type and Test Item

1. In the DS70000 operation interface, click or tap  > **AETH** to enter the "Automotive Ethernet Test" menu.

2. Click or tap **System Settings** to enter system setting menu.
 - Click or tap to select **IEEE** as the specification, and **100Mbps** as the signal rate.
 - Click or tap to select **Single Differential Signal** for the signal type.
3. Click or tap **Test Item** > **100Base-T1 Tests** > **Test Mode 2** > **MDI Output Jitter(Master)** to select the MDI Output Jitter test.

Connect the Device

Refer to *Figure 7.1* to connect the oscilloscope, the fixture, and the DUT.

Test Procedures

1. Set the DUT as the master and set it to generate a Test Mode 2 signal.
2. Configure the DS70000 oscilloscope. Click or tap the function navigation icon and then select "AETH" to enter the "Automotive Ethernet Test" menu. In the **System Settings** tab, select the desired signal type. Then in the **Configuration** tab, select the specified channel source of the signal according to the actual device connection.
3. Click or tap **View Wfm** to preview the waveform for the specified test item in the waveform view to ensure that the waveform is properly output.
4. Click or tap **Test** to start testing. The "Compliance Analysis" dialog box is displayed. Wait for its analysis result.
5. After finishing the analysis, you can view the test results in the "100Base-T1 Results" window.

7.3 100Base-T1 Transmit Clock Frequency

For 100Base-T1 Test Mode 2 Transmit Clock Frequency, use the test fixture TF-AENET-MAT-STP (adaptor board) and the test fixture TF-AENET-MB-STP Section3 (breakout board) to perform the test. This section introduces the test by taking RIGOL DS70000 series oscilloscope as an example.

Select the Signal Type and Test Item

1. In the DS70000 operation interface, click or tap  > **AETH** to enter the "Automotive Ethernet Test" menu.
2. Click or tap **System Settings** to enter system setting menu.

- Click or tap to select **IEEE** as the specification, and **100Mbps** as the signal rate.
- Click or tap to select **Two Single Signals** or **Single Differential Signal** for the signal type.

3. Click or tap **Test Item** > **100Base-T1 Tests** > **Test Mode 2** > **Transmit Clock Frequency** to select the Transmit Clock Frequency test.

Connect the Device

For different signal types, the test connection diagrams are different. For the connection diagram, refer to *Connect the Device*.

Test Procedures

Refer to *Test Procedures* to complete the test.

7.4 100Base-T1 Slave TX_TCLK Jitter (Without the Clock)

For 100Base-T1 Test Mode 3 Slave TX_TCLK Jitter (Without the Clock), use the test fixture TF-AENET-MAT-STP (adaptor board) and the test fixture TF-AENET-MB-STP Section3 (breakout board) to perform the test. This section introduces the test by taking RIGOL DS70000 series oscilloscope as an example.

If the DUT does not support the TX_TCLK clock signal, then measure the MDI signal jitter when the DUT is in slave mode.

Select the Signal Type and Test Item

1. In the DS70000 operation interface, click or tap  > **AETH** to enter the "Automotive Ethernet Test" menu.
2. Click or tap **System Settings** to enter system setting menu.
 - Click or tap to select **IEEE** as the specification, and **100Mbps** as the signal rate.
 - Click or tap to select **Single Differential Signal** for the signal type.
 - Uncheck the checkbox of "Use TX_TCLK(Test Mode 3)".
3. Click or tap **Test Item** > **100Base-T1 Tests** > **Test Mode 3** > **Slave TX_TCLK Jitter** to select the Slave TX_TCLK Jitter test.

Connect the Device

Refer to *Figure 7.1* to connect the oscilloscope, the fixture, and the DUT.

Test Procedures

1. Set the DUT as the slave and set it to generate a Test Mode 3 signal.
2. Configure the DS70000 oscilloscope. Click or tap the function navigation icon and then select "AETH" to enter the "Automotive Ethernet Test" menu. In the **System Settings** tab, select the desired signal type. Then in the **Configuration** tab, select the specified channel source of the signal according to the actual device connection.
3. Click or tap **View Wfm** to preview the waveform for the specified test item in the waveform view to ensure that the waveform is properly output.
4. Click or tap **Test** to start testing. The "Compliance Analysis" dialog box is displayed. Wait for its analysis result.
5. After finishing the analysis, you can view the test results in the "100Base-T1 Results" window.

7.5 100Base-T1 Slave TX_TCLK Jitter (With the Clock)

For 100Base-T1 Test Mode 3 Slave TX_TCLK Jitter (With the Clock), the fixture is not required for this test. This section introduces the test by taking RIGOL DS70000 series oscilloscope as an example.

If the DUT can directly output the TX_TCLK clock signal, then measure the TX_TCLK clock signal jitter when the DUT is in slave mode.

Select the Signal Type and Test Item

1. In the DS70000 operation interface, click or tap  > **AETH** to enter the "Automotive Ethernet Test" menu.
2. Click or tap **System Settings** to enter system setting menu.
 - Click or tap to select **IEEE** as the specification, and **100Mbps** as the signal rate.
 - Configuration Click or tap to select **Single Differential Signal** for the signal type.
 - Check the checkbox of "Use TX_TCLK(Test Mode 3)".
3. Click or tap **Test Item** > **100Base-T1 Tests** > **Test Mode 3** > **Slave TX_TCLK Jitter** to select the Slave TX_TCLK Jitter test.

Connect the Device

Test Connection Diagram

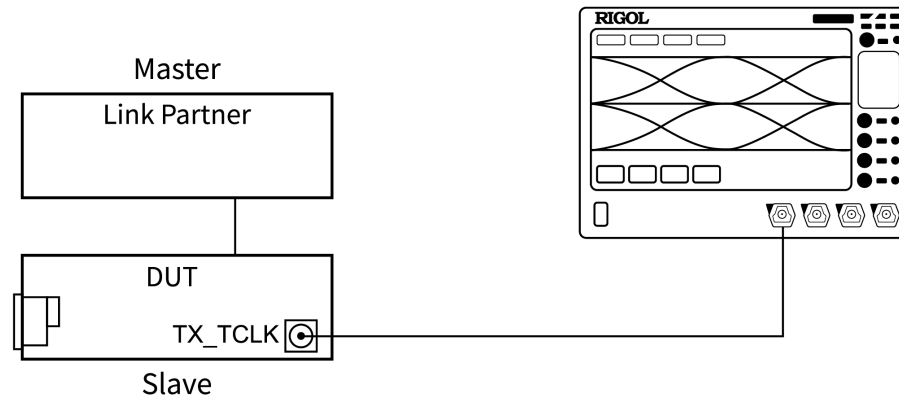

Figure 7.3 Test Connection Diagram

- Connect the DUT with the Link Partner. Set the DUT to Slave and the Link Partner to Master.
- Connect the clock interface (TX_TCLK) of the slave DUT to the analog channel of the oscilloscope by using the BNC-to-SMA cable.

Test Procedures

1. Set the DUT as the slave and set it to generate a Test Mode 3 signal.
2. Configure the DS70000 oscilloscope. Click or tap the function navigation icon and then select "AETH" to enter the "Automotive Ethernet Test" menu. In the "System Settings" tab, select the desired signal type. Then in the **Configuration** tab, select the specified channel source of the signal according to the actual device connection.
3. Click or tap **View Wfm** to preview the waveform for the specified test item in the waveform view to ensure that the waveform is properly output.
4. Click or tap **Test** to start testing. The "Compliance Analysis" dialog box is displayed. Wait for its analysis result.
5. After finishing the analysis, you can view the test results in the "100Base-T1 Results" window.

7.6 100Base-T1 Transmitter Distortion (With Disturbing Signal, With Reference Clock)

For 100Base-T1 Test Mode 4 Transmitter Distortion (With Disturbing Signal, With Reference Clock), use the test fixture TF-AENET-MAT-STP (adaptor board) and the test fixture TF-AENET-MB-STP Section2 (breakout board), and the test fixture TF-AENET-PAB-STP (preamplifier board) to perform the test in a scenario with the disturbing signal and with the reference clock. This section introduces the test by taking RIGOL DS70000 series oscilloscope as an example.

Select the Signal Type and Test Item

1. In the DS70000 operation interface, click or tap  > **AETH** to enter the "Automotive Ethernet Test" menu.
2. Click or tap **System Settings** to enter system setting menu.
 - Click or tap to select **IEEE** as the specification, and **100Mbps** as the signal rate.
 - Click or tap to select **Two Single Signals** for the signal type.
 - In the **System Settings** tab, check the checkbox of "Use Disturbing Signal" and check the checkbox of "Use 10 MHz Ref Clock For Synchronization".
3. Click or tap **Test Item** > **100Base-T1 Tests** > **Test Mode 4** > **Transmitter Distortion** to select the Transmitter Distortion test.

7.6.1 To Calibrate the Disturbing Signal

For the test scenarios with the disturbing signal, perform calibration on the disturbing signal.

Device Connection Diagram

Use TF-AENET-MB-STP Section2 (breakout board) and TF-AENET-PAB-STP (preamplifier board) to calibrate the disturbing signal according to the following connection diagram.

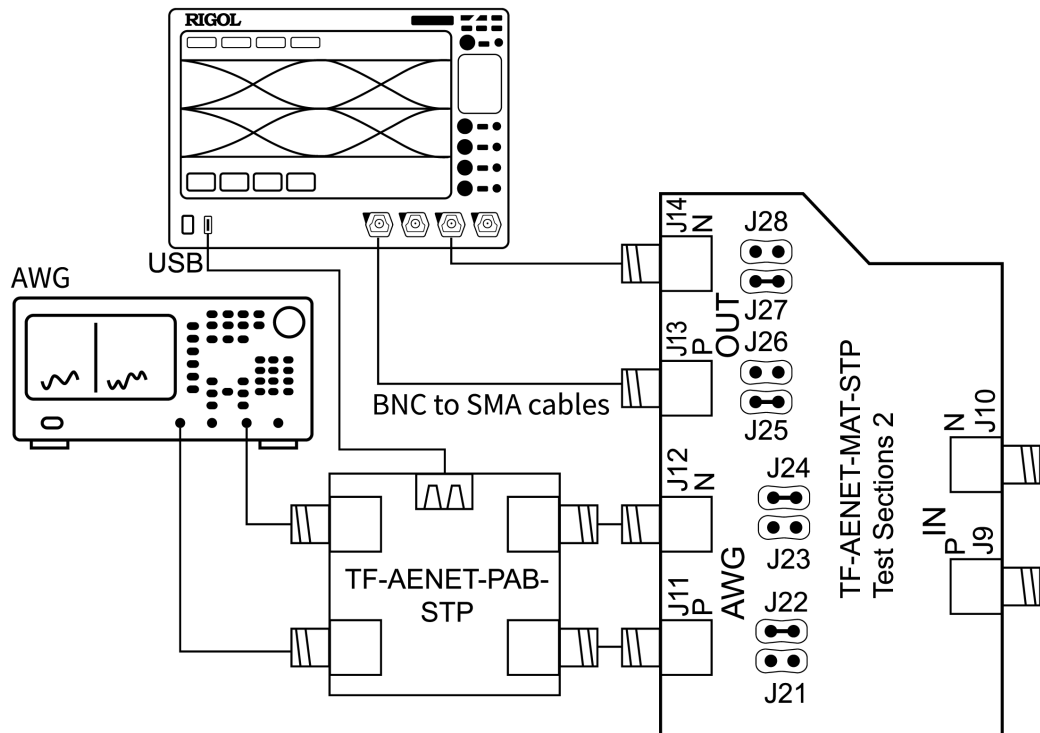

Figure 7.4 Connection Diagram of Calibration for Disturbing Signals

- Connect the two output terminals of the Function/Arbitrary Waveform Generator (AWG) to SMA interface of TF-AENET-PAB-STP by using the BNC-to-SMA cable.
- Connect Port J11 and Port J12 of the Fixture TF-AENET-MB-STP Section2 to the SMA interface of the Fixture TF-AENET-PAB-STP by using the adaptor.
- Connect Port J13 and Port J14 of Fixture TF-AENET-MB-STP Section2 to the analog channel of the oscilloscope by using the BNC-to-SMA cable.
- Short the jumper J27, J25, J24, and J22.

Calibration Operation Procedures

1. Set the Function/Arbitrary Waveform Generator to generate a disturbing Sine signal whose frequency is 11.111 MHz, amplitude is $2.7 V_{pp}$.
2. In the "Configuration" menu of DS70000 Automotive Ethernet Test, click or tap the drop-down button of **Dp Source** to select CH1. Click or tap the drop-down button of **Dn Source** to select CH3. Ensure that the selected channels are consistent with those you select for the device in the connection diagram.

3. In the "System Settings" menu, click or tap **Calibrate** to enter the fixture calibration menu, as shown in *Figure 7.5*.
4. Click or tap **Measure** in the Disturbing Signal section to measure the disturbing signal generated from the waveform generator. Then the measured value will be displayed.
5. Compare the measured value with the expected value. If the measured value is not close to the expected value, please modify the amplitude and clock frequency of the Function/Arbitrary Waveform Generator. Restart to measure it and compare the values again to make their values approximately equal to each other.

The screenshot shows the 'DUT Calibration' interface with a close button (X) in the top right corner. It is divided into two main sections: 'Disturbing Signal' and 'Fixture Calibration'.

Disturbing Signal Section:

	Expected Value	Measured Value	
Frequency	125MHz		Measure
Level	1.8V		Default

Fixture Calibration Section:

	Expected Value	Measured Value	
Pre-attenuation	2.22V		Measure
Post-attenuation	1.8V		Measure
Attenuation	1.5		Default

At the bottom of the screen, there are three buttons: '< Back', 'Apply', and '> Connection Diagram'.

Figure 7.5 Fixture Calibration

7.6.2 Fixture Calibration

Before performing the compliance test, first calibrate the fixture.

Device Connection Diagram

Calibrate the Fixture TF-AENET-MB-STP Section3. Connect the devices according to the following figure.

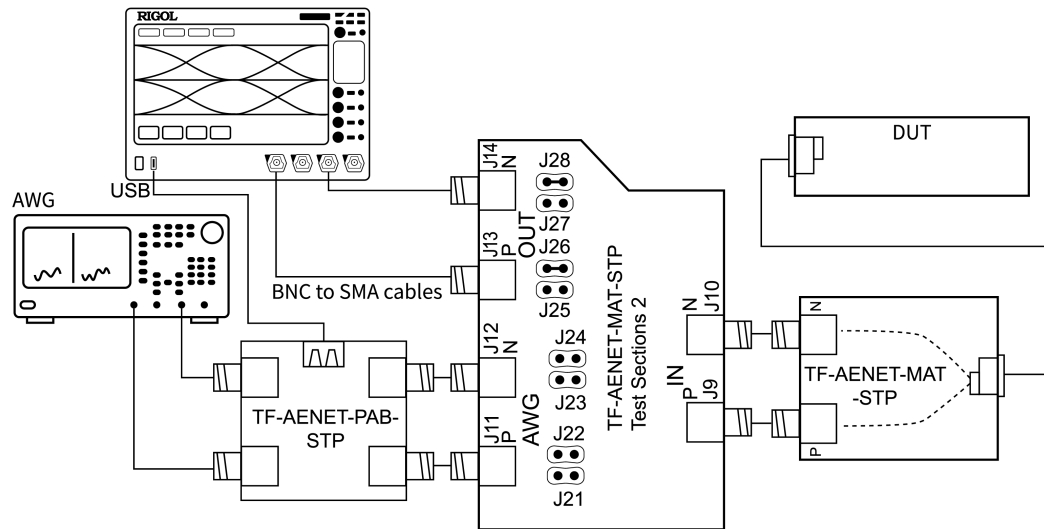

Figure 7.6 TC2 Calibration Connection Diagram

- Connect the two output terminals of the Function/Arbitrary Waveform Generator (AWG) to SMA interface of TF-AENET-PAB-STP by using the BNC-to-SMA cable.
- Connect Port J11 and Port J12 of the Fixture TF-AENET-MB-STP Section2 to the SMA interface of the Fixture TF-AENET-PAB-STP by using the adaptor.
- Connect Port J13 and Port J14 of Fixture TF-AENET-MB-STP Section2 to the analog channel of the oscilloscope by using the BNC-to-SMA cable.
- Connect Port J9 and Port J10 of the Fixture TF-AENET-MB-STP Section2 to the SMA interface of the Fixture TF-AENET-MAT-STP by using the adaptor.
- Connect the DUT to the MDI interface of the Fixture TF-AENET-MAT-STP (adaptor board) by using the network cable.
- Short the jumper J28 and J26 of TF-AENET-MB-STP Section2.

Calibration Operation Procedures

1. Set the DUT to generate a Test Mode 4 signal.
2. In the "Configuration" menu of DS70000 Automotive Ethernet Test, click or tap the drop-down button of **Dp Source** to select CH1. Click or tap the drop-down button of **Dn Source** to select CH3. Ensure that the selected channels are consistent with those you select for the device in the connection diagram.

3. In the "System Settings" menu, click or tap **Calibrate** to enter the fixture calibration menu, as shown in *Figure 7.5*.
4. Click or tap **Measure** at the right part of the Pre-attenuation in the DUT Calibration interface to obtain the pre-attenuation measured value.
5. Click or tap **Measure** at the right part of the Post-attenuation in the DUT Calibration interface to obtain the post-attenuation measured value.
6. After finishing the measurement, click or tap **Apply** to complete the fixture calibration. Click or tap **Back** to go back to the "System Settings" menu.

7.6.3 Distortion Test

After calibrating the disturbing signal and the fixture, perform the transmitter distortion test in a scenario with the disturbing signal. Connect the test devices according to the following connection diagram.

Connect the Device

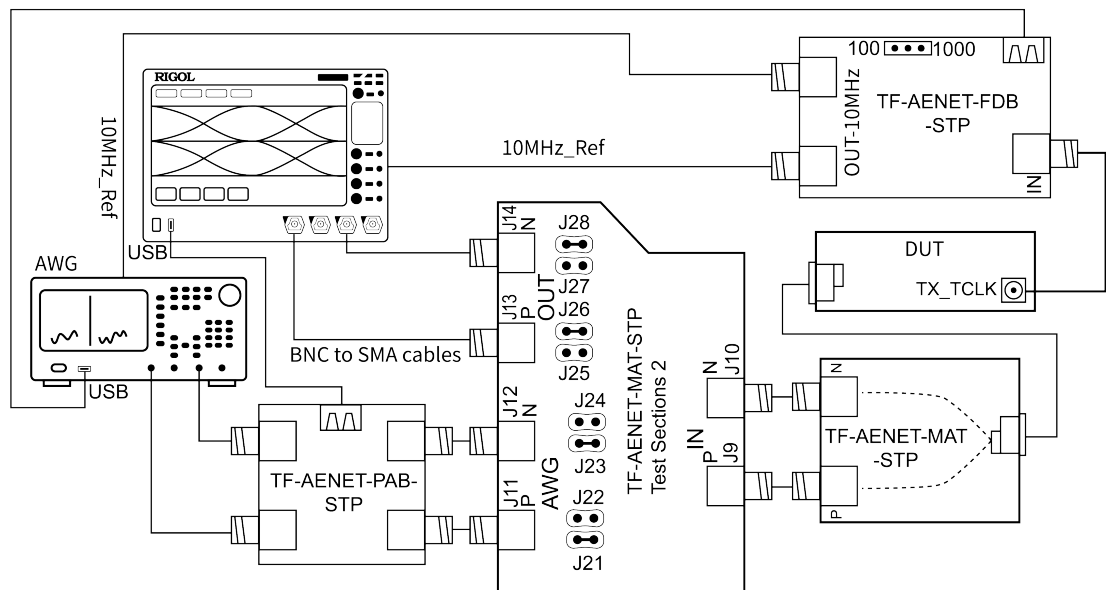

Figure 7.7 Connection Diagram

- Connect the two output terminals of the Function/Arbitrary Waveform Generator (AWG) to the SMA interface of TF-AENET-PAB-STP by using the BNC-to-SMA cable.

- Connect Port J11 and Port J12 of the Fixture TF-AENET-MB-STP Section2 to the SMA interface of the Fixture TF-AENET-PAB-STP by using the adaptor.
- Connect Port J13 and Port J14 of Fixture TF-AENET-MB-STP Section2 to the analog channel of the oscilloscope by using the BNC-to-SMA cable.
- Connect Port J9 and Port J10 of the Fixture TF-AENET-MB-STP Section2 to the SMA interface of the Fixture TF-AENET-MAT-STP by using the adaptor.
- Connect the DUT to the MDI interface of the Fixture TF-AENET-MAT-STP (adaptor board) by using the network cable.
- Connect the IN interface of the Fixture TF-AENET-FDB-STP and the clock interface TX_TCLK of the DUT. Connect one OUT interface of the Fixture TF-AENET-FDB-STP to the reference clock input interface of the oscilloscope, and the other OUT interface of the Fixture TF-AENET-FDB-STP to the reference clock input interface of the Function/Arbitrary Waveform Generator (AWG). Then use the jumper cap to select 100 MHz.
- Short the jumper J28 and J26 of TF-AENET-MB-STP Section2.

Test Procedures

1. Set the DUT as the master and set it to generate a Test Mode 4 signal.
2. Configure the DS70000 oscilloscope.
 - a. After selecting a test item, click or tap the **Configuration** tab to enter the Configuration menu.
 - b. Select the signal type to "Single Two Signals". In the "Configuration" menu, click or tap the drop-down button of **Dp Source** to select CH1. Click or tap the drop-down button of **Dn Source** to select CH3. Ensure that the selected channels are consistent with those you select for the device in the connection diagram.
3. Click or tap **View Wfm** to preview the waveform for the specified test item in the waveform view to ensure that the waveform is properly output.
4. Click or tap **Test** to start testing. The "Compliance Analysis" dialog box is displayed. Wait for its analysis result.

5. After finishing the analysis, you can view the test results in the "100Base-T1 Results" window.

7.7 100Base-T1 Transmitter Distortion (With Disturbing Signal, Without Reference Clock)

For 100Base-T1 Test Mode 4 Transmitter Distortion (With Disturbing Signal, Without Reference Clock), use the test fixture TF-AENET-MAT-STP (adaptor board), the test fixture TF-AENET-MB-STP Section2 (breakout board), and the test fixture TF-AENET-PAB-STP (preamplifier board) to perform the test in a scenario with the disturbing signal and without the reference clock. This section introduces the test by taking RIGOL DS70000 series oscilloscope as an example.

Select the Signal Type and Test Item

1. In the DS70000 operation interface, click or tap  > **AETH** to enter the "Automotive Ethernet Test" menu.
2. Click or tap **System Settings** to enter system setting menu.
 - Click or tap to select **IEEE** as the specification, and **100Mbps** as the signal rate.
 - Click or tap to select **Two Single Signals** for the signal type.
 - In the System Settings tab, check the checkbox of "Use Disturbing Signal" and uncheck the checkbox of "Use 10 MHz Ref Clock For Synchronization".
3. Click or tap **Test Item** > **100Base-T1 Tests** > **Test Mode 4** > **Transmitter Distortion** to select the transmitter distortion test.

Calibrate the Disturbing Signal and the Fixture

Refer to *To Calibrate the Disturbing Signal* to calibrate the disturbing signal.

Refer to *Fixture Calibration* to calibrate the fixture.

Connect the Device

Connect the test devices according to the following connection diagram.

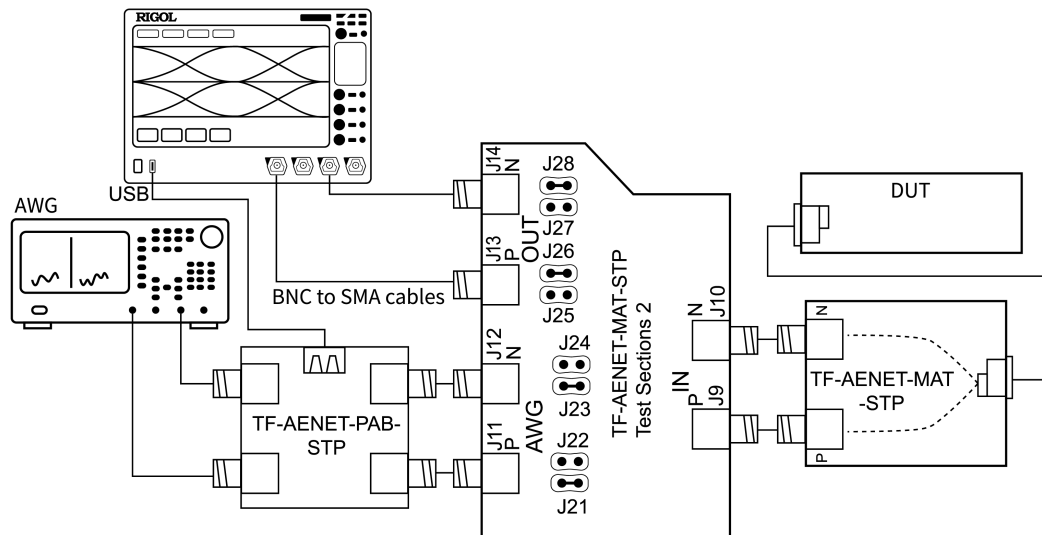

Figure 7.8 Connection Diagram

- Connect the two output terminals of the Function/Arbitrary Waveform Generator (AWG) to SMA interface of TF-AENET-PAB-STP by using the BNC-to-SMA cable.
- Connect Port J11 and Port J12 of the Fixture TF-AENET-MB-STP Section2 to the SMA interface of the Fixture TF-AENET-PAB-STP by using the adaptor.
- Connect Port J13 and Port J14 of Fixture TF-AENET-MB-STP Section2 to the analog channel of the oscilloscope by using the BNC-to-SMA cable.
- Connect Port J9 and Port J10 of the Fixture TF-AENET-MB-STP Section2 to the SMA interface of the Fixture TF-AENET-MAT-STP by using the adaptor.
- Connect the DUT to the MDI interface of the Fixture TF-AENET-MAT-STP (adaptor board) by using the network cable.
- Short the jumper J28, J26, J23 and J21 of TF-AENET-MB-STP Section2.

Test Procedures

1. Set the DUT as the master and set it to generate a Test Mode 4 signal.
2. Configure the DS70000 oscilloscope.
 - a. After selecting a test item, click or tap the **Configuration** tab to enter the Configuration menu.

- b. In the "Configuration" menu, click or tap the drop-down button of **Dp Source** to select CH1. Click or tap the drop-down button of **Dn Source** to select CH3. Ensure that the selected channels are consistent with those you select for the device in the connection diagram.
3. Click or tap **View Wfm** to preview the waveform for the specified test item in the waveform view to ensure that the waveform is properly output.
4. Click or tap **Test** to start testing. The "Compliance Analysis" dialog box is displayed. Wait for its analysis result.
5. After finishing the analysis, you can view the test results in the "100Base-T1 Results" window.

7.8 100Base-T1 Transmitter Distortion (Without Disturbing Signal, With Reference Clock)

For 100Base-T1 Test Mode 4 Transmitter Distortion (Without Disturbing Signal, With Reference Clock), use the test fixture TF-AENET-MAT-STP (adaptor board) and the test fixture TF-AENET-FDB-STP (frequency divider board) to perform the test in a scenario without the disturbing signal and with the reference clock. This section introduces the test by taking RIGOL DS70000 series oscilloscope as an example.

Select the Signal Type and Test Item

1. In the DS70000 operation interface, click or tap  > **AETH** to enter the "Automotive Ethernet Test" menu.
2. Click or tap **System Settings** to enter system setting menu.
 - Click or tap to select **IEEE** as the specification, and **100Mbps** as the signal rate.
 - Click or tap to select **Two Single Signals** for the signal type.
 - In the **System Settings** tab, uncheck the checkbox of "Use Disturbing Signal" and check the checkbox of "Use 10 MHz Ref Clock For Synchronization".
3. Click or tap **Test Item** > **100Base-T1 Tests** > **Test Mode 4** > **Transmitter Distortion** to select the Transmitter Distortion test.

Connect the Device

Connect the test devices according to the following connection diagram.

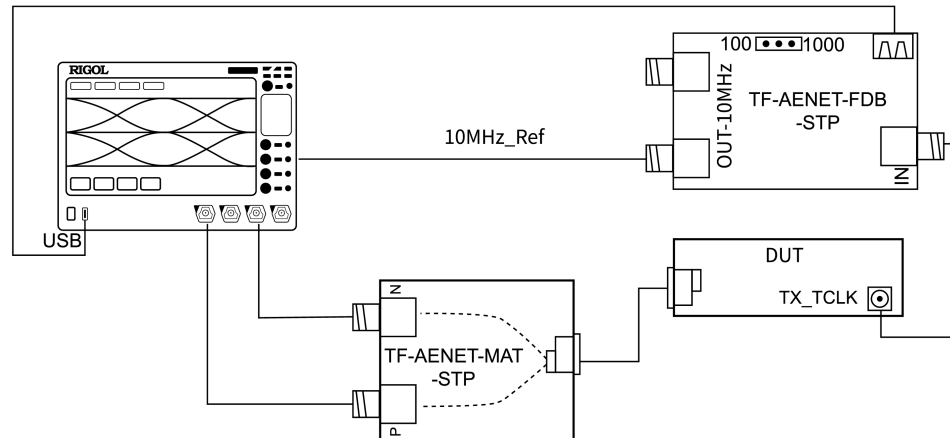

Figure 7.9 Connection Diagram

- Connect the DUT to the MDI interface of the fixture adaptor board by using the network cable.
- Connect Port P and Port N of the fixture adaptor to the analog channel of the oscilloscope by using the BNC-to-SMA cable.
- Connect the IN interface of the Fixture TF-AENET-FDB-STP and the clock interface TX_TCLK of the DUT. Connect the OUT interface of the Fixture TF-AENET-FDB-STP and the reference clock input interface of the oscilloscope. Then use the jumper cap to select 100 MHz.

Test Procedures

1. Set the DUT as the master and set it to generate a Test Mode 4 signal.
2. Configure the DS70000 oscilloscope.
 - a. After selecting a test item, click or tap the **Configuration** tab to enter the Configuration menu.
 - b. In the "Configuration" menu, click or tap the drop-down button of **Dp Source** to select CH1. Click or tap the drop-down button of **Dn Source** to select CH3. Ensure that the selected channels are consistent with those you select for the device in the connection diagram.

3. Click or tap **View Wfm** to preview the waveform for the specified test item in the waveform view to ensure that the waveform is properly output.
4. Click or tap **Test** to start testing. The "Compliance Analysis" dialog box is displayed. Wait for its analysis result.
5. After finishing the analysis, you can view the test results in the "100Base-T1 Results" window.

7.9 100Base-T1 Transmitter Distortion (Without Disturbing Signal, Without Reference Clock)

For 100Base-T1 Test Mode 4 Transmitter Distortion (Without Disturbing Signal, Without Reference Clock), use the test fixture TF-AENET-MAT-STP (adaptor board) to perform the test in a scenario without the disturbing signal and without the reference clock. This section introduces the test by taking RIGOL DS70000 series oscilloscope as an example.

Select the Signal Type and Test Item

1. In the DS70000 operation interface, click or tap  > **AETH** to enter the "Automotive Ethernet Test" menu.
2. Click or tap **System Settings** to enter system setting menu.
 - Click or tap to select **IEEE** as the specification, and **100Mbps** as the signal rate.
 - Click or tap to select **Two Single Signals** for the signal type.
 - In the **System Settings** tab, uncheck the checkbox of "Use Disturbing Signal" and uncheck the checkbox of "Use 10 MHz Ref Clock For Synchronization".
3. Click or tap **Test Item** > **100Base-T1 Tests** > **Test Mode 4** > **Transmitter Distortion** to select the Transmitter Distortion test.

Connect the Device

Refer to [Figure 7.2](#) to connect the oscilloscope, the fixture, and the DUT.

Test Procedures

1. Set the DUT as the master and set it to generate a Test Mode 4 signal.
2. In the "Configuration" menu of DS70000 Automotive Ethernet Test, click or tap the drop-down button of **Dp Source** to select CH1. Click or tap the drop-down button

- of **Dn Source** to select CH3. Ensure that the selected channels are consistent with those you select for the device in the connection diagram.
3. Click or tap **View Wfm** to preview the waveform for the specified test item in the waveform view to ensure that the waveform is properly output.
 4. Click or tap **Test** to start testing. The "Compliance Analysis" dialog box is displayed. Wait for its analysis result.
 5. After finishing the analysis, you can view the test results in the "100Base-T1 Results" window.

7.10 100Base-T1 Power Spectral Density

For 100Base-T1 Test Mode 5 Power Spectral Density, use the test fixture TF-AENET-MAT-STP (adaptor board) and the test fixture TF-AENET-MB-STP Section3 (breakout board) to perform the test. This section introduces the test by taking RIGOL DS70000 series oscilloscope as an example.

Select the Signal Type and Test Item

1. In the DS70000 operation interface, click or tap  > **AETH** to enter the "Automotive Ethernet Test" menu.
2. Click or tap **System Settings** to enter system setting menu.
 - Click or tap to select **IEEE** as the specification, and **100Mbps** as the signal rate.
 - Click or tap to select **Single Differential Signal** for the signal type.
3. Click or tap **Test Item** > **100Base-T1 Tests** > **Test Mode 5** > **Power Spectral Density** to select the Power Spectral Density test.

Connect the Device

Refer to *Figure 7.1* to connect the oscilloscope, the fixture, and the DUT.

Test Procedures

1. Set the DUT as the master and set it to generate a Test Mode 5 signal.
2. Configure the DS70000 oscilloscope. Click or tap the function navigation icon and then select "AETH" to enter the "Automotive Ethernet Test" menu. In the "System Settings" tab, select the signal type according to the actual device connection.

3. Click or tap **View Wfm** to preview the waveform for the specified test item in the waveform view to ensure that the waveform is properly output.
4. Click or tap **Test** to start testing. The "Compliance Analysis" dialog box is displayed. Wait for its analysis result.
5. After finishing the analysis, you can view the test results in the "100Base-T1 Results" window.

7.11 100Base-T1 Peak Differential Output

For 100Base-T1 Test Mode 5 Peak Differential Output, use the test fixture TF-AENET-MAT-STP (adaptor board) and the test fixture TF-AENET-MB-STP Section3 (breakout board) to perform the test. This section introduces the test by taking RIGOL DS70000 series oscilloscope as an example.

Select the Signal Type and Test Item

1. In the DS70000 operation interface, click or tap  > **AETH** to enter the "Automotive Ethernet Test" menu.
2. Click or tap **System Settings** to enter system setting menu.
 - Click or tap to select **IEEE** as the specification, and **100Mbps** as the signal rate.
 - Click or tap to select **Two Single Signals** or **Single Differential Signal** for the signal type.
3. Click or tap **Test Item** > **100Base-T1 Tests** > **Test Mode 5** > **Peak Differential Output** to select the Peak Differential Output test.

Connect the Device

For different signal types, the test connection diagrams are different. For the connection diagram, refer to *Connect the Device*.

Test Procedures

Refer to *Test Procedures* to complete the test.

7.12 100Base-T1 MDI Return Loss

RIGOL DS70000 series oscilloscope supports multiple test schemes of return loss test. You can select a different test scheme according to your current test devices.

- **Vector Network Analyzer (VNA)**

Use a VNA device to perform the loss test. Then export the measurement data generated from the VNA device to the oscilloscope to perform the compliance analysis. Generate the analysis report.

- **Real-time spectrum analyzer with VNA mode**

RIGOL's RSA3000N series spectrum analyzer is recommended.

- **Online configuration:** Build network connection between the oscilloscope and the spectrum analyzer. Then control the spectrum analyzer to complete the calibration and measurement operation through the oscilloscope. After finishing the measurement, the oscilloscope reads the measurement data, makes an analysis, and generates the analysis report.
- **Offline import:** Use the VNA mode of the RSA3000N series spectrum analyzer to perform the loss test. Import the measurement data generated from the spectrum analyzer to the oscilloscope offline to perform the compliance analysis. Then generate the analysis report.

The fixtures for the return loss test include: TF-AENET-MSB-STP (matrix switching) and TF-AENET-MAT-STP (adaptor board).

7.12.1 Offline Import

If you select offline import, use the VNA device or the VNA mode equipped in RIGOL's RSA3000N series spectrum analyzer to perform the test. The procedures are the same.

This section introduces the test by taking RIGOL DS70000 and RSA3000N series as an example.

1. First use RSA3000N to test the DUT, and export the measurement data of S-parameters. The formats of the measurement data are "*.s1p" (S11 test), "*.s2p" (S21 test), and etc. For details, refer to *VNA User Guide*.
2. Save the exported measurement data file to the internal or external memory of the oscilloscope. For detailed procedures, refer to *DS70000 User Guide*.
3. In the DS70000 operation interface, click or tap  > **AETH** to enter the "Automotive Ethernet Test" menu.

- Click or tap **System Settings** to enter system setting menu. Click or tap to select **IEEE** as the specification, and **100Mbps** as the signal rate.
- In the loss test item, click or tap to select "RSA". Click or tap **Offline Import**, then the "Offline Import" interface is displayed, as shown in the figure below.

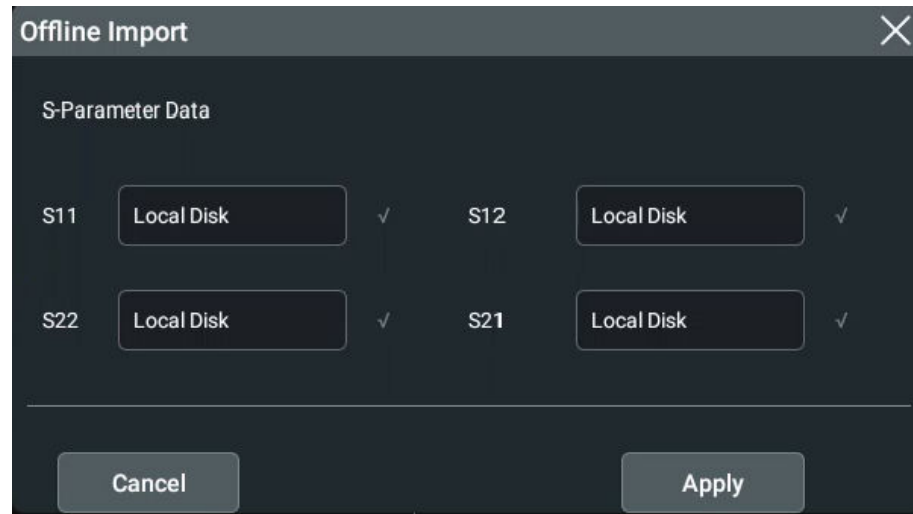



Figure 7.10 Offline Import Interface

- Click or tap the input field of **S11**, **S12**, **S22**, and **S21** respectively, then the "Disk Management" interface is displayed. Select the desired data file from the specified path. Then the file is imported. If successfully imported, the tick icon (✓) following the input field of **S11**, **S12**, **S22**, or **S21** turns out to be green. After importing all the S-parameter data, click or tap **Apply** to apply the data import. Then the measurement analysis report is generated.

7.12.2 Online Configuration

Use RIGOL's RSA3000N series spectrum analyzer to perform the return loss test with the online configuration. This section introduces the test by taking RIGOL DS70000 and RSA3000N series as an example.

7.12.2.1 To Select the Signal Type and Test Item

- In the DS70000 operation interface, click or tap  > **AETH** to enter the "Automotive Ethernet Test" menu.
- Click or tap **System Settings** to enter system setting menu.

- Click or tap to select **IEEE** as the specification, and **100Mbps** as the signal rate.
 - Click or tap to select **Two Single Signals** for the signal type.
3. Click or tap **Test Item** > **100Base-T1 Test** > **MDI Return Loss** to select the MDI Return Loss test.

7.12.2.2 S-Parameter Calibration

Connect the RSA Device

In the "System Settings" tab, select "RSA" under **Device Select**. Then click or tap the input field of **IP Address**, then the interface is displayed, prompting you to input the IP address of the specified RSA device with the pop-up numeric keypad. If successfully connected, Connection Status shows "Connected".

Get the Operation Procedure

In the "System Settings" menu, click or tap **Calibrate**, then the "S-Parameter Test" interface is displayed, as shown in the figure below.

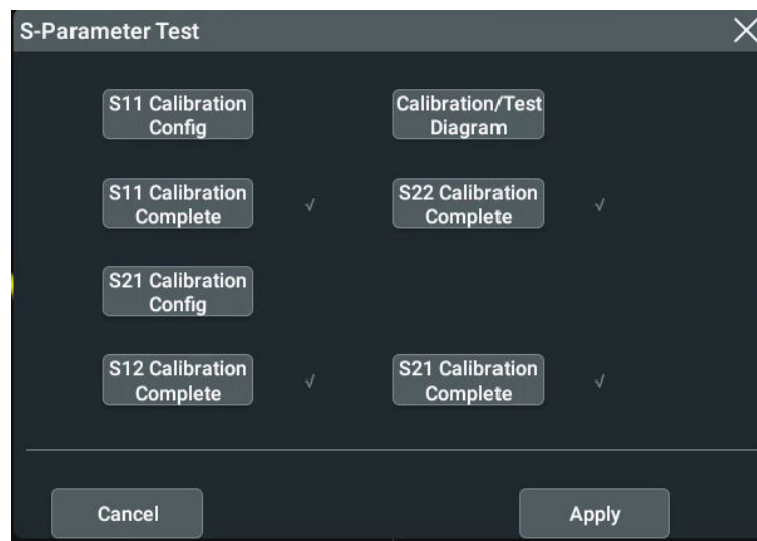

Figure 7.11 S-Parameter Test

Click or tap **Calibration/Test Diagram**, then the "Calibration/Test Diagram" interface is displayed, showing the calibration connection diagram and the calibration operation procedures.

S11 Calibration

S11 indicates the input reflection coefficient, that is, input return loss.

Connect the device according to the connection diagram shown below. Connect Port J1 and Port J2 of the fixture TF-AENET-MSB-STP (matrix switching) to the RF input

terminal and tracking generator (TG) output terminal of the RSA3000N spectrum analyzer respectively via the SMA adaptor. Connect Port J3 to the VNA calibration kit (Open, Short, and Load)

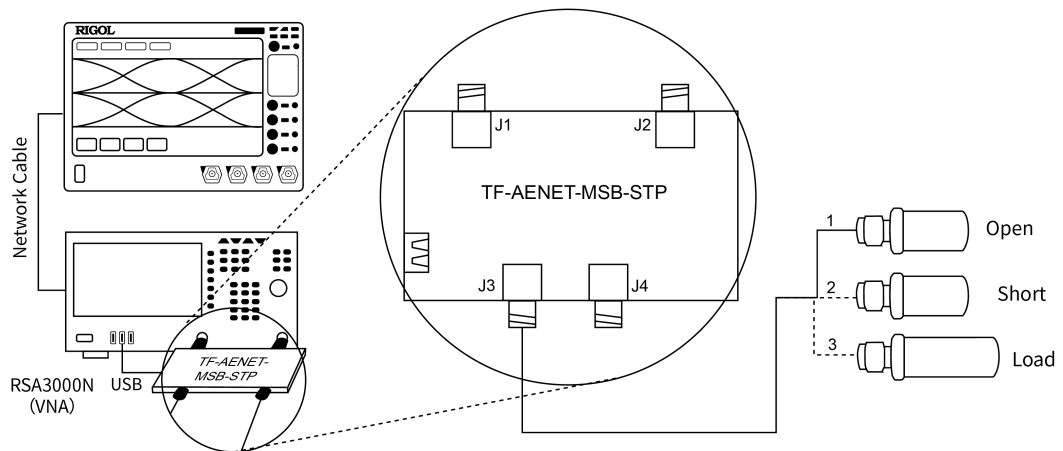

Figure 7.12 S11 Calibration Connection Diagram

- In the "S-Parameter Test" interface, click or tap **S11 Calibration Config**, then the S11/S22 calibration configuration is performed automatically on RSA3000N.
- Set the dip switch on the fixture TF-AENET-MSB-STP to a downward position, then perform Open, Short, and Load calibration manually on RSA3000N in sequence.
- Click or tap **S11 Calibration Complete**, and the calibration data are saved. After the calibration is completed, the tick icon ✓ following the specified calibration turns green.
- Set the dip switch on the fixture TF-AENET-MSB-STP to an upward position, then perform Open, Short, and Load calibration manually on RSA3000N in sequence.
- Click or tap **S22 Calibration Complete** to complete the S22 calibration, and the calibration data are saved. After the calibration is completed, the tick icon ✓ following the specified calibration turns green.

S21 Calibration

S21 provides the transmission coefficient measurement. It measures the forward (Port 1 to Port 2) transmission coefficient. It displays the gain or loss of the DUT. Connect the Through calibration kit to the two ports to measure the calibration coefficient, which can efficiently eliminate the transmission tracking error resulting from the transmission test device by using these ports.

Connect the device according to the connection diagram shown below. Connect Port J1 and Port J2 of the fixture TF-AENET-MSB-STP (matrix switching) to the RF input terminal and tracking generator (TG) output terminal of the RSA3000N spectrum analyzer respectively via the SMA adaptor. Connect J3 and J4 by using the Through calibration kit.

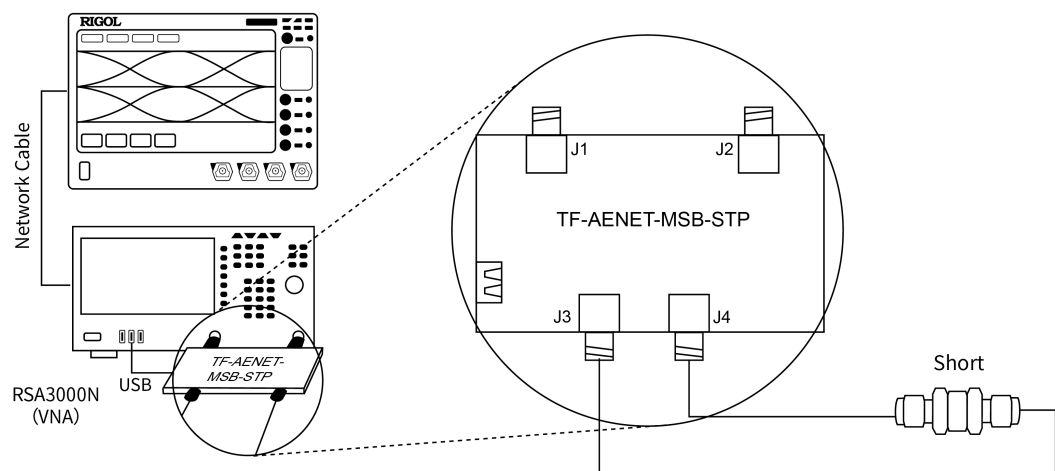

Figure 7.13 S21 Calibration Connection Diagram

- In the "S-Parameter Test" interface, click or tap **S21 Calibration Config**, then the S21/S12 calibration configuration is performed automatically on RSA3000N.
- Set the dip switch on the fixture TF-AENET-MSB-STP to a downward position, then perform the Through calibration on RSA3000N manually.
- Click or tap **S12 Calibration Complete** to complete the S12 calibration, and the calibration data are saved. After the calibration is completed, the tick icon ✓ following the specified calibration turns green.
- Set the dip switch on the fixture TF-AENET-MSB-STP to an upward position, then perform the Through calibration manually on RSA3000N.

- Click or tap **S21 Calibration Complete** to complete the S21 calibration, and the calibration data are saved. After the calibration is completed, the tick icon ✓ following the specified calibration turns green.

Apply the Calibration

Click or tap **Apply** to complete the S-parameter calibration.

7.12.2.3 Loss Test

After completing the S11 and S21 parameter calibration, start the S-parameter loss test.

Connect the Devices

Connect the devices according to the connection diagram shown in the figure below.

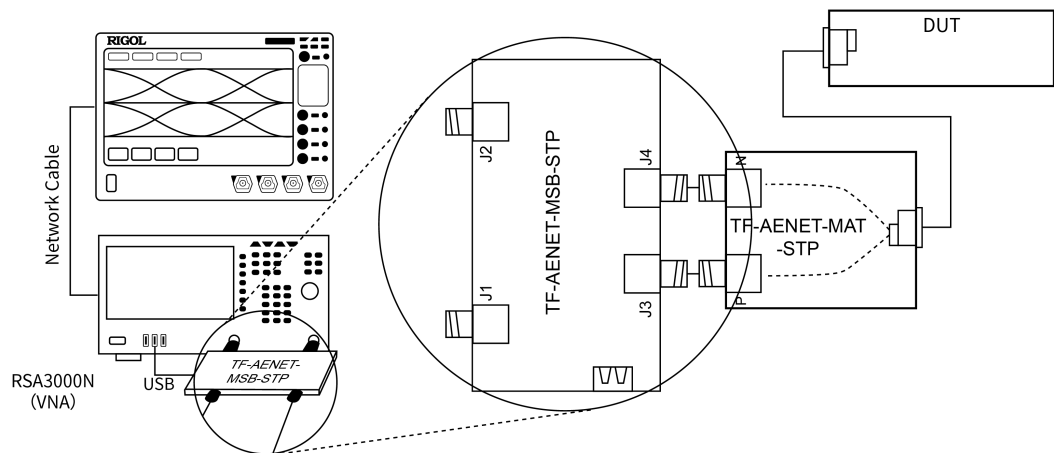

Figure 7.14 Test Connection Diagram

- Connect Port J1 and Port J2 of the Fixture TF-AENET-MSB-STP (matrix switching) to the RF input terminal and tracking generator (TG) output terminal of the RSA3000N spectrum analyzer respectively via the SMA adaptor.
- Connect Port J3 and Port J4 of the Fixture TF-AENET-MSB-STP (matrix switching) to the SMA interface of the Fixture TF-AENET-MAT-STP by using the adaptor.
- Connect the DUT to the MDI interface of the Fixture TF-AENET-MAT-STP (adaptor board) by using the network cable.
- Set the dip switch on the fixture TF-AENET-MSB-STP to a downward position.

Test Procedures

1. Click or tap the **Configuration** tab to enter the "Configuration" menu. Then click or tap **Test** to start testing.
2. Set the dip switch on the fixture to an upward position according to the displayed prompt message, and then complete loading the calibration data files.
3. After finishing the test, you can view the test results in the "100Base-T Test Results" window.

7.13 100Base-T1 MDI Mode Conversion Loss

For the MDI Mode Conversion Loss test, use the fixture TF-AENET-MSB-STP (matrix switching) and TF-AENET-MAT-STP (adaptor board).

The test methods of MDI Mode Conversion Loss is the same as that of *100Base-T1 MDI Return Loss*. You can select VNA or RIGOL's RSA3000N series spectrum analyzer, depending on your actually available device, to perform the test. Two available test methods are available: offline import and online configuration.

This section introduces the test by taking RIGOL DS70000 and RSA3000N series as an example.

Offline Import

Please refer to *Offline Import* for the 100Base-T1 MDI Mode Conversion Loss test to perform the test and generate the analysis report.

Online Configuration

1. In the DS70000 operation interface, click or tap  > **AETH** to enter the "Automotive Ethernet Test" menu.
2. Click or tap **Test Item** > **100Base-T1 Tests** > **MDI Mode Conversion Loss** to select the MDI Mode Conversion Loss test.
3. Please refer to *Online Configuration* for the 100Base-T1 MDI Mode Conversion Loss test to perform the test.

8 1000Base-T1 (IEEE Std 802.3bp)

The following table shows the test modes and test items under each test mode and their reference standards.

1000Base-T1 Test Item		Reference Standard
Test Mode 1	Master Timing Jitter	IEEE 802.3bp-2016 97.5.3.3
	Slave Timing Jitter	IEEE 802.3bp-2016 97.5.3.3
Test Mode 2	MDI Output Jitter	IEEE 802.3bp-2016 97.5.3.3
	Transmit Clock Frequency	IEEE 802.3bp-2016 97.5.3.6
Test Mode 4	Transmitter Distortion	IEEE 802.3bp-2016 97.5.3.2
	MDI Return Loss	IEEE 802.3bp-2016 97.7.2.1
	MDI Mode Conversion Loss	IEEE 802.3bp-2016 97.7.2.2
Test Mode 5	Power Spectral Density	IEEE 802.3bp-2016 97.5.3.4
	Peak Differential Output	IEEE 802.3bp-2016 97.5.3.5
Test Mode 6	Transmitter Output Droop	IEEE 802.3bp-2016 97.5.3.1

8.1 1000Base-T1 Master Timing Jitter (Without the Clock)

For 1000Base-T1 Master Timing Jitter (Without the Clock), use the test fixture TF-AENET-MAT-STP (adaptor board) and the test fixture TF-AENET-MB-STP Section3 (breakout board) to perform the test. This section introduces the test by taking RIGOL DS70000 series oscilloscope as an example.

Select the Signal Type and Test Item

- Click or tap **AETH** to enter the Automotive Ethernet Test interface of the DS70000 series. Click or tap the **System Settings** tab to enter the system setting menu.
 - Click or tap to select **IEEE** as the specification, and **1000Mbps** as the signal rate.
 - Click or tap to select **Single Differential Signal** for the signal type.
 - Uncheck the checkbox of "Use TX_TCLK(Test Mode 1)".

- Check the checkbox of "2MHz Bandpass Filter" to filter the test signal, the signal noise can be reduced and the test results are optimized.

2. Click or tap **Test Item** > **1000Base-T1 Tests** > **Test Mode 1** > **Master Timing Jitter** to select the Master Timing Jitter test.

Connect the Device

Refer to *Figure 7.1* to connect the oscilloscope, the fixture, and the DUT.

Test Procedures

1. Set the DUT as the master and set it to generate a Test Mode 1 signal.
2. Configure the DS70000 oscilloscope. Click or tap the function navigation icon and then select "AETH" to enter the "Automotive Ethernet Test" menu. In the "System Settings" tab, select the signal type according to the actual device connection.
3. Click or tap **View Wfm** to preview the waveform for the specified test item in the waveform view to ensure that the waveform is properly output.
4. Click or tap **Test** to start testing. The "Compliance Analysis" dialog box is displayed. Wait for its analysis result.
5. After finishing the analysis, you can view the test results in the "1000Base-T1 Results" window.

8.2 1000Base-T1 Master Timing Jitter (With the Clock)

For 1000Base-T1 Test Mode 1 Master Timing Jitter (With the Clock), the fixture is not required for this test. This section introduces the test by taking RIGOL DS70000 series oscilloscope as an example.

Select the Signal Type and Test Item

1. Click or tap **AETH** to enter the Automotive Ethernet Test interface of the DS70000 series. Click or tap the **System Settings** tab to enter the system setting menu.
 - Click or tap to select **IEEE** as the specification, and **1000Mbps** as the signal rate.
 - Click or tap to select **Single Differential Signal** for the signal type.
 - Check the checkbox of "Use TX_TCLK(Test Mode 1)".

- Check the checkbox of "2MHz Bandpass Filter" to filter the test signal, the signal noise can be reduced and the test results are optimized.

2. Click or tap **Test Item** > **1000Base-T1 Tests** > **Test Mode 1** > **Master Timing Jitter** to select the Master Timing Jitter test.

Connect the Device

For different signal types, the test connection diagrams are different.

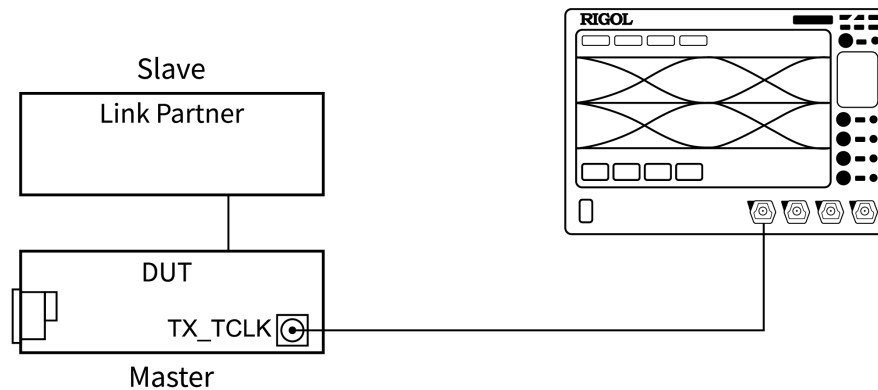

Figure 8.1 Test Connection Diagram

- Connect the DUT with the Link Partner. Set the DUT to Master and the Link Partner to Slave.
- Connect the clock interface (TX_TCLK) of the master DUT to the analog channel of the oscilloscope by using the BNC-to-SMA cable.

Test Procedures

1. Set the DUT as the master and set it to generate a Test Mode 1 signal.
2. Configure the DS70000 oscilloscope. Click or tap the function navigation icon and then select "AETH" to enter the "Automotive Ethernet Test" menu. In the "System Settings" tab, select the signal type according to the actual device connection.
3. Click or tap **View Wfm** to preview the waveform for the specified test item in the waveform view to ensure that the waveform is properly output.
4. Click or tap **Test** to start testing. The "Compliance Analysis" dialog box is displayed. Wait for its analysis result.

5. After finishing the analysis, you can view the test results in the "1000Base-T1 Results" window.

8.3 1000Base-T1 Slave Timing Jitter (Without the Clock)

For 1000Base-T1 Slave Timing Jitter (Without the Clock), use the test fixture TF-AENET-MAT-STP (adaptor board) and the test fixture TF-AENET-MB-STP Section3 (breakout board) to perform the test. This section introduces the test by taking RIGOL DS70000 series oscilloscope as an example.

Select the Signal Type and Test Item

1. Click or tap **AETH** to enter the Automotive Ethernet Test interface of the DS70000 series. Click or tap the **System Settings** tab to enter the system setting menu.
 - Click or tap to select **IEEE** as the specification, and **1000Mbps** as the signal rate.
 - Click or tap to select **Single Differential Signal** for the signal type.
 - Uncheck the checkbox of "Use TX_TCLK(Test Mode 1)".
 - Check the checkbox of "2MHz Bandpass Filter" to filter the test signal, the signal noise can be reduced and the test results are optimized.
2. Click or tap **Test Item** > **1000Base-T1 Tests** > **Test Mode 1** > **Slave Timing Jitter** to select the Slave Timing Jitter test.

Connect the Device

Refer to *Figure 7.1* to connect the oscilloscope, the fixture, and the DUT.

Test Procedures

1. Set the DUT as the slave and set it to generate a Test Mode 1 signal.
2. Configure the DS70000 oscilloscope. Click or tap the function navigation icon and then select "AETH" to enter the "Automotive Ethernet Test" menu. In the "System Settings" tab, select the signal type according to the actual device connection.
3. Click or tap **View Wfm** to preview the waveform for the specified test item in the waveform view to ensure that the waveform is properly output.
4. Click or tap **Test** to start testing. The "Compliance Analysis" dialog box is displayed. Wait for its analysis result.

5. After finishing the analysis, you can view the test results in the "1000Base-T1 Results" window.

8.4 1000Base-T1 Slave Timing Jitter (With the Clock)

For 1000Base-T1 Slave Timing Jitter (With the Clock), use the test fixture TF-AENET-MAT-STP (adaptor board) and the test fixture TF-AENET-MB-STP Section3 (breakout board) to perform the test. This section introduces the test by taking RIGOL DS70000 series oscilloscope as an example.

Select the Signal Type and Test Item

1. Click or tap **AETH** to enter the Automotive Ethernet Test interface of the DS70000 series. Click or tap the **System Settings** tab to enter the system setting menu.
 - Click or tap to select **IEEE** as the specification, and **1000Mbps** as the signal rate.
 - Click or tap to select **Single Differential Signal** for the signal type.
 - Check the checkbox of "Use TX_TCLK(Test Mode 1)".
 - Check the checkbox of "2MHz Bandpass Filter" to filter the test signal, the signal noise can be reduced and the test results are optimized.
2. Click or tap **Test Item** > **1000Base-T1 Tests** > **Test Mode 1** > **Slave Timing Jitter** to select the Slave Timing Jitter test.

Connect the Device

Refer to *Figure 7.1* to connect the oscilloscope, the fixture, and the DUT.

Test Procedures

1. Set the Link Partner as the master and the DUT as the slave. Set it to generate a Test Mode 1 signal.
2. Configure the DS70000 oscilloscope. Click or tap the function navigation icon and then select "AETH" to enter the "Automotive Ethernet Test" menu. In the "System Settings" tab, select the signal type according to the actual device connection.
3. Click or tap **View Wfm** to preview the waveform for the specified test item in the waveform view to ensure that the waveform is properly output.
4. Click or tap **Test** to start testing. The "Compliance Analysis" dialog box is displayed. Wait for its analysis result.

5. After finishing the analysis, you can view the test results in the "1000Base-T1 Results" window.

8.5 1000Base-T1 MDI Jitter

For 1000Base-T1 Test Mode 2 MDI Jitter, use the test fixture TF-AENET-MAT-STP (adaptor board) and the test fixture TF-AENET-MB-STP Section3 (breakout board) to perform the test. This section introduces the test by taking RIGOL DS70000 series oscilloscope as an example.

Select the Signal Type and Test Item

1. In the DS70000 operation interface, click or tap  > **AETH** to enter the "Automotive Ethernet Test" menu.
2. Click or tap **System Settings** to enter system setting menu.
 - Click or tap to select **IEEE** as the specification, and **1000Mbps** as the signal rate.
 - Click or tap to select **Single Differential Signal** for the signal type.
 - Check the checkbox of "2MHz Bandpass Filter" to filter the test signal, the signal noise can be reduced and the test results are optimized.
3. Click or tap **Test Item** > **1000Base-T1 Tests** > **Test Mode 2** > **MDI Output Jitter** to select the MDI Output Jitter test.

Connect the Device

Refer to [Figure 7.1](#) to connect the oscilloscope, the fixture, and the DUT.

Test Procedures

1. Set the DUT as the master and set it to generate a Test Mode 2 signal.
2. Configure the DS70000 oscilloscope. Click or tap the function navigation icon and then select "AETH" to enter the "Automotive Ethernet Test" menu. In the "System Settings" tab, select the signal type according to the actual device connection.
3. Click or tap **View Wfm** to preview the waveform for the specified test item in the waveform view to ensure that the waveform is properly output.
4. Click or tap **Test** to start testing. The "Compliance Analysis" dialog box is displayed. Wait for its analysis result.

5. After finishing the analysis, you can view the test results in the "1000Base-T1 Results" window.

8.6 1000Base-T1 Transmit Clock Frequency

For 1000Base-T1 Test Mode 2 Transmit Clock Frequency, use the test fixture TF-AENET-MAT-STP (adaptor board) and the test fixture TF-AENET-MB-STP Section3 (breakout board) to perform the test. This section introduces the test by taking RIGOL DS70000 series oscilloscope as an example.

Select the Signal Type and Test Item

1. In the DS70000 operation interface, click or tap  > **AETH** to enter the "Automotive Ethernet Test" menu.
2. Click or tap **System Settings** to enter system setting menu.
 - Click or tap to select **IEEE** as the specification, and **1000Mbps** as the signal rate.
 - Click or tap to select **Two Single Signals** or **Single Differential Signal** for the signal type.
3. Click or tap **Test Item** > **1000Base-T1 Tests** > **Test Mode 2** > **Transmit Clock Frequency** to select the Transmit Clock Frequency test.

Connect the Device

For different signal types, the test connection diagrams are different. For the connection diagram, refer to [Connect the Device](#).

Test Procedures

Refer to [Test Procedures](#) to complete the test.

8.7 1000Base-T1 Transmitter Distortion (Without Disturbing Signal, Without Reference Clock)

For 1000Base-T1 Test Mode 4 Transmitter Distortion (Without Disturbing Signal, Without Reference Clock), use the test fixture TF-AENET-MAT-STP (adaptor board) to perform the test in a scenario without the disturbing signal and without the reference clock. This section takes RIGOL DS70000 series oscilloscope as an example.

Select the Signal Type and Test Item

1. In the DS70000 operation interface, click or tap  > **AETH** to enter the "Automotive Ethernet Test" menu.

2. Click or tap **System Settings** to enter system setting menu.
 - Click or tap to select **IEEE** as the specification, and **1000Mbps** as the signal rate.
 - Click or tap to select **Two Single Signals** for the signal type.
 - In the **System Settings** tab, uncheck the checkbox of "Use Disturbing Signal" and uncheck the checkbox of "Use 10 MHz Ref Clock For Synchronization".
3. Click or tap **Test Item** > **1000Base-T1 Tests** > **Test Mode 4** > **Transmitter Distortion** to select the Transmitter Distortion test.

Connect the Device

Refer to *Figure 7.2* to connect the oscilloscope, the fixture, and the DUT.

Test Procedures

1. Set the DUT as the master and set it to generate a Test Mode 4 signal.
2. In the "Configuration" menu of DS70000 Automotive Ethernet Test, click or tap the drop-down button of **Dp Source** to select CH1. Click or tap the drop-down button of **Dn Source** to select CH3. Ensure that the selected channels are consistent with those you select for the device in the connection diagram.
3. Click or tap **View Wfm** to preview the waveform for the specified test item in the waveform view to ensure that the waveform is properly output.
4. Click or tap **Test** to start testing. The "Compliance Analysis" dialog box is displayed. Wait for its analysis result.
5. After finishing the analysis, you can view the test results in the "1000Base-T1 Results" window.

8.8 1000Base-T1 Transmitter Distortion (Without Disturbing Signal, With Reference Clock)

For 1000Base-T1 Test Mode 4 Transmitter Distortion (Without Disturbing Signal, With Reference Clock), use the test fixture TF-AENET-MAT-STP (adaptor board) and the test fixture TF-AENET-FDB-STP (frequency divider board) to perform the test in a scenario without the disturbing signal and with the reference clock. This section takes RIGOL DS70000 series oscilloscope as an example.

Select the Signal Type and Test Item

1. In the DS70000 operation interface, click or tap  > **AETH** to enter the "Automotive Ethernet Test" menu.
2. Click or tap **System Settings** to enter system setting menu.
 - Click or tap to select **IEEE** as the specification, and **1000Mbps** as the signal rate.
 - Click or tap to select **Two Single Signals** for the signal type.
 - In the **System Settings** tab, uncheck the checkbox of "Use Disturbing Signal" and check the checkbox of "Use 10 MHz Ref Clock For Synchronization".
3. Click or tap **Test Item** > **1000Base-T1 Tests** > **Test Mode 4** > **Transmitter Distortion** to select the transmitter distortion test.

Connect the Device

Refer to *Figure 7.9* to connect the oscilloscope, the fixture, and the DUT.

Test Procedures

1. Set the DUT as the master and set it to generate a Test Mode 4 signal.
2. In the "Configuration" menu of DS70000 Automotive Ethernet Test, click or tap the drop-down button of **Dp Source** to select CH1. Click or tap the drop-down button of **Dn Source** to select CH3. Ensure that the selected channels are consistent with those you select for the device in the connection diagram.
3. Click or tap **View Wfm** to preview the waveform for the specified test item in the waveform view to ensure that the waveform is properly output.
4. Click or tap **Test** to start testing. The "Compliance Analysis" dialog box is displayed. Wait for its analysis result.
5. After finishing the analysis, you can view the test results in the "1000Base-T1 Results" window.

8.9 1000Base-T1 Transmitter Distortion (With Disturbing Signal, Without Reference Clock)

For 1000Base-T1 Test Mode 4 Transmitter Distortion (With Disturbing Signal, Without Reference Clock), use the test fixture TF-AENET-MAT-STP (adaptor board), the test fixture TF-AENET-MB-STP Section2 (breakout board), and the test fixture TF-AENET-

PAB-STP (preamplifier board) to perform the test in a scenario with the disturbing signal and without the reference clock. This section introduces the test by taking RIGOL DS70000 series oscilloscope as an example.

Select the Signal Type and Test Item

1. In the DS70000 operation interface, click or tap  > **AETH** to enter the "Automotive Ethernet Test" menu.
2. Click or tap **System Settings** to enter system setting menu.
 - Click or tap to select **IEEE** as the specification, and **1000Mbps** as the signal rate.
 - Click or tap to select **Two Single Signals** for the signal type.
 - In the **System Settings** tab, check the checkbox of "Use Disturbing Signal" and uncheck the checkbox of "Use 10 MHz Ref Clock For Synchronization".
3. Click or tap **Test Item** > **1000Base-T1 Tests** > **Test Mode 4** > **Transmitter Distortion** to select the transmitter distortion test.

Calibrate the Disturbing Signal and the Fixture

Refer to *To Calibrate the Disturbing Signal* to calibrate the disturbing signal.

Refer to *Fixture Calibration* to calibrate the fixture.

Connect the Device

Refer to *Figure 7.8* to connect the oscilloscope, the function/arbitrary waveform generator, the fixture, and the DUT.

Test Procedures

1. Set the DUT as the master and set it to generate a Test Mode 4 signal.
2. Configure the DS70000 oscilloscope.
 - a. After selecting a test item, click or tap the **Configuration** tab to enter the Configuration menu.
 - b. In the "Configuration" menu, click or tap the drop-down button of **Dp Source** to select CH1. Click or tap the drop-down button of **Dn Source** to select CH3. Ensure that the selected channels are consistent with those you select for the device in the connection diagram.
3. Click or tap **View Wfm** to preview the waveform for the specified test item in the waveform view to ensure that the waveform is properly output.

4. Click or tap **Test** to start testing. The "Compliance Analysis" dialog box is displayed. Wait for its analysis result.
5. After finishing the analysis, you can view the test results in the "1000Base-T1 Results" window.

8.10 1000Base-T1 Transmitter Distortion (With Disturbing Signal, With Reference Clock)

For 1000Base-T1 Test Mode 4 Transmitter Distortion (With Disturbing Signal, With Reference Clock), use the test fixture TF-AENET-MAT-STP (adaptor board), the test fixture TF-AENET-MB-STP Section2 (breakout board), and the test fixture TF-AENET-PAB-STP (preamplifier board) to perform the test in a scenario with the disturbing signal and with the reference clock. This section introduces the test by taking RIGOL DS70000 series oscilloscope as an example.

Select the Signal Type and Test Item

1. In the DS70000 operation interface, click or tap  > **AETH** to enter the "Automotive Ethernet Test" menu.
2. Click or tap **System Settings** to enter system setting menu.
 - Click or tap to select **IEEE** as the specification, and **1000Mbps** as the signal rate.
 - Click or tap to select **Two Single Signals** for the signal type.
 - In the **System Settings** tab, check the checkbox of "Use Disturbing Signal" and check the checkbox of "Use 10 MHz Ref Clock For Synchronization".
3. Click or tap **Test Item** > **1000Base-T1 Tests** > **Test Mode 4** > **Transmitter Distortion** to select the transmitter distortion test.

Calibrate the Disturbing Signal and the Fixture

Refer to *To Calibrate the Disturbing Signal* to calibrate the disturbing signal.

Refer to *Fixture Calibration* to calibrate the fixture.

Connect the Device

Refer to *Figure 7.7* to connect the oscilloscope, the function/arbitrary waveform generator, the fixture, and the DUT.

Test Procedures

1. Set the DUT as the master and set it to generate a Test Mode 4 signal.

2. Configure the DS70000 oscilloscope.
 - a. After selecting a test item, click or tap the **Configuration** tab to enter the Configuration menu.
 - b. In the "Configuration" menu, click or tap the drop-down button of **Dp Source** to select CH1. Click or tap the drop-down button of **Dn Source** to select CH3. Ensure that the selected channels are consistent with those you select for the device in the connection diagram.
3. Click or tap **View Wfm** to preview the waveform for the specified test item in the waveform view to ensure that the waveform is properly output.
4. Click or tap **Test** to start testing. The "Compliance Analysis" dialog box is displayed. Wait for its analysis result.
5. After finishing the analysis, you can view the test results in the "1000Base-T1 Results" window.

8.11 1000Base-T1 MDI Return Loss

For the 1000Base-T1 MDI Return Loss test, use the fixture TF-AENET-MSB-STP (matrix switching) and TF-AENET-MAT-STP (adaptor board). RIGOL DS70000 series oscilloscope can work with VNA or RIGOL RSA3000N series equipped with the VNA mode to perform the MDI return loss test. The following test schemes are available.

- **Vector Network Analyzer (VNA)**

Use a VNA device to perform the loss test. Then export the measurement data generated from the VNA device to the oscilloscope to perform the compliance analysis. Generate the analysis report.

- **Real-time spectrum analyzer with VNA mode**

RIGOL's RSA3000N series spectrum analyzer is recommended.

- **Online configuration:** Build network connection between the oscilloscope and the spectrum analyzer. Then control the spectrum analyzer to complete the calibration and measurement operation through the oscilloscope. After finishing the measurement, the oscilloscope reads the measurement data, makes an analysis, and generates the analysis report.

- **Offline import:** Use the VNA mode of the RSA3000N series spectrum analyzer to perform the loss test. Import the measurement data generated from the spectrum analyzer to the oscilloscope offline to perform the compliance analysis. Then generate the analysis report.

The test methods of the 1000Base-T1 MDI Return Loss are the same as that of *100Base-T1 MDI Return Loss*.

Offline Import

Please refer to *Offline Import* to perform the test and generate the analysis report.

Online Configuration

1. In the DS70000 operation interface, click or tap  > **AETH** to enter the "Automotive Ethernet Test" menu.
2. Click or tap to select **IEEE** as the specification, and **1000Mbps** as the signal rate.
 - Click or tap to select **Two Single Signals** for the signal type.
 - In the "System Settings" tab, select "RSA" under **Device Select**. Then click or tap the input field of **IP Address**, then the interface is displayed, prompting you to input the IP address of the RSA device with the pop-up numeric keypad. If successfully connected, **Connection Status** shows "Connected".
3. Click or tap **Test Item** > **1000Base-T1 Tests** > **MDI Return Loss** to select the MDI Return Loss test.
4. Refer to *S-Parameter Calibration* to complete the calibration.
5. Refer to *Loss Test* to complete the MDI return loss test.

8.12 1000Base-T1 MDI Mode Conversion Loss

For the 1000Base-T1 MDI Mode Conversion Loss test, use the fixture TF-AENET-MSB-STP (matrix switching) and TF-AENET-MAT-STP (adaptor board). RIGOL DS70000 series oscilloscope can work with VNA or RIGOL RSA3000N series equipped with the VNA mode to perform MDI mode conversion loss test. The following test schemes are available.

- **Vector Network Analyzer (VNA)**

Use a VNA device to perform the loss test. Then export the measurement data generated from the VNA device to the oscilloscope to perform the compliance analysis. Generate the analysis report.

- **Real-time spectrum analyzer with VNA mode**

RIGOL's RSA3000N series spectrum analyzer is recommended.

- **Online configuration:** Build network connection between the oscilloscope and the spectrum analyzer. Then control the spectrum analyzer to complete the calibration and measurement operation through the oscilloscope. After finishing the measurement, the oscilloscope reads the measurement data, makes an analysis, and generates the analysis report.
- **Offline import:** Use the VNA mode of the RSA3000N series spectrum analyzer to perform the loss test. Import the measurement data generated from the spectrum analyzer to the oscilloscope offline to perform the compliance analysis. Then generate the analysis report.

The test methods of the 1000Base-T1 MDI Mode Conversion Loss are the same as that of *100Base-T1 MDI Return Loss*.

Offline Import

Please refer to *Offline Import* to perform the test and generate the analysis report.

Online Configuration

1. In the DS70000 operation interface, click or tap  > **AETH** to enter the "Automotive Ethernet Test" menu.
2. Click or tap to select **IEEE** as the specification, and **1000Mbps** as the signal rate.
 - Click or tap to select **Two Single Signals** for the signal type.
 - In the "System Settings" tab, select "RSA" under **Device Select**. Then click or tap the input field of **IP Address**, then the interface is displayed, prompting you to input the IP address of the RSA device with the pop-up numeric keypad. If successfully connected, **Connection Status** shows "Connected".
3. Click or tap **Test Item** > **1000Base-T1 Tests** > **MDI Mode Conversion Loss** to select the MDI Mode Conversion Loss test.

4. Refer to *S-Parameter Calibration* to complete the calibration.
5. Refer to *Loss Test* to complete the mode conversion loss test.

8.13 1000Base-T1 Power Spectral Density

For 1000Base-T1 Test Mode 5 Power Spectral Density test, use the test fixture TF-AENET-MAT-STP (adaptor board) and the test fixture TF-AENET-MB-STP Section3 (breakout board) to perform the test. This section introduces the test by taking RIGOL DS70000 series oscilloscope as an example.

Select the Signal Type and Test Item

1. In the DS70000 operation interface, click or tap  > **AETH** to enter the "Automotive Ethernet Test" menu.
2. Click or tap **System Settings** to enter system setting menu.
Click or tap to select **IEEE** as the specification, and **1000Mbps** as the signal rate.
Click or tap to select **Single Differential Signal** as the signal type.
3. Click or tap **Test Item** > **1000Base-T1 Tests** > **Test Mode 5** > **Power Spectral Density** to select the Power Spectral Density test.

Connect the Device

Refer to *Figure 7.1* to connect the oscilloscope, the fixture, and the DUT.

Test Procedures

1. Set the DUT as the master and set it to generate a Test Mode 5 signal.
2. Configure the DS70000 oscilloscope. Click or tap the function navigation icon and then select "AETH" to enter the "Automotive Ethernet Test" menu. In the **System Settings** tab, select the desired signal type. Then in the **Configuration** tab, select the specified channel source of the signal according to the actual device connection.
3. Click or tap **View Wfm** to preview the waveform for the specified test item in the waveform view to ensure that the waveform is properly output.
4. Click or tap **Test** to start testing. The "Compliance Analysis" dialog box is displayed. Wait for its analysis result.
5. After finishing the analysis, you can view the test results in the "1000Base-T1 Results" window.

8.14 1000Base-T1 Peak Differential Output

For 1000Base-T1 Test Mode 5 Peak Differential Output test, use the test fixture TF-AENET-MAT-STP (adaptor board) and the test fixture TF-AENET-MB-STP Section3 (breakout board) to perform the test. This section introduces the test by taking RIGOL DS70000 series oscilloscope as an example.

Select the Signal Type and Test Item

1. In the DS70000 operation interface, click or tap  > **AETH** to enter the "Automotive Ethernet Test" menu.
2. Click or tap **System Settings** to enter system setting menu.
 - Click or tap to select **IEEE** as the specification, and **1000Mbps** as the signal rate.
 - Click or tap to select **Two Single Signals** or **Single Differential Signal** for the signal type.
3. Click or tap **Test Item** > **1000Base-T1 Tests** > **Test Mode 5** > **Peak Differential Output** to select the Peak Differential Output test.

Connect the Device

For different signal types, the test connection diagrams are different. For the connection diagram, refer to *Connect the Device*.

Test Procedures

Refer to *Test Procedures* to complete the test.

8.15 1000Base-T1 Transmitter Output Droop

For 1000Base-T1 Test Mode 6 Transmitter Output Droop test, use the test fixture TF-AENET-MAT-STP (adaptor board) to perform the test. This section introduces the test by taking RIGOL DS70000 series oscilloscope as an example.

Select the Signal Type and Test Item

1. In the DS70000 operation interface, click or tap  > **AETH** to enter the "Automotive Ethernet Test" menu.
2. Click or tap **System Settings** to enter system setting menu.
 - Click or tap to select **IEEE** as the specification, and **1000Mbps** as the signal rate.
 - Click or tap to select **Two Single Signals** or **Single Differential Signal** for the signal type.

3. Click or tap **Test Item** > **1000Base-T1 Tests** > **Test Mode 6** > **Transmitter Output Droop** to select the Transmitter Output Droop test.

Connect the Device

For different signal types, the test connection diagrams are different. For the connection diagram, refer to *Connect the Device*.

Test Procedures

1. Set the DUT as the master and set it to generate a Test Mode 6 signal.
2. Configure the DS70000 oscilloscope. Click or tap the function navigation icon and then select "AETH" to enter the "Automotive Ethernet Test" menu. In the **System Settings** tab, select the desired signal type. Then in the **Configuration** tab, select the specified channel source of the signal according to the actual device connection.
3. Click or tap **View Wfm** to preview the waveform for the specified test item in the waveform view to ensure that the waveform is properly output.
4. Click or tap **Test** to start testing. The "Compliance Analysis" dialog box is displayed. Wait for its analysis result.
5. After finishing the analysis, you can view the test results in the "1000Base-T1 Results" window.

9 100Base-T1 (Open Alliance TC8)

The following table shows the test modes and test items under each test mode and their reference standards.

Table 9.1 100Base-T1 (Open Alliance TC8)

Test Mode	Test Contents
OABR_PMA_TX_01	Transmitter Output Droop
OABR_PMA_TX_02	Master Timing Jitter
OABR_PMA_TX_03	Transmit Clock Frequency
OABR_PMA_TX_04	Power Spectral Density
OABR_PMA_TX_05	MDI Return Loss
OABR_PMA_TX_06	MDI Mode Conversion Loss
OABR_PMA_TX_07	MDI Common Mode Emission
OABR_PMA_TX_08	Transmitter Distortion

9.1 100Base-T1(ECU) Transmitter Output Droop

For 100Base-T1(ECU) Transmitter Output Droop test, use the test fixture TF-AENET-MAT-STP (adaptor board) and the test fixture TF-AENET-MB-STP Section3 (breakout board) to perform the test. This section introduces the test by taking RIGOL DS70000 series oscilloscope as an example.

Select the Signal Type and Test Item

1. In the DS70000 operation interface, click or tap  > **AETH** to enter the "Automotive Ethernet Test" menu.
2. Click or tap **System Settings** to enter system setting menu.
 - Click or tap to select **Open Alliance** as the specification, and **100Mbps** as the signal rate.
 - Click or tap to select **Two Single Signals** or **Single Differential Signal** for the signal type.

- Click or tap **Test Item** > **100Base-T1(ECU) Tests** > **OABR_PMA_TX_01(TM1)** > **Transmitter Output Droop** to select the Transmitter Output Droop test.

Connect the Device

For different signal types, the test connection diagrams are different. For the connection diagram, refer to *Connect the Device*.

Test Procedures

Refer to *Test Procedures* to complete the test.

9.2 100Base-T1(ECU) Transmitter Timing Jitter(Master)

For 100Base-T1(ECU) Transmitter Timing Jitter(Master) test, use the test fixture TF-AENET-MAT-STP (adaptor board) and the test fixture TF-AENET-MB-STP Section3 (breakout board) to perform the test. This section introduces the test by taking RIGOL DS70000 series oscilloscope as an example.

Select the Signal Type and Test Item

- In the DS70000 operation interface, click or tap  > **AETH** to enter the "Automotive Ethernet Test" menu.
- Click or tap **System Settings** to enter system setting menu.
 - Click or tap to select **Open Alliance** as the specification, and **100Mbps** as the signal rate.
 - Click or tap to select **Single Differential Signal** for the signal type.
- Click or tap **Test Item** > **100Base-T1(ECU) Tests** > **OABR_PMA_TX_02(TM2)** > **Transmitter Timing Jitter(Master)** to select the Transmitter Timing Jitter(Master) test.

Connect the Device

Refer to *Figure 7.1* to connect the oscilloscope, the fixture, and the DUT.

Test Procedures

Refer to *Test Procedures* to complete the test.

9.3 100Base-T1(ECU) Transmit Clock Frequency

For 100Base-T1(ECU) Transmit Clock Frequency test, use the test fixture TF-AENET-MAT-STP (adaptor board) and the test fixture TF-AENET-MB-STP Section3 (breakout board) to perform the test. This section introduces the test by taking RIGOL DS70000 series oscilloscope as an example.

Select the Signal Type and Test Item

1. In the DS70000 operation interface, click or tap  > **AETH** to enter the "Automotive Ethernet Test" menu.
2. Click or tap **System Settings** to enter system setting menu.
 - Click or tap to select **Open Alliance** as the specification, and **100Mbps** as the signal rate.
 - Click or tap to select **Two Single Signals** or **Single Differential Signal** for the signal type.
3. Click or tap **Test Item** > **100Base-T1(ECU) Tests** > **OABR_PMA_TX_03(TM2)** > **Transmit Clock Frequency** to select the Transmit Clock Frequency test.

Connect the Device

For different signal types, the test connection diagrams are different. For the connection diagram, refer to *Connect the Device*.

Test Procedures

Refer to *Test Procedures* to complete the test.

9.4 100Base-T1(ECU) Power Spectral Density

For 100Base-T1(ECU) Power Spectral Density test, use the test fixture TF-AENET-MAT-STP (adaptor board) and the test fixture TF-AENET-MB-STP Section3 (breakout board) to perform the test. This section introduces the test by taking RIGOL DS70000 series oscilloscope as an example.

Select the Signal Type and Test Item

1. In the DS70000 operation interface, click or tap  > **AETH** to enter the "Automotive Ethernet Test" menu.
2. Click or tap **System Settings** to enter system setting menu.
 - Click or tap to select **Open Alliance** as the specification, and **100Mbps** as the signal rate.
 - Click or tap to select **Single Differential Signal** for the signal type.
3. Click or tap **Test Item** > **100Base-T1(ECU) Tests** > **OABR_PMA_TX_04(TM5)** > **Power Spectral Density** to select the Power Spectral Density test.

Connect the Device

Refer to [Figure 7.1](#) to connect the oscilloscope, the fixture, and the DUT.

Test Procedures

1. Set the DUT as the master and set it to generate a Test Mode 5 signal.
2. Configure the DS70000 oscilloscope. Click or tap the function navigation icon and then select "AETH" to enter the "Automotive Ethernet Test" menu. In the **System Settings** tab, select the desired signal type. Then in the **Configuration** tab, select the specified channel source of the signal according to the actual device connection.
3. Click or tap **View Wfm** to preview the waveform for the specified test item in the waveform view to ensure that the waveform is properly output.
4. Click or tap **Test** to start testing. The "Compliance Analysis" dialog box is displayed. Wait for its analysis result.
5. After finishing the analysis, you can view the test results in the "100Base-T1 Results" window.

9.5 100Base-T1(ECU) Return Loss

For the 100Base-T1(ECU) Return Loss test, use the fixture TF-AENET-MSB-STP (matrix switching) and TF-AENET-MAT-STP (adaptor board).

The test methods of the 100Base-T1(ECU) MDI Return Loss are the same as that of [100Base-T1 MDI Return Loss](#). DS70000 series oscilloscope can work with the VNA device or RIGOL's RSA3000N series equipped with the VNA mode to perform the Return Loss test. The following test schemes are available.

- **Vector Network Analyzer (VNA)**

Use a VNA device to perform the loss test. Then export the measurement data generated from the VNA device to the oscilloscope to perform the compliance analysis. Generate the analysis report.

- **Real-time spectrum analyzer with VNA mode**

RIGOL's RSA3000N series spectrum analyzer is recommended.

- **Online configuration:** Build network connection between the oscilloscope and the spectrum analyzer. Then control the spectrum analyzer to complete

the calibration and measurement operation through the oscilloscope. After finishing the measurement, the oscilloscope reads the measurement data, makes an analysis, and generates the analysis report.

- **Offline import:** Use the VNA mode of the RSA3000N series spectrum analyzer to perform the loss test. Import the measurement data generated from the spectrum analyzer to the oscilloscope offline to perform the compliance analysis. Then generate the analysis report.

Offline Import

Please refer to *Offline Import* to perform the test and generate the analysis report.

Online Configuration

The RSA3000N series spectrum analyzer allows you to use the online configuration methods to perform the return loss test.

1. In the DS70000 operation interface, click or tap  > **AETH** to enter the "Automotive Ethernet Test" menu.
2. Click or tap to select **Open Alliance** as the specification, and **100Mbps** as the signal rate.
 - Click or tap to select **Two Single Signals** for the signal type.
 - In the "System Settings" tab, select "RSA" under **Device Select**. Then click or tap the input field of **IP Address**, then the interface is displayed, prompting you to input the IP address of the RSA device with the pop-up numeric keypad. If successfully connected, **Connection Status** shows "Connected".
3. Click or tap **Test Item** > **100Base-T1(ECU) Tests** > **OABR_PMA_TX_05** > **MDI Return Loss** to select the MDI Return Loss test.
4. Refer to *S-Parameter Calibration* to complete the calibration.
5. Refer to *Loss Test* to complete the MDI return loss test.

9.6 100Base-T1(ECU) MDI Mode Conversion Loss

For the 100Base-T1(ECU) MDI Mode Conversion Loss test, use the fixture TF-AENET-MSB-STP (matrix switching) and TF-AENET-MAT-STP (adaptor board).

The test methods of 100Base-T1(ECU) MDI Mode Conversion Loss are the same as that of *100Base-T1 MDI Return Loss*. Users can use the VNA device or RIGOL's RSA3000N series equipped with the VNA mode to perform the MDI Mode Conversion Loss test. The following test schemes are available.

- **Vector Network Analyzer (VNA)**

Use a VNA device to perform the loss test. Then export the measurement data generated from the VNA device to the oscilloscope to perform the compliance analysis. Generate the analysis report.

- **Real-time spectrum analyzer with VNA mode**

RIGOL's RSA3000N series spectrum analyzer is recommended.

- **Online configuration:** Build network connection between the oscilloscope and the spectrum analyzer. Then control the spectrum analyzer to complete the calibration and measurement operation through the oscilloscope. After finishing the measurement, the oscilloscope reads the measurement data, makes an analysis, and generates the analysis report.
- **Offline import:** Use the VNA mode of the RSA3000N series spectrum analyzer to perform the loss test. Import the measurement data generated from the spectrum analyzer to the oscilloscope offline to perform the compliance analysis. Then generate the analysis report.

Offline Import

Please refer to *Offline Import* to perform the test and generate the analysis report.

Online Configuration

1. In the DS70000 operation interface, click or tap  > **AETH** to enter the "Automotive Ethernet Test" menu.
2. Click or tap to select **Open Alliance** as the specification, and **100Mbps** as the signal rate.
 - Click or tap to select **Two Single Signals** for the signal type.
 - In the "System Settings" tab, select "RSA" under **Device Select**. Then click or tap the input field of **IP Address**, then the interface is displayed, prompting you to

input the IP address of the RSA device with the pop-up numeric keypad. If successfully connected, **Connection Status** shows "Connected".

3. Click or tap **Test Item** > **100Base-T1(ECU) Tests** > **OABR_PMA_TX_06** > **MDI Mode Conversion Loss** to select the MDI Mode Conversion Loss test.
4. Refer to *S-Parameter Calibration* to complete the calibration.
5. Refer to *Loss Test* to complete the mode conversion loss test.

9.7 100Base-T1(ECU) MDI Common Mode Emission

For 100Base-T1 (ECU) MDI Common Mode Emission test, use the test fixture TF-AENET-MAT-STP (adaptor board) and the test fixture TF-AENET-MB-STP Section4 (breakout board) to perform the test. This section introduces the test by taking RIGOL DS70000 series oscilloscope as an example.

Select the Signal Type and Test Item

1. In the DS70000 operation interface, click or tap  > **AETH** to enter the "Automotive Ethernet Test" menu.
2. Click or tap **System Settings** to enter system setting menu.
 - Click or tap to select **Open Alliance** as the specification, and **100Mbps** as the signal rate.
 - Click or tap to select **Single Differential Signal** for the signal type.
3. Click or tap **Test Item** > **100Base-T1(ECU) Tests** > **OABR_PMA_TX_07** > **MDI Common Mode Emission** to select the MDI Common Mode Emission test.

Connect the Device

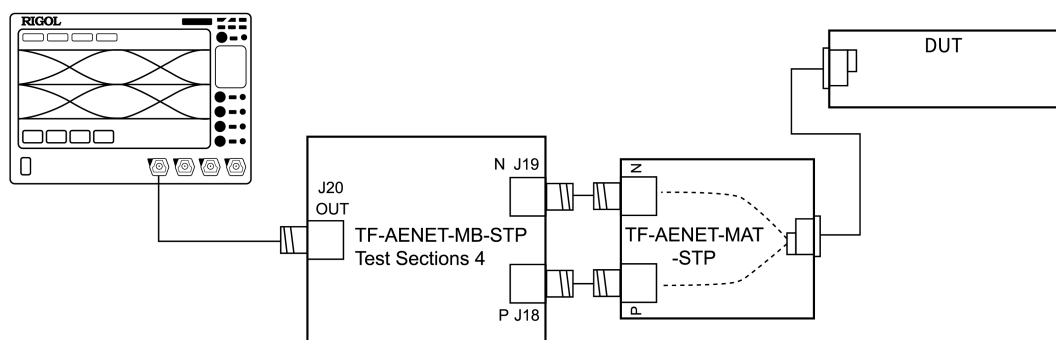

- Connect the DUT to the MDI interface of the fixture adaptor board by using the network cable.

- Connect Port P and Port N of the fixture TF-AENET-MB-STP Section4 to that of the fixture TF-AENET-MAT-STP by using the SMA adaptor.
- Connect Port J20 OUT of TF-AENET-MB-STP Section4 to the analog channel CH1 of the oscilloscope by using the BNC-to-SMA cable.

Test Procedures

1. Set the DUT as the master and set it to generate a Test Mode 5 signal.
2. Configure the DS70000 oscilloscope. Click or tap the function navigation icon and then select "AETH" to enter the "Automotive Ethernet Test" menu. In the **System Settings** tab, select the desired signal type. Then in the **Configuration** tab, select the specified channel source of the signal according to the actual device connection.
3. Click or tap **View Wfm** to preview the waveform for the specified test item in the waveform view to ensure that the waveform is properly output.
4. Click or tap **Test** to start testing. The "Compliance Analysis" dialog box is displayed. Wait for its analysis result.
5. After finishing the analysis, you can view the test results in the "100Base-T1 Results" window.

9.8 100Base-T1 (ECU) Transmitter Distortion

The distortion test can be performed in the following four test scenarios. The test schemes for different test scenarios are different.

- Without disturbing signal, without reference clock signal
- Without disturbing signal, with reference clock signal
- With disturbing signal, without reference clock signal
- With disturbing signal, with reference clock signal

Select the Signal Type and Test Item

1. In the DS70000 operation interface, click or tap  > **AETH** to enter the "Automotive Ethernet Test" menu.

2. Click or tap **System Settings** to enter system setting menu.
 - Click or tap to select **Open Alliance** as the specification, and **100Mbps** as the signal rate.
 - Click or tap to select **Two Single Signals** for the signal type.
3. Click or tap **Test Item** > **100Base-T1(ECU) Tests** > **OABR_PMA_TX_08(TM4)** > **Transmitter Distortion** to select the Transmitter Distortion test.

Transmitter Distortion (Without Disturbing Signal, Without Reference Clock)

1. In the DS70000 operation interface, click or tap the function navigation icon to select **AETH** to enter the "Automotive Ethernet Test" menu. In the **System Settings** tab, uncheck the checkbox of "Use Disturbing Signal" and uncheck the checkbox of "Use 10 MHz Ref Clock For Synchronization".
2. Refer to *Figure 7.2* to connect the oscilloscope, the fixture, and the DUT.
3. Refer to *Test Procedures* to complete the transmitter distortion test.

Transmitter Distortion (Without Disturbing Signal, With Reference Clock)

1. In the DS70000 operation interface, click or tap the function navigation icon to select **AETH** to enter the "Automotive Ethernet Test" menu. In the **System Settings** tab, uncheck the checkbox of "Use Disturbing Signal" and check the checkbox of "Use 10 MHz Ref Clock For Synchronization".
2. Refer to *Figure 7.9* to connect the oscilloscope, the fixture, and the DUT.
3. Refer to *Test Procedures* to complete the transmitter distortion test.

Transmitter Distortion (With Disturbing Signal, Without Reference Clock)

1. In the DS70000 operation interface, click or tap the function navigation icon to select **AETH** to enter the "Automotive Ethernet Test" menu. In the **System Settings** tab, check the checkbox of "Use Disturbing Signal" and uncheck the checkbox of "Use 10 MHz Ref Clock For Synchronization".
2. Refer to *To Calibrate the Disturbing Signal* to calibrate the disturbing signal.
Refer to *Fixture Calibration* to calibrate the fixture.
3. Refer to *Figure 7.8* to connect the oscilloscope, the fixture, and the DUT.

4. Refer to *Test Procedures* to complete the transmitter distortion test.

Transmitter Distortion (With Disturbing Signal, With Reference Clock)

1. In the DS70000 operation interface, click or tap the function navigation icon to select **AETH** to enter the "Automotive Ethernet Test" menu. In the **System Settings** tab, check the checkbox of "Use Disturbing Signal" and check the checkbox of "Use 10 MHz Ref Clock For Synchronization".
2. Refer to *To Calibrate the Disturbing Signal* to calibrate the disturbing signal. Refer to *Fixture Calibration* to calibrate the fixture.
3. Refer to *Figure 7.7* to connect the oscilloscope, the fixture, and the DUT.
4. Refer to *Test Procedures* to complete the transmitter distortion test.

10 Appendix

10.1 Appendix A: Order Information

Order Information	Order No.
DS70000 Option	
100M/1000M Automotive Ethernet Compliance Test	DS70000-AENETC
Kits and Fixtures	
Automotive Ethernet MATEnet Interface Fixtures and Kits: breakout board, adaptor SMA-MATEnet, and welding adaptor	TFB-AENET-MAT-STP
Automotive Ethernet H-MTD Interface Fixtures and Kits: breakout board, adaptor SMA-H-MTD, and welding adaptor	TFB-AENET-MTD-STP
Automotive Ethernet Breakout Board	TF-AENET-MB-STP
Automotive Ethernet Frequency Divider Board	TF-AENET-FDB-STP
Automotive Ethernet Preamplifier Board	TF-AENET-PAB-STP
Automotive Ethernet Matrix Switching Board	TF-AENET-MSB-STP
Recommended Accessories	
Automotive Ethernet Adaptor SMA-H-MTD	TF-AENET-MTD-STP
Automotive Ethernet Adaptor SMA-MATEnet	TF-AENET-MAT-STP
Automotive Ethernet Welding Adaptor	TF-AENET-PAD-STP
Low Pass Filter	TF-AENET-FB-STP
RF Cable SMA(M)-SMA(M)	CB-SMAM-SMAM-100-L-18G
VNA Calibration Kit	CK106A CK106E

For all the fixtures and recommended accessories, please contact the local office of RIGOL.

10.2 **Appendix B: Warranty**

RIGOL TECHNOLOGIES CO., LTD. (hereinafter referred to as RIGOL) warrants that the product mainframe and product accessories will be free from defects in materials and workmanship within the warranty period. If a product proves defective within the warranty period, RIGOL guarantees free replacement or repair for the defective product.

To get repair service, please contact your nearest RIGOL sales or service office.

There is no other warranty, expressed or implied, except such as is expressly set forth herein or other applicable warranty card. There is no implied warranty of merchantability or fitness for a particular purpose. Under no circumstances shall RIGOL be liable for any consequential, indirect, ensuing, or special damages for any breach of warranty in any case.

Boost Smart World and Technology Innovation

Industrial Intelligent
Manufacturing



Semiconductors



Education &
Research

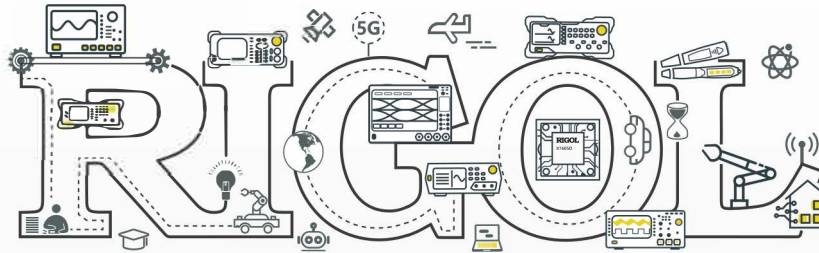

Communication

System Integration



New Energy



- 📶 Cellular-5G/WIFI
- 📍 UWB/RFID/ ZIGBEE
- 🔄 Digital Bus/Ethernet
- 📡 Optical Communication

- 🔧 Digital/Analog/RF Chip
- 📁 Memory and MCU Chip
- 🔌 Third-Generation Semiconductor
- ☀️ Solar Photovoltaic Cells

- 🚗 New Energy Automobile
- 🔋 PV/Inverter
- ⚡ Power Test
- 🔧 Automotive Electronics

*Provide Testing and Measuring Products
and Solutions for Industry Customers*

Distribution in the UK & Ireland



**Characterisation,
Measurement &
Analysis**

Lambda Photometrics Limited
Lambda House Batford Mill
Harpenden Herts AL5 5BZ
United Kingdom
E: info@lambdaphoto.co.uk
W: www.lambdaphoto.co.uk
T: +44 (0)1582 764334
F: +44 (0)1582 712084