

Distribution in the UK & Ireland



Lambda Photometrics Limited
Lambda House Batford Mill
Harpenden Herts AL5 5BZ
United Kingdom
E: info@lambdaphoto.co.uk
W: www.lambdaphoto.co.uk
T: +44 (0)1582 764334
F: +44 (0)1582 712084

DNA5000 Series

Vector Network Analyzer



Quick Guide
Nov. 2025

Guaranty and Declaration

Copyright

© 2025 RIGOL TECHNOLOGIES CO., LTD. All Rights Reserved.

Trademark Information

RIGOL® is the trademark of RIGOL TECHNOLOGIES CO., LTD.

Software Version

Software upgrade might change or add product features. Please acquire the latest software version from **RIGOL** website or contact **RIGOL** to upgrade the software.

Notices

- RIGOL products are covered by P.R.C. and foreign patents, issued and pending.
- RIGOL reserves the right to modify or change parts of or all the specifications and pricing policies at the company's sole decision.
- Information in this publication replaces all previously released materials.
- Information in this publication is subject to change without notice.
- RIGOL shall not be liable for either incidental or consequential losses in connection with the furnishing, use, or performance of this manual, as well as any information contained.
- Any part of this document is forbidden to be copied, photocopied, or rearranged without prior written approval of RIGOL.

Product Certification

RIGOL guarantees that this product conforms to the national and industrial standards in China as well as the ISO9001:2015 standard and the ISO14001:2015 standard. Other international standard conformance certifications are in progress.

Contact Us

If you have any problem or requirement when using our products or this manual, please contact RIGOL.

E-mail: service@rigol.com

Website: <http://www.rigol.com>

1 Document Overview

This document is intended to provide a quick overview of the front and rear panels, user interface and basic operation of the DNA5000 series vector network analyzer.



TIP

For the latest version of this manual, download it from the official website of RIGOL (<http://www.rigol.com>).

Publication Number

QGO01100-1110

Software Version

Software upgrade might change or add product features. Please acquire the latest version of the manual from RIGOL website or contact RIGOL to upgrade the software.

Format Conventions in this Manual

1. Key

The front panel key is denoted by the menu key icon. For example,  indicates the "System" key.

2. Menu

The menu item is denoted by the format of "Menu Name (Bold) + Character Shading" in the manual. For example, **Frequency** indicates clicking or tapping **Frequency** to enter the frequency setting menu.

3. Operation Procedures

The next step of the operation is denoted by ">" in the manual. For example, **Frequency** > **Center** indicates first clicking or tapping **Frequency**, and then clicking or tapping **Center**.

Content Conventions in this Manual

DNA5000 series vector network analyzer includes the following models. Unless otherwise specified, this manual takes DNA5262 as an example to illustrate the functions and operation methods of the DNA5000 series.

Model	Frequency	Number of Channels	Connector
DNA5042	5 kHz to 4.5 GHz	2	N-type Female
DNA5082	5 kHz to 8.5 GHz	2	N-type Female
DNA5142	5 kHz to 14 GHz	2	N-type Female

Model	Frequency	Number of Channels	Connector
DNA5202	5 kHz to 20 GHz	2	3.5mm Threaded Male Connector
DNA5262	5 kHz to 26.5 GHz	2	3.5mm Threaded Male Connector

2 Safety Requirement

2.1 General Safety Summary

Please review the following safety precautions carefully before putting the instrument into operation so as to avoid any personal injury or damage to the instrument and any product connected to it. To prevent potential hazards, please follow the instructions specified in this manual to use the instrument properly.

- | | | | |
|---|--|----|--|
| 1 | Only the exclusive power cord designed for the instrument and authorized for use within the destination country could be used. | 9 | Do not operate the instrument with suspected failures. |
| 2 | Ensure that the instrument is safely grounded. | 10 | Provide adequate ventilation. |
| 3 | Observe all terminal ratings. | 11 | Do not operate in wet conditions. |
| 4 | Use proper overvoltage protection. | 12 | Do not operate in an explosive atmosphere. |
| 5 | Do not operate without covers. | 13 | Keep instrument surfaces clean and dry. |
| 6 | Do not insert objects into the air outlet. | 14 | Prevent electrostatic impact. |
| 7 | Use the proper fuse. | 15 | Handle with caution. |
| 8 | Avoid circuit or wire exposure. | | |



WARNING

Equipment meeting Class A requirements may not offer adequate protection to broadcast services within residential environment.

2.2 Safety Notices and Symbols

Safety Notices in this Manual:



WARNING

Indicates a potentially hazardous situation or practice which, if not avoided, will result in serious injury or death.



CAUTION

Indicates a potentially hazardous situation or practice which, if not avoided, could result in damage to the product or loss of important data.

Safety Notices on the Product:

- **DANGER**

It calls attention to an operation, if not correctly performed, could result in injury or hazard immediately.

- **WARNING**

It calls attention to an operation, if not correctly performed, could result in potential injury or hazard.

- **CAUTION**

It calls attention to an operation, if not correctly performed, could result in damage to the product or other devices connected to the product.

Safety Symbols on the Product:

**Hazardous
Voltage**



Safety Warning



**Protective Earth
Terminal**

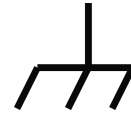

Chassis Ground



Test Ground

2.3 EMC Level

Class A (for non-residential products)

NOTE:

This equipment has been tested and found to comply with the limits for a Class A digital device, pursuant to Part 15 of the FCC Rules. These limits are designed to provide reasonable protection against harmful interference when the equipment is operated in a commercial environment. This equipment generates, uses, and can radiate radio frequency energy and, if not installed and used in accordance with the instruction manual, may cause harmful interference to radio communications. Operation of this equipment in a residential area is likely to cause harmful interference in which case the user will be required to correct the interference at his own expense.

2.4 Ventilation Requirement

This instrument uses a fan to force cooling. Please make sure that the air inlet and outlet areas are free from obstructions and have free air. When using the instrument in a bench-top or rack setting, provide at least 10 cm clearance beside, above and behind the instrument for adequate ventilation.

**CAUTION**

Inadequate ventilation may cause an increase of temperature in the instrument, which would cause damage to the instrument. So please keep the instrument well ventilated and inspect the air outlet and the fan regularly.

2.5 Working Environment

Temperature

Operating: 0°C to +40°C

Non-operating: -20°C to +70°C

Humidity

- **Operating:**

Below +30°C: ≤95% RH (without condensation)

+30°C to +40°C: ≤75% RH (without condensation)

+40°C to +50°C: ≤45% RH (without condensation)

- **Non-operating:**

Below +40°C: 5% to 90%, without condensation

+40°C to +60°C: 5% to 80%, without condensation

+60°C to +70°C: 5% to 40%, without condensation

**WARNING**

To avoid short circuit inside the instrument or electric shock, never operate the instrument in a humid environment.

Altitude

Operating altitude below 2,000 m (6,561.68 feet)

Protection Level Against Electric Shock

ESD ±8kV

Installation (Overvoltage) Category

This product is powered by mains conforming to installation (overvoltage) category II.

**WARNING**

Ensure that no overvoltage (such as that caused by a bolt of lightning) can reach the product. Otherwise, the operator might be exposed to the danger of an electric shock.

Installation (Overvoltage) Category Definitions

Installation (overvoltage) category I refers to signal level which is applicable to equipment measurement terminals connected to the source circuit. Among these terminals, precautions are done to limit the transient voltage to a low level.

Installation (overvoltage) category II refers to the local power distribution level which is applicable to equipment connected to the AC line (AC power).

Pollution Degree

Pollution Degree 2

Pollution Degree Definition

- **Pollution Degree 1:** No pollution or only dry, nonconductive pollution occurs. The pollution has no effect. For example, a clean room or air-conditioned office environment.
- **Pollution Degree 2:** Normally only nonconductive pollution occurs. Temporary conductivity caused by condensation is to be expected. For example, indoor environment.
- **Pollution Degree 3:** Conductive pollution or dry nonconductive pollution that becomes conductive due to condensation occurs. For example, sheltered outdoor environment.
- **Pollution Degree 4:** The pollution generates persistent conductivity caused by conductive dust, rain, or snow. For example, outdoor areas.

Safety Class

Class 1 – Grounded Product

2.6 Care and Cleaning

Care

Do not store or leave the instrument where it may be exposed to direct sunlight for long periods of time.

Cleaning

Clean the instrument regularly according to its operating conditions.

1. Disconnect the instrument from all power sources.
2. Clean the external surfaces of the instrument with a soft cloth dampened with mild detergent or water. Avoid having any water or other objects into the chassis via the heat dissipation hole. When cleaning the LCD, take care to avoid scarifying it.

CAUTION

To avoid damage to the instrument, do not expose it to caustic liquids.



**WARNING**

To avoid short-circuit resulting from moisture or personal injuries, ensure that the instrument is completely dry before connecting it to the power supply.

2.7 Environmental Considerations

The following symbol indicates that this product complies with the WEEE Directive 2012/19/EU.



The equipment may contain substances that could be harmful to the environment or human health. To avoid the release of such substances into the environment and avoid harm to human health, we recommend you to recycle this product appropriately to ensure that most materials are reused or recycled properly. Please contact your local authorities for disposal or recycling information.

You can click on the following link <https://www.rigol.com/intl/services/environmental-protection-statement.html> to download the latest version of the RoHS&WEEE certification file.

3 Product Overview

DNA5000 series vector network analyzer offers multiple calibration methods including frequency response, single port, response isolation, enhanced response, full two port, and electrical calibration. It supports various data display formats including log magnitude, linear magnitude, SWR (Standing Wave Ratio), phase, group delay, Smith chart, polar plot, etc. Equipped with standard USB, LAN, and HDMI interfaces, the instrument accurately measures the magnitude-frequency, phase-frequency, and group delay characteristics of microwave networks. This product can be widely applied in fields such as electronics, communication and microwave. It is a commonly used testing equipment in the research and production processes of industries and universities.

3.1 Appearance and Dimensions

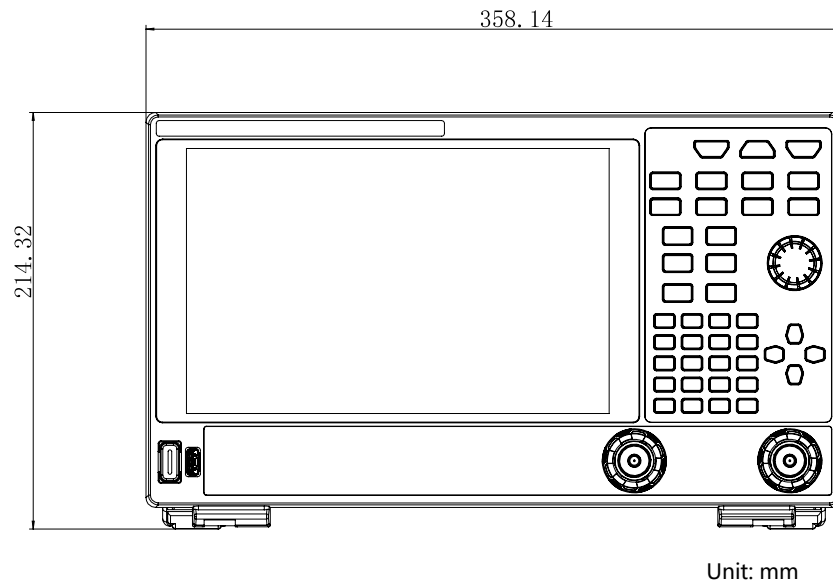

Figure 3.1 Front View of DNA5000

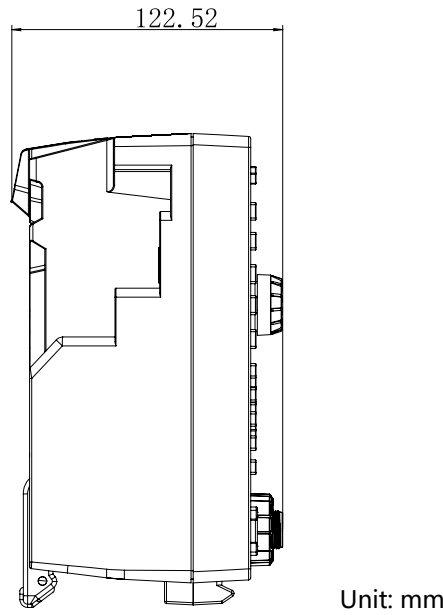

Figure 3.2 Side View of DNA5000

3.2 Front Panel

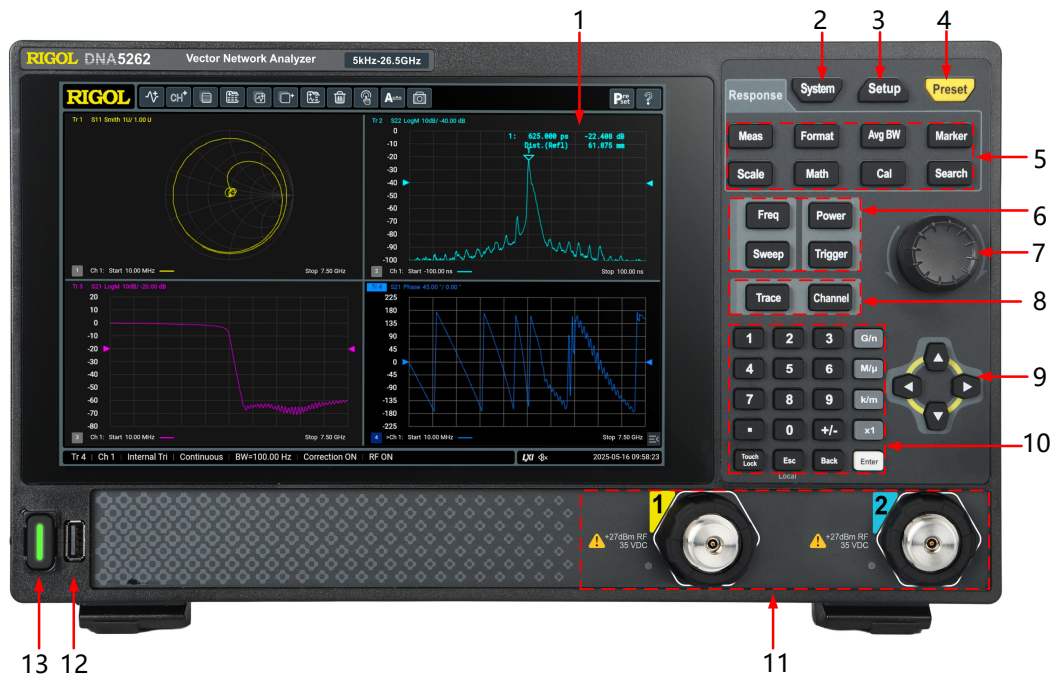

Figure 3.3 Front Panel of DNA5000 Series

1. Screen

10.1" capacitive gesture-enabled touch screen, with the display resolution 1280*800

2. System Key

Press this key to enter the system setting menu. You can set the IP address of the instrument, display or hide the system time, set the language, enable or disable the beeper, etc.

3. Setup Key

Press this key to enter the Setup menu.

4. Preset Key

Press this key to preset the system settings.

5. Response Function Keys

- **Meas:** sets the S-Parameter test of the port.
- **Format:** sets the data format of the measurement parameters.
- **Marker:** sets the marker of the measurement parameters, providing readout of S-Parameter measurement data.
- **Math:** performs math operation on the measurement data.
- **Scale:** sets the scale, reference level, and reference positions of the data trace on the screen.
- **Cal:** calibrates the port parameters under test for the device.
- **Search:** searches for the peak, max. value, min. value, target value of the test parameters.
- **Avg BW:** performs Averaging operation on the test data; sets the IF bandwidth of the receiver, etc.

6. Stimulus Function Keys

- **Freq:** sets the start frequency, center frequency, stop frequency, span, etc.
- **Power:** sets the power of output signal on the port.
- **Sweep:** sets the sweep points, sweep type, sweep time, etc.
- **Trigger:** sets the trigger source, trigger mode, trigger condition, etc.

7. Knob

When the parameter is editable, rotate the knob clockwise to increase or counterclockwise to decrease the parameter value at the specified step.

8. Trace/Channel Function Keys

- **Trace:** sets to add or delete traces.
- **Channel:** manages the channel, window, and sheet.

9. Arrow Keys

When the parameter is editable, use the arrow keys to increase or decrease the parameter value at the specific step. The steps for the Up/Down arrow keys and Left/Right arrow keys are different.

10. Numeric Keypad

- **0-9:** sets the measurement value, then press Enter or select the available units (G/n, M/ μ , k/m) to complete the input.
- **Decimal point:** inputs a decimal point.
- **+/-:** press this key to input the symbol ("+" or "-"). When you press the key for the first time, the parameter symbol "-" is displayed, and when you press it again, "+" is displayed.
- **Esc:** exists the current input state; or exists the remote control state.
- **Back:** press this key to delete the number on the left of the cursor.
- **Enter:** During parameter editing, pressing this key will complete the input and insert a default unit.
- **Touch Lock:** locks the touch screen of the instrument.
- **G/n, M/ μ , k/m:** specifies the measurement unit.
- **x1:** when inputting a unitless parameter, press this key to indicate no unit is added.

11. Test Ports

Indicate the input and output connectors of the test signal. The LED indicator at the left-lower corner of each test port indicates the output status of the signal source. It is illuminated when a signal is output from this connector.

12. USB HOST Interface

The analyzer can serve as a "master" device to connect to the external USB device. The USB storage device, mouse, and keypad board can be connected to the instrument via the interface.

13. Power Key

Powers on or off the instrument. When it is powered on, the power key indicator is constant on, illuminated in green.

3.3 Rear Panel

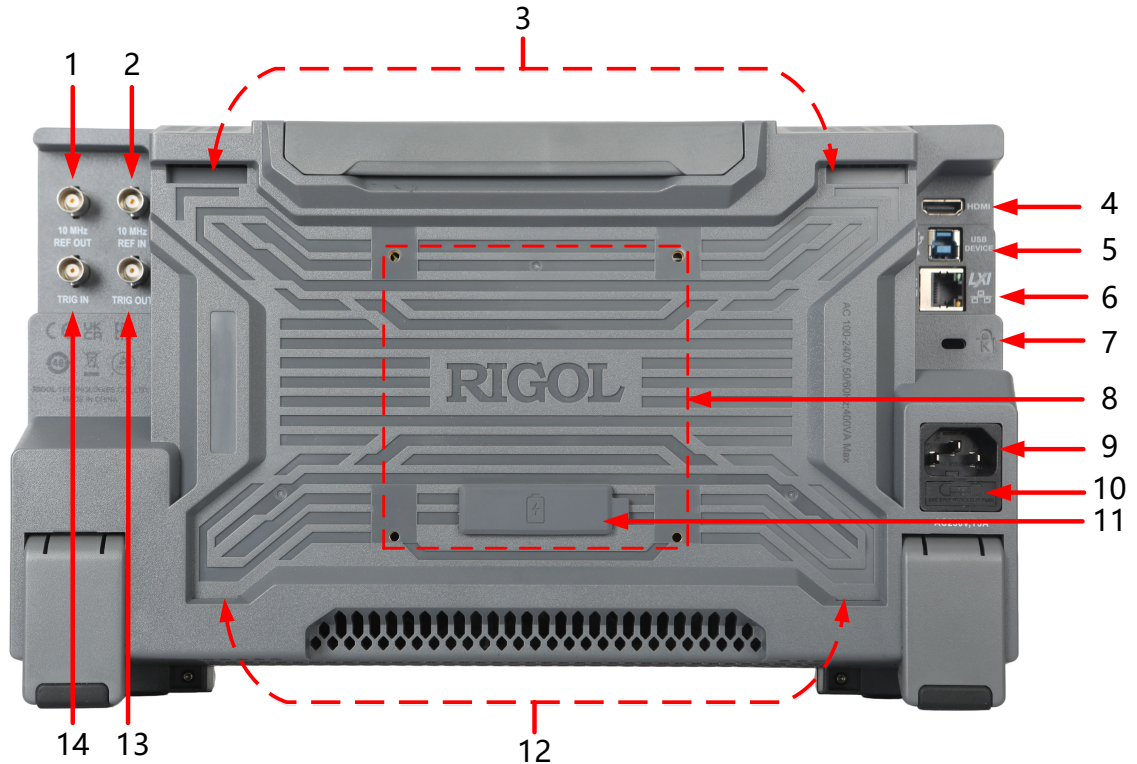

Figure 3.4 DNA5000 Series Rear Panel

1. 10 MHz REF OUT

BNC connector that can output the 10 MHz clock signal generated by the internal crystal oscillator inside the instrument.

2. 10 MHz REF IN

BNC connector to input external reference clock signal.

3. Battery Pack Snap-Fit Slot

Used to insert the battery pack snap-fit part to fasten the battery pack.

4. HDMI

Connects the instrument to an external display that has the HDMI interface (e.g. monitor or projector) via this interface to better observe the waveform display clearly. At this time, you can also view the waveforms on the LCD of the instrument.

5. USB DEVICE

Connects the instrument to the PC via this interface. Then you can use the PC software to send the SCPI commands or use the user-defined programming to control the instrument.

6. LAN

Connects the instrument to network via this interface. The instrument is in compliance with the standards specified in LXI CORE 2011 DEVICE, facilitating to set up a test system with other standard devices. Then you can control the instrument through using Web Control to send the SCPI commands.

7. Security Lock Hole

Use a standard PC/laptop lock cable to secure the instrument to a work bench or other location.

8. Screw Mounting Hole

Used for securing the instrument to the stand.

9. AC Power Socket

The AC power source supported by the instrument is 100-240 V, 50-60 Hz. Please use the power cord provided in the accessories to connect the instrument to the AC power source.

10. Fuse

If you need to replace the fuse, use the specified fuse.

11. Battery Pack Interface

Used to connect the battery pack.

12. Battery Pack Mounting Slot

Used to insert the battery pack snap-fit part to fasten the battery pack.

13. TRIG OUT

BNC connector to output external trigger signal.

14. TRIG IN

BNC connector to input external trigger signal to the instrument.

3.4 User Interface



No.	Description
1	Quick Operation Toolbar
2	Window Display Area
3	Function Menu Area
4	Notification Area
5	System Status Bar

3.4.1 Quick Operation Toolbar

The following figure shows the quick operation toolbar, and the table below it lists the functions of the quick operation keys on the toolbar at the top of the user interface.

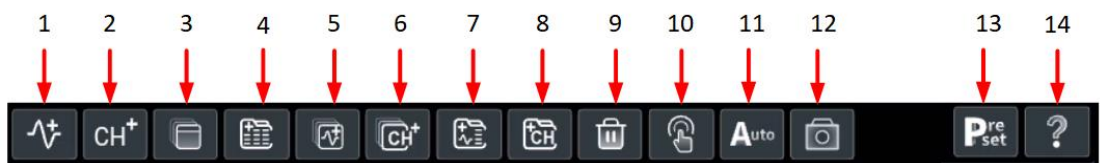

No.	Description
1	Adds a new trace.
2	Adds a new channel.
3	Adds a new window.
4	Adds a new sheet.
5	Adds a new trace to a new window.
6	Adds a new trace and channel to a new window.
7	Adds a new trace and channel to a new window in a new sheet.
8	Adds a new trace and a new channel to a new window in a sheet sheet.
9	Shortcut key for "Delete". By default, it deletes the Active Trace. If there is no Active Trace (i.e., an empty window), it deletes the Active Window. If the Sheet is empty, it deletes the Active Sheet, the last sheet cannot be deleted.
10	Manual trigger key.
11	Shortcut key for Auto Scale. Adjusts the parameters to the optimal state of the signal.
12	Saves the screenshot of the current screen.
13	Restores the system to preset settings. It functions the same as the front panel  key.
14	Displays the help document.

3.4.2 Window Display Area



No.	Description
1	Indicates sheet name. When there is only sheet, no sheet label is displayed. Click or tap the sheet tab to switch the sheet. You can also rename the sheet. Each sheet can contain multiple windows.
2	Indicates window. Traces can be displayed in the window. The definitions for the horizontal coordinate and vertical coordinate are related to the measurement parameter and data format. One sheet can display up to 9 windows. For the newly added windows, you can click or tap Pg Up or Pg Dn to view the desired window. <ul style="list-style-type: none"> • Single-clicking or tapping one window can make it become the active window. • Double-clicking or double-tapping the window area can maximize the currently selected window; double-clicking or double-tapping it again to restore to the multi-pane windowing. • Dragging the scale on the Y-axis can modify the reference level.
3	Indicates trace. It is a set of measurement data points. Clicking or tapping on the specified trace can select it as the active trace.
4	Indicates the trace number. Currently, it is not selected.

No.	Description
5	Indicates the trace number. Currently, it is selected.
6	Indicates the trace title. By default, it displays the test parameters.
7	Indicates the data format of the trace. In this figure, LogM indicates the log magnitude format.
8	Indicates Scale/Reference Level (related to the measurement data display format)
9	Indicates the stop frequency of the sweep.
10	Indicates the window number. Currently, the window is selected.
11	Indicates the trace for the channel. Its color is the same as the color of the trace for the specified channel.
12	Indicates the start frequency of the sweep.
13	Indicates the channel number.
14	Indicates the window number. Currently, the window is not selected.

3.4.3 Function Menu Area

Enter the Function Menu to make the settings.

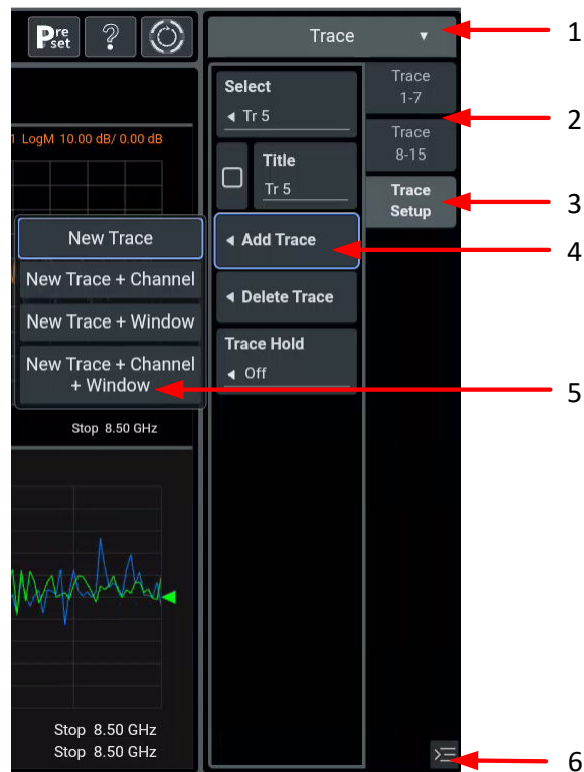

No.	Description
1	Function menu name. You can click or tap the drop-down button to switch to select other function menus.
2	Secondary sub-menu (unselected)
3	Secondary sub-menu (selected)
4	Third-level sub-menu. You can click or tap the drop-down button (<) to select the sub-menu under it.
5	Forth-level sub-menu
6	Shows/Hides the function menu

3.4.4 Notification Area

Displays LAN icon, sound icon, and remote control icon as well as date and time. You can click or tap this area to open the "System" menu.



No.	Description
1	Remote control icon. When you use Web Control to control the instrument remotely, Rmt will be displayed.
2	LAN icon. When the LAN interface is successfully connected, LXI is displayed.
3	Sound icon. Click or tap this icon to turn on or off the sound. When enabled, will be displayed ; when disabled, will be displayed.
4	Date: displays the system date. You can set it in the Setting sub-menu under System .
5	Time: displays the system time. You can set it in the Setting sub-menu under System .

3.4.5 System Status Bar

Displays the main parameters of the current system status.

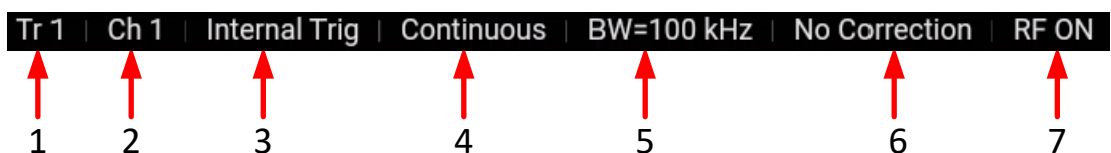

No.	Description
1	Active trace
2	Active channel
3	Trigger source. Currently it is set to internal trigger. It can be configured in the Trigger menu.
4	Trigger mode, currently set to continuous trigger. It can be configured in the Trigger menu.
5	IF bandwidth, which can be set in the Avg BW menu.
6	Calibration type. After calibration, it displays the calibration type. If correction is disabled, it displays No Correction.
7	Internal stimulus source. It displays the RF power status for all channels and can be configured in the Power menu.

4 To Prepare for Use

4.1 To Adjust the Supporting Legs

Adjust the supporting legs properly to use them as stands to tilt the oscilloscope upwards for stable placement of the oscilloscope to better operate and observe. You can fold the supporting legs for easier storage and shipment when the instrument is not in use. See the figure below.

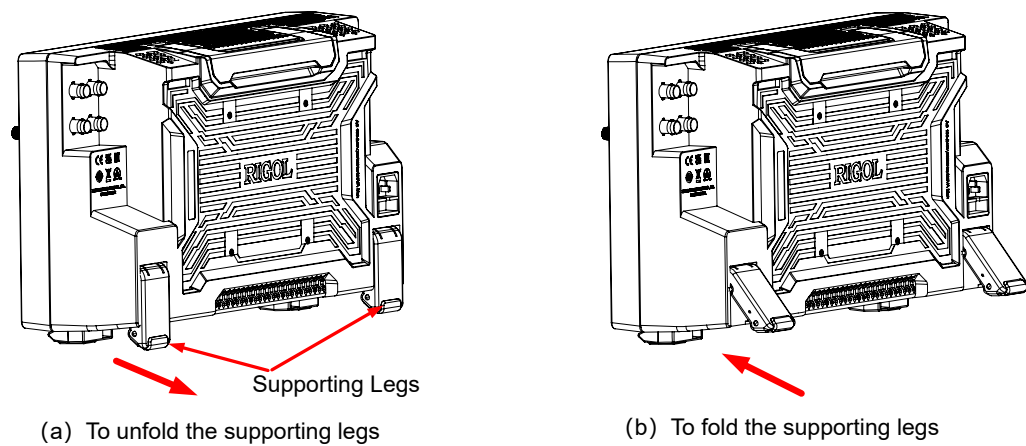
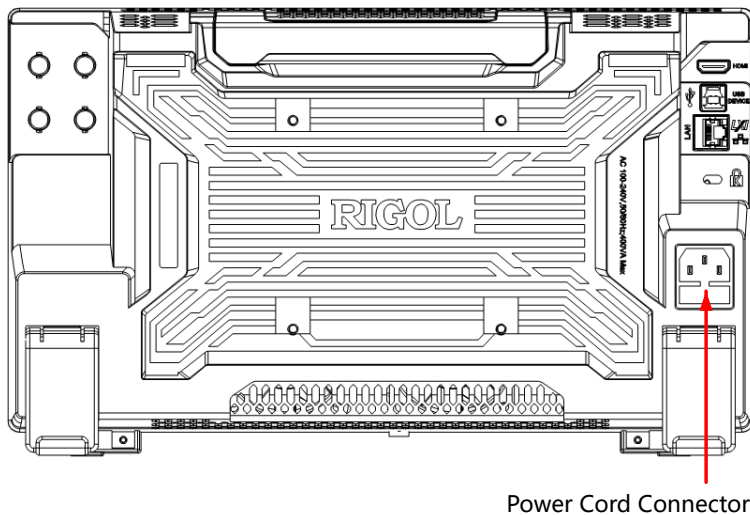

Figure 4.1 Adjust the Supporting Legs

4.2 To Connect to Power

Please use the power cord provided in the accessories to connect the spectrum analyzer to the AC power source. The AC power source supported by the instrument is 100-240 V, 50-60 Hz. The power consumption of the instrument cannot exceed 100W(400VA). When the spectrum analyzer is connected to the AC power source via the power cord, the instrument automatically adjusts itself to within the proper voltage range, and you do not need to select the voltage range manually.



Power Cord Connector

Figure 4.2 Connect to Power

**CAUTION**

To avoid electric shock, ensure that the instrument is correctly grounded.

4.3 To Replace the Fuse

If you need to replace the fuse, use only the specified fuse (AC 250 V, T5 A; 5.2 mm x 20 mm) and perform the following operations:

1. Turn off the instrument, cut off the power, and remove the power cord.
2. Use a small straight slotted screwdriver to pry out the fuse holder.
3. Take out the fuse holder.
4. Replace the old fuse with a specified fuse.
5. Install the fuse holder.

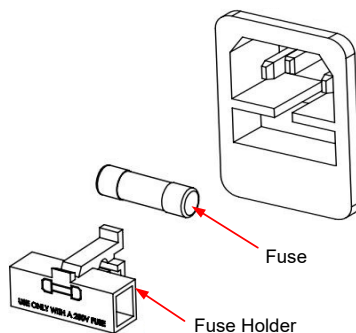





Figure 4.3 Replace the Fuse

**WARNING**

To avoid electric shock, please ensure that the instrument has been turned off, the power source has been cut off, and the fuse to be used conforms to the fuse rating.

4.4 Turn-on Checkout

- **Power on**
 - After connecting the instrument to the power source properly, press the power key  on the lower-left corner of the front panel to power on the instrument. During the start-up process, the instrument performs a series of self-tests. After the self-test, the splash screen is displayed.
 - Click or tap the Notification Area and select **Setting > Power Switch** in the displayed **System** menu. By default, the **Power Switch** menu is enabled. The instrument will be powered on automatically after the instrument is connected to power.
- **Shutdown**
 - Press the power key  and a prompt message "Are you sure to shutdown?" is displayed. Click or tap **OK** to shut down the instrument.
 - Press  twice to directly shut down the instrument.
 - Press  for three seconds to directly shut down the instrument.

4.5 To Set the System Language

This series supports multiple system languages. To select the desired language, click or tap the notification area at the lower-right corner of the screen to select **Setting > Language**.

5 Basic Operation

This chapter introduces the basic operation of the instrument.

5.1 Mouse/Keypad Board/Touch Screen Operation Rule

Mouse Operation Rule

Connect the mouse to the instrument via the USB HOST interface to perform the following operations. Note that you can only use the left mouse button to perform the left-click operation. Right-click and mouse rolling operation are not allowed.

1. Click the mouse to select the menu and window.
2. Long press the left mouse button to drag the displayed data or window.
3. In the Marker menu, click the mouse to move the marker, but you are unable to use the mouse to add a marker.

Keypad Board Operation Rule

After the keypad board is properly connected to the instrument via the USB HOST interface, and then you can use the shortcut keys on the keypad to perform the same function as what you do with the Function Key.

Touch Screen Operation Rule

The instrument has a 10.1" capacitive multi-touch screen, supporting many gesture-enabled touch operations.

- **Tap:** use one finger to tap the symbol or characters on the screen slightly.
 - Tap the menu and function key to make function settings.
 - Tap the input filed and the virtual keypad will pop up for parameter setting.
 - Tap the window and its tab bar to perform operations on the window.
- **Drag:** use one finger to select the object, and then drag the object to a destination place.
 - Drag the window or cursor to change the position of the window or cursor.
 - Drag the slider in the menu to change the function settings.
- **Pinch&Stretch:** pinch or stretch two points on the screen with two fingers to zoom in or out the waveform.

You can zoom in or out the scale of the horizontal coordinate (X-axis) and vertical coordinate (Y-axis) of the window.

5.2 Parameter Setting Method

The parameters can be set by using the front-panel numeric keypad, knob, arrow keys, touchscreen or external keypad and mouse. The parameter setting methods are as follows:

1. Numeric Keypad

When the input box is selected, make parameter setting via the numeric keypad on the front panel.

2. Knob

When the parameter is in editing mode, rotate the knob clockwise to increase or counterclockwise to decrease the parameter value at the specified step.

3. Arrow Keys

When the parameter is in editing mode, use the arrow keys to increase or decrease the parameter value at the specified step. Note that the step sizes for the Up/Down arrow key and the Left/Right arrow key are different.

4. Touchscreen

Use a finger to touch the screen and select the input box. Complete the parameter setting with the displayed virtual keypad with your finger.

5. External Keypad

When the input field is selected, make parameter setting via the external keypad.

6. External Mouse

Use the external mouse to select the input field. Complete the parameter setting with the displayed virtual keypad with the external mouse.

5.3 To Use the Built-in Help System

The built-in help document of the vector network analyzer provides information about the functions and menu introductions of the instrument.

Click or tap the help icon on the quick operation toolbar at the top of the main interface, then the Help documentation is displayed. You can get its help information by clicking on the link for the introduction of the specified function.

5.4 To View the Option and the Option Installation

This series vector network analyzer provides many options to meet various measurement requirements. If you need any of these options, order them according to the Order No. available in Data Sheet, and then install the options according to this

section. Besides, you can also view the options currently installed on the vector network analyzer and activate the newly purchased option.

1. View the Installed Option

If your instrument has currently installed the option, perform the following operations to view the name of the installed option and other detailed information about the option from the option list.

Click or tap the notification area in the lower-right corner of the screen to pop up the system menu. Click or tap **Options** to view the options currently installed.

2. Install the Option

The option license is a string with a fixed number of characters. Each instrument has one unique license. The license file should be in specific format, with the filename extension ".lic". After you purchase an option, you will obtain a key (used for obtaining the license). Then, you can install the option according to the following steps.

a. Obtain an option license

Log in to the RIGOL official website (<http://www.rigol.com>), click **SERVICE CENTER** > **LICENSE ACTIVATION** to enter the license activation interface.

Input the correct key, serial number (click or tap **About** to acquire the serial number of the instrument), and verification code. Click **Generate** to acquire the download link for the option license file.

b. Install the option

Install the option by sending SCPI commands. For details, refer to *Programming Guide* of the product. After installation, a prompt message "Option activated successfully" is displayed. After the option has been installed, you are recommended to restart the instrument.



TIP

- During the installation process, you are not allowed to power off the instrument.
- Installing options by sending SCPI commands is supported. Installing options by inputting the license code manually is not supported.

5.5 Remote Control

This instrument supports Web Control remote operation. Web Control is Web-based remote control operation. With Web control, you can access and operate the LAN-connected instrument via the web page on any smart terminals such as PC, mobile, and iPad, without needing to install any software. The operation procedures are as follows:

1. Connect the instrument to the network

Ensure that the rear-panel LAN interface is connected to the network. Note that the instrument must be connected to the network where the control terminal is located. Then you can operate the instrument in remote way by accessing the network.

2. Obtain the IP address

In the **System** menu, click or tap **IO** to view the IP address of the instrument.

3. Input the IP address of the instrument into the browser address bar, then press Enter to access the web page, as shown in the following figure.

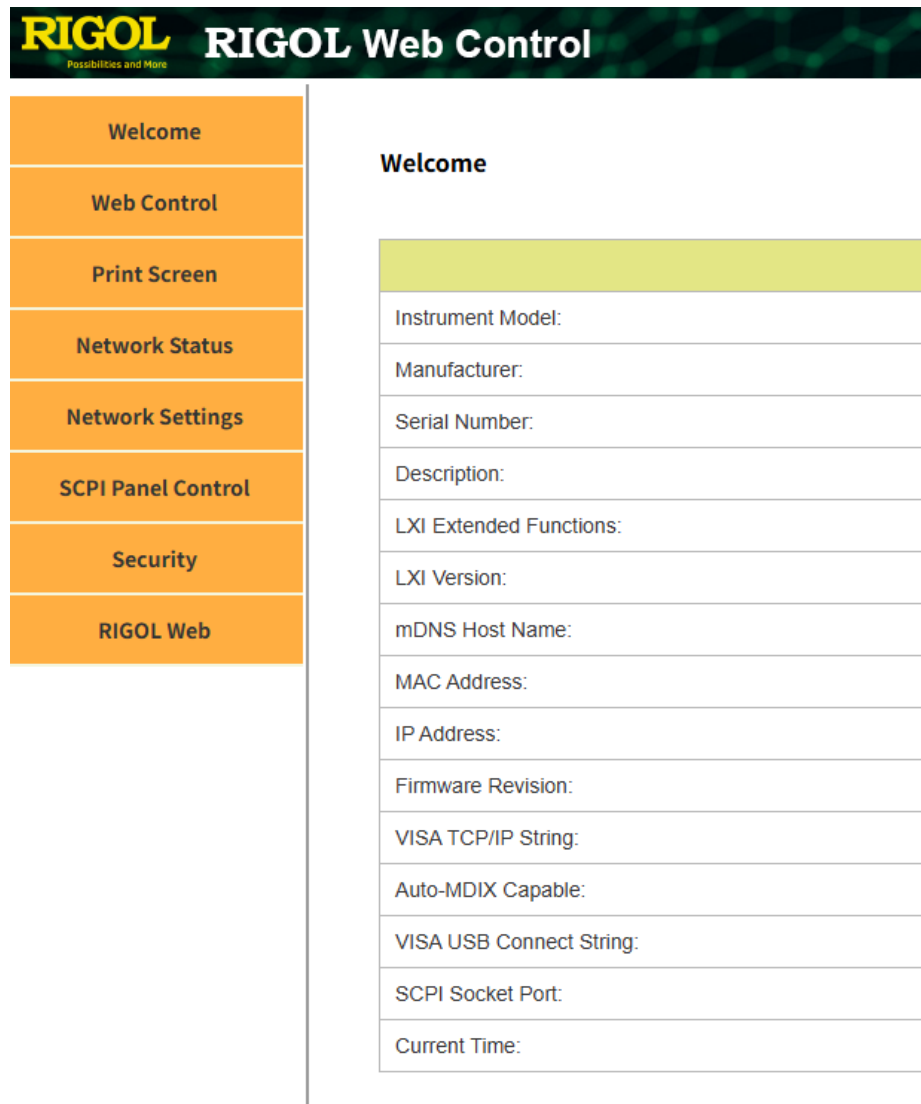

4. Click **Web Control** on the left side of the screen to enter the instrument remote control interface. You can use the mouse to remotely control the instrument in real time, with the same effect as operating the instrument directly.

5. Click **Print Screen**, and you can select "Take Screenshot" or "Record Screen" to capture the current screen shot.

6. Click **Network Settings** to configure the network. Note that login is required when changing the network configuration. When you first log in to the Web Control, use the user name "admin" and the password "rigol"..
7. The SCPI Panel Control function allows the user to send SCPI commands through the web interface for remote programming control of the instrument. Click **SCPI Panel Control** to enter the commands into the SCPI Command input field. After inputting the commands, click the **Send&Read** button to send the command and read the returned value.

You can program and control the instrument by using the SCPI (Standard Commands for Programmable Instruments) commands. For details about the SCPI commands and programming, refer to *Programming Guide* of this series of product.

8. Close the browser to exit the instrument remote control interface.

Only one user can access the instrument IP address for remote control operation at a time. First come, first served. Concurrent logins are not allowed. If the connection is interrupted, you can refresh the browser to load the page.



CAUTION

Before setting up communication, please turn off the instrument to avoid causing damage to the communication interfaces.

Boost Smart World and Technology Innovation

Industrial Intelligent
Manufacturing



Semiconductors

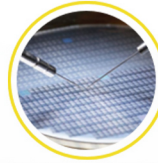

Education &
Research

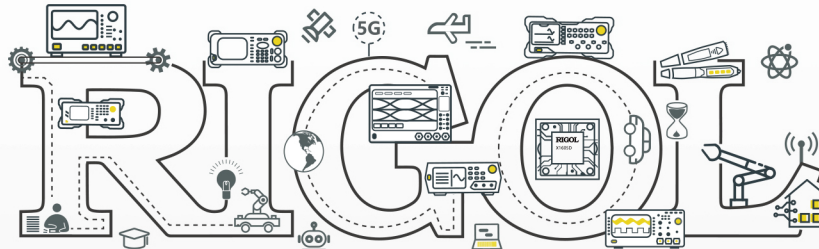

Communication

System Integration

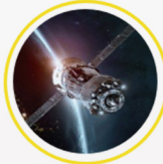

New Energy



- Cellular-5G/WIFI
- UWB/RFID/ ZIGBEE
- Digital Bus/Ethernet
- Optical Communication

- Digital/Analog/RF Chip
- Memory and MCU Chip
- Third-Generation Semiconductor
- Solar Photovoltaic Cells

- New Energy Automobile
- PV/Inverter
- Power Test
- Automotive Electronics

*Provide Testing and Measuring Products
and Solutions for Industry Customers*

HEADQUARTER

RIGOL TECHNOLOGIES CO., LTD.
No.8 Keling Road, New District,
Suzhou, JiangSu, P.R.China
Tel: +86-400620002
Email: info-cn@rigol.com

JAPAN

RIGOL JAPAN CO., LTD.
5F, 3-45-6, Minamiotsuka, Toshima-Ku,
Tokyo, 170-0005, Japan
Tel: +81-3-6262-8932
Fax: +81-3-6262-8933
Email: info.jp@rigol.com

EUROPE

RIGOL TECHNOLOGIES EU GmbH
Friedrichshafener Str. 5
82205 Gilching
Germany
Tel: +49(0)8105-27292-21
Email: info-europe@rigol.com

KOREA

RIGOL KOREA CO., LTD.
5F, 222, Gonghang-daero,
Gangseo-gu, Seoul, Republic of Korea
Tel: +82-2-6953-4466
Fax: +82-2-6953-4422
Email: info.kr@rigol.com

NORTH AMERICA

RIGOL TECHNOLOGIES, USA INC.
10220 SW Nimbus Ave.
Suite K-7
Portland, OR 97223
Tel: +1-877-4-RIGOL-1
Email: sales@rigol.com

For Assistance in Other Countries

Email: info.int@rigol.com

RIGOL® is the trademark of **RIGOL TECHNOLOGIES CO., LTD.** Product information in this document is subject to update without notice. For the latest information about **RIGOL's** products, applications and services, please contact local **RIGOL** channel partners or access **RIGOL** official website: www.rigol.com