

Distribution in the UK & Ireland



Lambda Photometrics Limited
Lambda House Batford Mill
Harpenden Herts AL5 5BZ
United Kingdom
E: info@lambdaphoto.co.uk
W: www.lambdaphoto.co.uk
T: +44 (0)1582 764334
F: +44 (0)1582 712084

DNA6000 Series

Vector Network Analyzer

User Guide

Jan.2026



Guaranty and Declaration

Copyright

© 2026 RIGOL TECHNOLOGIES CO., LTD. All Rights Reserved.

Trademark Information

RIGOL® is the trademark of RIGOL TECHNOLOGIES CO., LTD.

Notices

- RIGOL products are covered by P.R.C. and foreign patents, issued and pending.
- RIGOL reserves the right to modify or change parts of or all the specifications and pricing policies at the company's sole decision.
- Information in this publication replaces all previously released materials.
- Information in this publication is subject to change without notice.
- RIGOL shall not be liable for either incidental or consequential losses in connection with the furnishing, use, or performance of this manual, as well as any information contained.
- Any part of this document is forbidden to be copied, photocopied, or rearranged without prior written approval of RIGOL.

Product Certification

RIGOL guarantees that this product conforms to the national and industrial standards in China as well as the ISO9001:2015 standard and the ISO14001:2015 standard. Other international standard conformance certifications are in progress.

Contact Us

If you have any problem or requirement when using our products or this manual, please contact RIGOL.

E-mail: service@rigol.com

Website: <http://www.rigol.com>

1 Document Overview

This document is intended to provide a quick overview of the front and rear panels, user interface and basic operation of the DNA6000 series vector network analyzer.



TIP

For the latest version of this manual, download it from the official website of RIGOL (<http://www.rigol.com>).

Publication Number

UGR02101-1110

Software Version

00.00.11

Software upgrade might change or add product features. Please acquire the latest version of the manual from RIGOL website or contact RIGOL to upgrade the software.

Format Conventions in this Manual

1. Key

The front panel key is denoted by the menu key icon. For example,  indicates the "System" key.

2. Menu

The menu item is denoted by the format of "Menu Name (Bold) + Character Shading" in the manual. For example, **Frequency** indicates clicking or tapping **Frequency** to enter the frequency setting menu.

3. Operation Procedures

The next step of the operation is denoted by ">" in the manual. For example, **Frequency** > **Center** indicates first clicking or tapping **Frequency**, and then clicking or tapping **Center**.

Content Conventions in this Manual

DNA6000 series vector network analyzer includes the following models. Unless otherwise specified, this manual takes DNA6264 as an example to illustrate the functions and operation methods of the DNA6000 series.

Model	Frequency	Number of Channels	Connector
DNA6082	5 kHz to 8.5 GHz	2	N-type Female
DNA6084	5 kHz to 8.5 GHz	4	N-type Female

Model	Frequency	Number of Channels	Connector
DNA6142	5 kHz to 14 GHz	2	N-type Female
DNA6144	5 kHz to 14 GHz	4	N-type Female
DNA6202	5 kHz to 20 GHz	2	3.5mm Threaded Male Connector
DNA6204	5 kHz to 20 GHz	4	3.5mm Threaded Male Connector
DNA6262	5 kHz to 26.5 GHz	2	3.5mm Threaded Male Connector
DNA6264	5 kHz to 26.5 GHz	4	3.5mm Threaded Male Connector

2 Safety Requirement

2.1 General Safety Summary

Please review the following safety precautions carefully before putting the instrument into operation so as to avoid any personal injury or damage to the instrument and any product connected to it. To prevent potential hazards, please follow the instructions specified in this manual to use the instrument properly.

- **Use Proper Power Cord.**

Only the exclusive power cord designed for the instrument and authorized for use within the local country could be used.

- **Ground the Instrument.**

The instrument is grounded through the Protective Earth lead of the power cord. To avoid electric shock, it is essential to connect the earth terminal of the power cord to the Protective Earth terminal before connecting any inputs or outputs.

- **Observe All Terminal Ratings.**

To avoid fire or shock hazard, observe all ratings and markers on the instrument and check your manual for more information about ratings before connecting the instrument.

- **Use Proper Overvoltage Protection.**

Ensure that no overvoltage (such as that caused by a bolt of lightning) can reach the product. Otherwise, the operator might be exposed to the danger of an electric shock.

- **Do Not Operate Without Covers.**

Do not operate the instrument with covers or panels removed.

- **Do Not Insert Objects Into the Air Outlet.**

Do not insert anything into the holes of the fan to avoid damaging the instrument.

- **Use Proper Fuse.**

Please use the specified fuses.

- **Avoid Circuit or Wire Exposure.**

Do not touch exposed junctions and components when the unit is powered on.

- **Do Not Operate With Suspected Failures.**

If you suspect damage occurs to the instrument, have it inspected by RIGOL authorized personnel before further operations. Any maintenance, adjustment or

replacement especially to circuits or accessories must be performed by RIGOL authorized personnel.

- **Provide Adequate Ventilation.**

Inadequate ventilation may cause an increase of temperature in the instrument, which would cause damage to the instrument. So please keep the instrument well ventilated and inspect the air outlet and the fan regularly.

- **Do Not Operate in Wet Conditions.**

To avoid short circuit inside the instrument or electric shock, never operate the instrument in a humid environment.

- **Do Not Operate in an Explosive Atmosphere.**

To avoid personal injuries or damage to the instrument, never operate the instrument in an explosive atmosphere.

- **Keep Instrument Surfaces Clean and Dry.**

To avoid dust or moisture from affecting the performance of the instrument, keep the surfaces of the instrument clean and dry.

- **Prevent Electrostatic Impact.**

Operate the instrument in an electrostatic discharge protective environment to avoid damage induced by static discharges. Always ground both the internal and external conductors of cables to release static before making connections.

- **Use the Battery Properly.**

Do not expose the battery (if available) to high temperature or fire. Keep it out of the reach of children. Improper change of a battery (lithium battery) may cause an explosion. Use the RIGOL specified battery only.

- **Handle with Caution.**

Please handle with care during transportation to avoid damage to keys, knobs, interfaces, and other parts on the panels.



WARNING

Equipment meeting Class A requirements may not offer adequate protection to broadcast services within residential environment.

2.2 Safety Notices and Symbols

Safety Notices in this Manual:



WARNING

Indicates a potentially hazardous situation or practice which, if not avoided, will result in serious injury or death.



CAUTION

Indicates a potentially hazardous situation or practice which, if not avoided, could result in damage to the product or loss of important data.

Safety Notices on the Product:

- **DANGER**

It calls attention to an operation, if not correctly performed, could result in injury or hazard immediately.

- **WARNING**

It calls attention to an operation, if not correctly performed, could result in potential injury or hazard.

- **CAUTION**

It calls attention to an operation, if not correctly performed, could result in damage to the product or other devices connected to the product.

Safety Symbols on the Product:



Hazardous
Voltage



Safety Warning



Protective Earth
Terminal

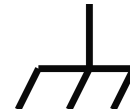

Chassis Ground

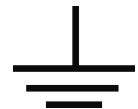

Test Ground

2.3 EMC Level

Class A (for non-residential products)

NOTE:

This equipment has been tested and found to comply with the limits for a Class A digital device, pursuant to Part 15 of the FCC Rules. These limits are designed to provide reasonable protection against harmful interference when the equipment is operated in a commercial environment. This equipment generates, uses, and can radiate radio frequency energy and, if not installed and used in accordance with the instruction manual, may cause harmful interference to radio communications.

Operation of this equipment in a residential area is likely to cause harmful interference in which case the user will be required to correct the interference at his own expense.

2.4 Ventilation Requirement

This instrument uses a fan to force cooling. Please make sure that the air inlet and outlet areas are free from obstructions and have free air. When using the instrument

in a bench-top or rack setting, provide at least 10 cm clearance beside, above and behind the instrument for adequate ventilation.

**CAUTION**

Inadequate ventilation may cause an increase of temperature in the instrument, which would cause damage to the instrument. So please keep the instrument well ventilated and inspect the air outlet and the fan regularly.

2.5 Working Environment

Temperature

Operating: 0°C to +40°C

Non-operating: -20°C to +70°C

Humidity

- **Operating:**

Below +30°C: ≤95% RH (without condensation)

+30°C to +40°C: ≤75% RH (without condensation)

- **Non-operating:**

Below +40°C: 5% to 90%, without condensation

+40°C to +60°C: 5% to 80%, without condensation

+60°C to +70°C: 5% to 40%, without condensation

**WARNING**

To avoid short circuit inside the instrument or electric shock, never operate the instrument in a humid environment.

Altitude

Operating altitude below 2,000 m (6,561.68 feet)

Protection Level Against Electric Shock

ESD ±8kV

Installation (Overvoltage) Category

This product is powered by mains conforming to installation (overvoltage) category II.

**WARNING**

Ensure that no overvoltage (such as that caused by a bolt of lightning) can reach the product. Otherwise, the operator might be exposed to the danger of an electric shock.

Installation (Overvoltage) Category Definitions

Installation (overvoltage) category I refers to signal level which is applicable to equipment measurement terminals connected to the source circuit. Among these terminals, precautions are done to limit the transient voltage to a low level.

Installation (overvoltage) category II refers to the local power distribution level which is applicable to equipment connected to the AC line (AC power).

Pollution Degree

Pollution Degree 2

Pollution Degree Definition

- **Pollution Degree 1:** No pollution or only dry, nonconductive pollution occurs. The pollution has no effect. For example, a clean room or air-conditioned office environment.
- **Pollution Degree 2:** Normally only nonconductive pollution occurs. Temporary conductivity caused by condensation is to be expected. For example, indoor environment.
- **Pollution Degree 3:** Conductive pollution or dry nonconductive pollution that becomes conductive due to condensation occurs. For example, sheltered outdoor environment.
- **Pollution Degree 4:** The pollution generates persistent conductivity caused by conductive dust, rain, or snow. For example, outdoor areas.

Safety Class

Class 1 – Grounded Product

2.6 Care and Cleaning

Care

Do not store or leave the instrument where it may be exposed to direct sunlight for long periods of time.

Cleaning

Clean the instrument regularly according to its operating conditions.

1. Disconnect the instrument from all power sources.
2. Clean the external surfaces of the instrument with a soft cloth dampened with mild detergent or water. Avoid having any water or other objects into the chassis via the heat dissipation hole. When cleaning the LCD, take care to avoid scarifying it.

CAUTION

To avoid damage to the instrument, do not expose it to caustic liquids.



**WARNING**

To avoid short-circuit resulting from moisture or personal injuries, ensure that the instrument is completely dry before connecting it to the power supply.

2.7 Environmental Considerations

The following symbol indicates that this product complies with the WEEE Directive 2012/19/EU.



The equipment may contain substances that could be harmful to the environment or human health. To avoid the release of such substances into the environment and avoid harm to human health, we recommend you to recycle this product appropriately to ensure that most materials are reused or recycled properly. Please contact your local authorities for disposal or recycling information.

You can click on the following link <https://www.rigol.com/intl/services/environmental-protection-statement.html> to download the latest version of the RoHS&WEEE certification file.

3 Product Features

Product Features

- Frequency range: 5 kHz to 26.5 GHz
- Models with 2 or 4 ports are available for different test scenarios
- Frequency resolution 1 Hz
- Max. output power 10 dBm
- High dynamic range 127 dB (typ.)
- Trace noise: 0.003 dB
- IF BW: 1 Hz to 10 MHz
- Compatible with the mechanical calibration kit and the Ecal electronic calibration kit, supporting various calibration types (SOLT, Response Short, Response Open, OSL, Enhanced Response 1 to 2, Response Through)
- Integrates S-parameters, impedance, VSWR, TDA, fixture embedding/de-embedding, antenna test, and etc.
- Compact size: 358.1 mm x 214.8 mm x 300 mm
- 10.1" 1280x800 HD touch screen
- Supports LAN, USB Device, USB Host, HDMI, GPIB, and Application I/O interfaces
- Supports standard SCPI instruction sets
- Supports Web Control for remote operation
- Supports both physical key operation and touch screen operation; allowing you to use externally connected keyboard and mouse to input values

DNA6000 series vector network analyzer provides various calibration methods such as frequency response, single-port, response isolation, enhanced response, full dual-port, and electronic calibration. It supports various display formats such as Log Mag, Lin Mag, SWR, Phase, Group Delay, Smith Chart, and Polar Chart. Through the connectivity with the instrument under test via the standard interfaces such as USB, LAN, and HDMI, this series can accurately measure the amp/freq characteristics, phase/freq characteristics, and group delay characteristics of the microwave network.

While maintaining the high-performance characteristics in terms of its specifications, appearance, display effects, and software interface, the DNA6000 series features compact size, light weight, and low noise, offering you better user experience. This series product can be widely used in the electronics, communication, and microwave fields. It is the commonly used test instrument in the R&D and batch production for the industry and universities.

4 Quick Start

4.1 General Inspection

1. Inspect the packaging

If the packaging has been damaged, do not dispose the damaged packaging or cushioning materials until the shipment has been checked for completeness and has passed both electrical and mechanical tests.

The consigner or carrier shall be liable for the damage to the instrument resulting from shipment. RIGOL would not be responsible for free maintenance/rework or replacement of the instrument.

2. Inspect the instrument

In case of any mechanical damage, missing parts, or failure in passing the electrical and mechanical tests, contact your RIGOL sales representative.

3. Check the accessories

Please check the accessories according to the packing lists. If the accessories are damaged or incomplete, please contact your RIGOL sales representative.

Recommended Calibration Interval

RIGOL suggests that the instrument should be calibrated every 18 months.

4.2 Product Overview

DNA6000 series vector network analyzer offers multiple calibration methods including frequency response, single port, response isolation, enhanced response, full two port, and electrical calibration. It supports various data display formats including log magnitude, linear magnitude, SWR (Standing Wave Ratio), phase, group delay, Smith chart, polar plot, etc. Equipped with standard USB, LAN, and HDMI interfaces, the instrument accurately measures the magnitude-frequency, phase-frequency, and group delay characteristics of microwave networks. This product can be widely applied in fields such as electronics, communication and microwave. It is a commonly used testing equipment in the research and production processes of industries and universities.

4.2.1 Appearance and Dimensions

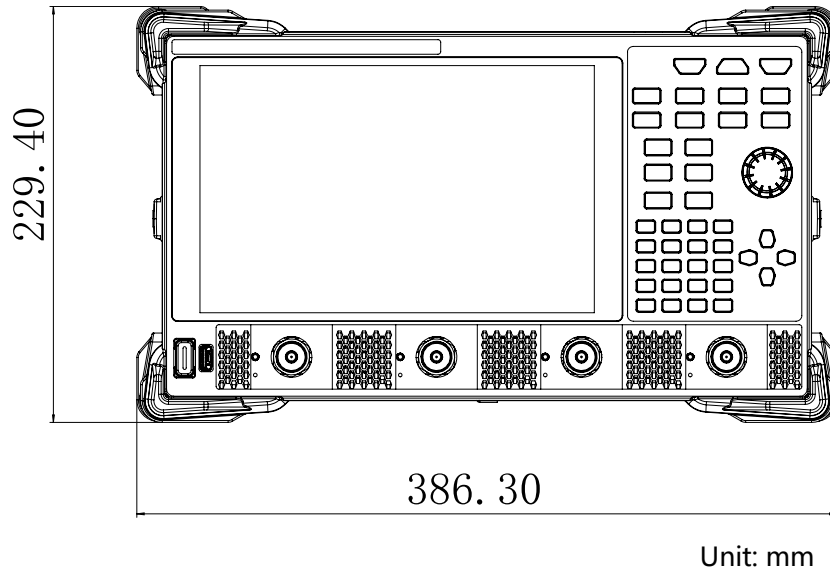

Figure 4.1 Front View of DNA6000

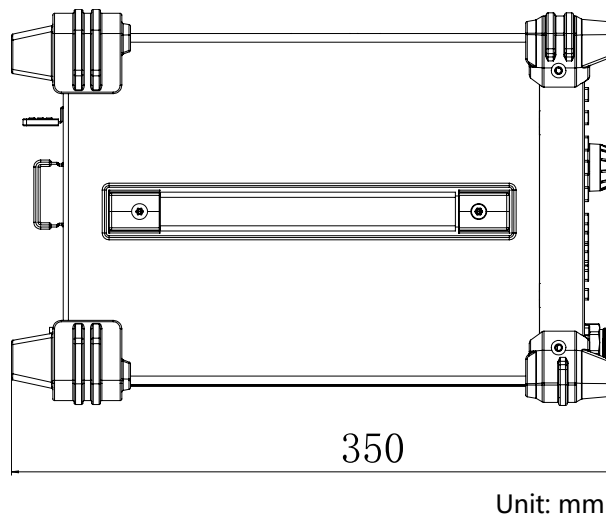

Figure 4.2 Side View of DNA6000

4.2.2 Front Panel

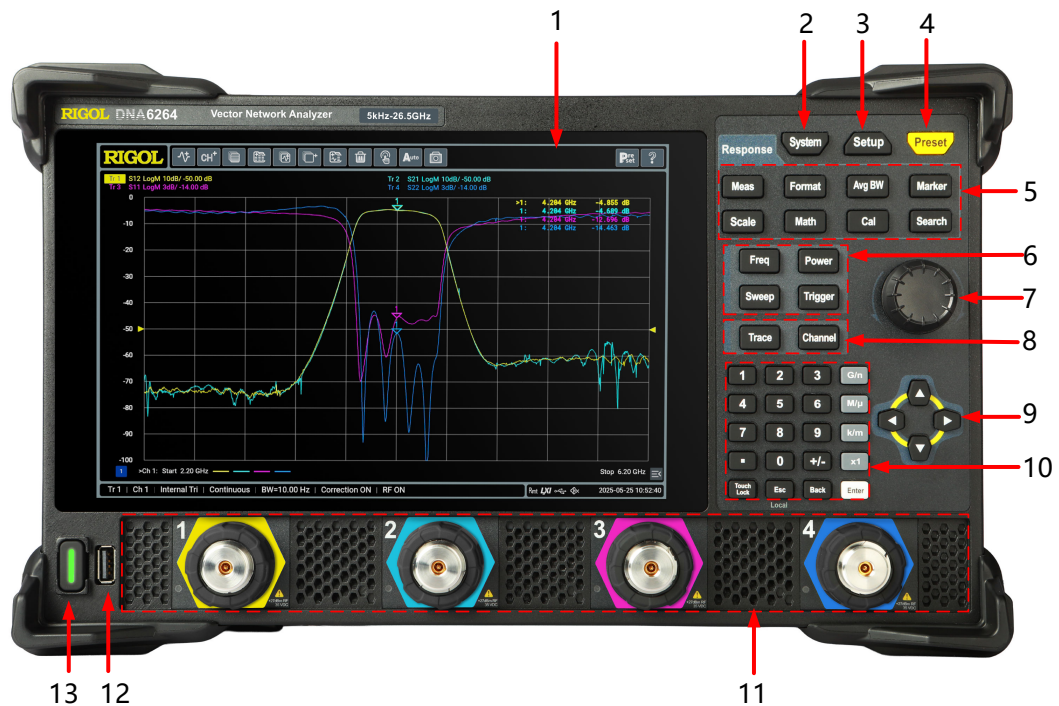

Figure 4.3 Front Panel of DNA6000 Series

1. Screen

10.1" capacitive gesture-enabled touch screen, with the display resolution 1280*800

2. System Key

Press this key to enter the system setting menu. You can set the IP address of the instrument, display or hide the system time, set the language, enable or disable the beeper, etc.

3. Setup Key

Press this key to enter the Setup menu.

4. Preset Key

Press this key to preset the system settings.

5. Response Function Keys

- **Meas:** sets the S-Parameter test of the port.
- **Format:** sets the data format of the measurement parameters.

- **Marker:** sets the marker of the measurement parameters, providing readout of S-Parameter measurement data.
- **Math:** performs math operation on the measurement data.
- **Scale:** sets the scale, reference level, and reference positions of the data trace on the screen.
- **Cal:** calibrates the port parameters under test for the device.
- **Search:** searches for the peak, max. value, min. value, target value of the test parameters.
- **Avg BW:** performs Averaging operation on the test data; sets the IF bandwidth of the receiver, etc.

6. Stimulus Function Keys

- **Freq:** sets the start frequency, center frequency, stop frequency, span, etc.
- **Power:** sets the power of output signal on the port.
- **Sweep:** sets the sweep points, sweep type, sweep time, etc.
- **Trigger:** sets the trigger source, trigger mode, trigger condition, etc.

7. Knob

When the parameter is editable, rotate the knob clockwise to increase or counterclockwise to decrease the parameter value at the specified step.

8. Trace/Channel Function Keys

- **Trace:** sets to add or delete traces.
- **Channel:** manages the channel, window, and sheet.

9. Arrow Keys

When the parameter is editable, use the arrow keys to increase or decrease the parameter value at the specific step. The steps for the Up/Down arrow keys and Left/Right arrow keys are different.

10. Numeric Keypad

- **0-9:** sets the measurement value, then press Enter or select the available units (G/n, M/ μ , k/m) to complete the input.
- **Decimal point:** inputs a decimal point.

- **+/-**: press this key to input the symbol ("+" or "-"). When you press the key for the first time, the parameter symbol "-" is displayed, and when you press it again, "+" is displayed.
- **Esc**: exists the current input state; or exists the remote control state.
- **Back**: press this key to delete the number on the left of the cursor.
- **Enter**: During parameter editing, pressing this key will complete the input and insert a default unit.
- **Touch Lock**: locks the touch screen of the instrument.
- **G/n, M/ μ , k/m**: specifies the measurement unit.
- **x1**: when inputting a unitless parameter, press this key to indicate no unit is added.

11. Test Ports

Indicate the input and output connectors of the test signal. The LED indicator at the left-lower corner of each test port indicates the output status of the signal source. It is illuminated when a signal is output from this connector.

12. USB HOST Interface

The analyzer can serve as a "master" device to connect to the external USB device. The USB storage device, mouse, and keypad board can be connected to the instrument via the interface.

13. Power Key

Powers on or off the instrument. When it is powered on, the power key indicator is constant on, illuminated in green.

4.2.3 Rear Panel

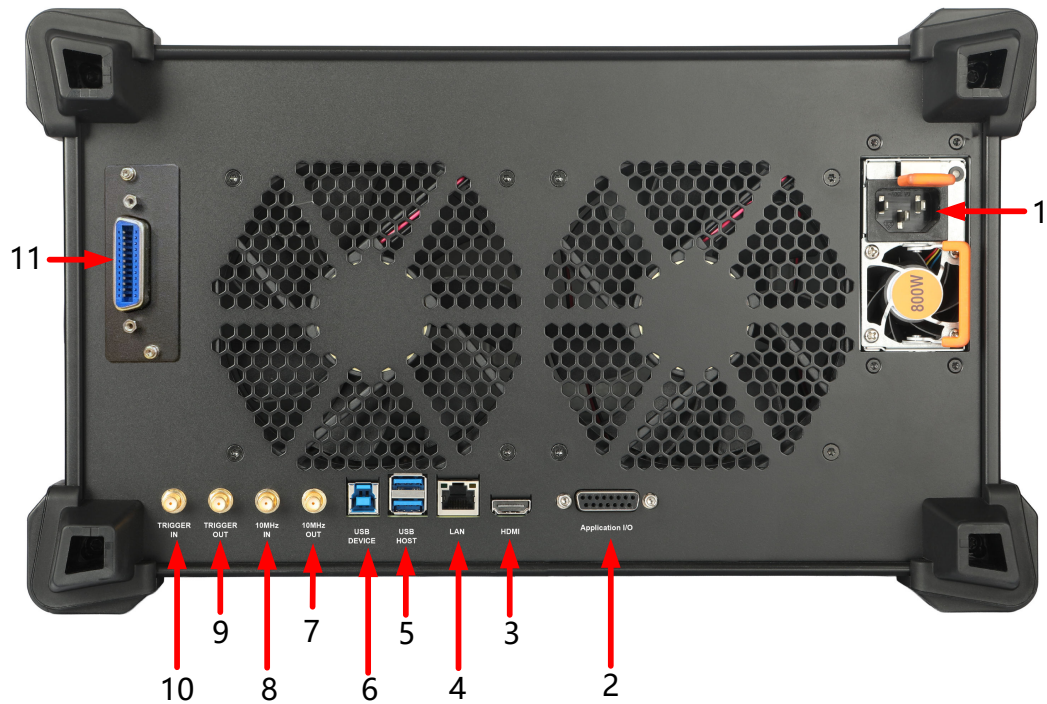

Figure 4.4 Rear Panel of DNA6000 Series

1. Power Socket

Used to connect to the 800 W power supply module.

2. Application I/O

DB15 Female connector. It is used to control the external slave device.

The connector transmits the following signals:

- Power: one 5V output and one GND;
- Control signal: PortA/PortB extension port, outputting 10 control signals;
- Information communication: UART (RX/TX) port, transmitting & receiving, alarming, cascaded control;
- Status indicator: slave feedback ALERT/DONE signal;

Table 4.1 Description of the Connector Pin

Pin No.	I/O	Type	Signal Name	Function	Remarks
1	P	POWER	VCC	5 V power output	Power pin

Pin No.	I/O	Type	Signal Name	Function	Remarks
2	P	POWER	GND	Ground pin	
3	O	TTL	PortA_EN	Whether to use PortA for extension	Enable PortA extension
4	O	TTL	PortA_bit0	PortA extension port bit0	PortA extension control pin 4-bit encoding for Port1-16 selection
5	O	TTL	PortA_bit1	PortA extension port bit1	
6	O	TTL	PortA_bit2	PortA extension port bit2	
7	O	TTL	PortA_bit3	PortA extension port bit3	
8	O	TTL	PortB_EN	Whether to use PortB for extension	Enable PortB extension
9	O	TTL	PortB_bit0	PortB extension port bit0	PortB extension control pin 4-bit encoding for Port1-16 selection
10	O	TTL	PortB_bit1	PortB extension port bit1	
11	O	TTL	PortB_bit2	PortB extension port bit2	
12	O	TTL	PortB_bit3	PortB extension port bit3	
13	I	TTL	UART_RX	Reports information from slave device to master device	UART communication pin
14	O	TTL	UART_TX	Sends information to the slave device from master device	
15	I	TTL	ALERT/DONE	Sends feedback signal to the master device from slave device	Status indicator pin Alert/Done

3. HDMI

Connects the instrument to an external display that has the HDMI interface (e.g. monitor or projector) via this interface to better observe the waveform display clearly. At this time, you can also view the waveforms on the LCD of the instrument.

4. LAN

Connects the instrument to network via this interface. The instrument is in compliance with the standards specified in LXI Device Specification 2011. It can be used to set up a test system with other standard devices. Then you can control the instrument through using Web Control to send the SCPI commands when the instrument is connected to the network.

5. USB HOST Interface

Two USB HOST interfaces, used for powering external devices and data interaction.

6. USB DEVICE

Connects the instrument to the PC via this interface.

7. 10 MHz OUT

An SMA connector that can output the 10 MHz clock signal generated by the internal crystal oscillator inside the instrument.

8. 10 MHz IN

SMA connector, used to input external reference clock signal.

9. TRIGGER OUT

SMA connector, used to output external trigger signal.

10. TRIGGER IN

SMA connector, used to input external trigger signal to the instrument.

11. GPIB

GPIB connector, used for instrument control and data interaction.

4.2.4 User Interface



No.	Description
1	Quick Operation Toolbar
2	Window Display Area
3	Function Menu Area
4	Notification Area
5	System Status Bar

4.2.4.1 Quick Operation Toolbar

The following figure shows the quick operation toolbar, and the table below it lists the functions of the quick operation keys on the toolbar at the top of the user interface.



No.	Description
1	Adds a new trace.
2	Adds a new channel.
3	Adds a new window.
4	Adds a new sheet.
5	Adds a new trace to a new window.
6	Adds a new trace and channel to a new window.
7	Adds a new trace and channel to a new window in a new sheet.
8	Adds a new trace and a new channel to a new window in a sheet.
9	Shortcut key for "Delete". By default, it deletes the Active Trace. If there is no Active Trace (i.e., an empty window), it deletes the Active Window. If the Sheet is empty, it deletes the Active Sheet, the last sheet cannot be deleted.
10	Manual trigger key.
11	Shortcut key for Auto Scale. Adjusts the parameters to the optimal state of the signal.
12	Saves the screenshot of the current screen.
13	Restores the system to preset settings. It functions the same as the front panel  key.
14	Displays the help document.

4.2.4.2 Window Display Area



No.	Description
1	Indicates sheet name. When there is only sheet, no sheet label is displayed. Click or tap the sheet tab to switch the sheet. You can also rename the sheet. Each sheet can contain multiple windows.
2	Indicates window. Traces can be displayed in the window. The definitions for the horizontal coordinate and vertical coordinate are related to the measurement parameter and data format. One sheet can display up to 9 windows. For the newly added windows, you can click or tap Pg Up or Pg Dn to view the desired window. <ul style="list-style-type: none"> • Single-clicking or tapping one window can make it become the active window. • Double-clicking or double-tapping the window area can maximize the currently selected window; double-clicking or double-tapping it again to restore to the multi-pane windowing. • Dragging the scale on the Y-axis can modify the reference level.
3	Indicates trace. It is a set of measurement data points. Clicking or tapping on the specified trace can select it as the active trace.
4	Indicates the trace number. Currently, it is not selected.

No.	Description
5	Indicates the trace number. Currently, it is selected.
6	Indicates the trace title. By default, it displays the test parameters.
7	Indicates the data format of the trace. In this figure, LogM indicates the log magnitude format.
8	Indicates Scale/Reference Level (related to the measurement data display format)
9	Indicates the stop frequency of the sweep.
10	Indicates the window number. Currently, the window is selected.
11	Indicates the trace for the channel. Its color is the same as the color of the trace for the specified channel.
12	Indicates the start frequency of the sweep.
13	Indicates the channel number.
14	Indicates the window number. Currently, the window is not selected.

4.2.4.3 Function Menu Area

Enter the Function Menu to make the settings.

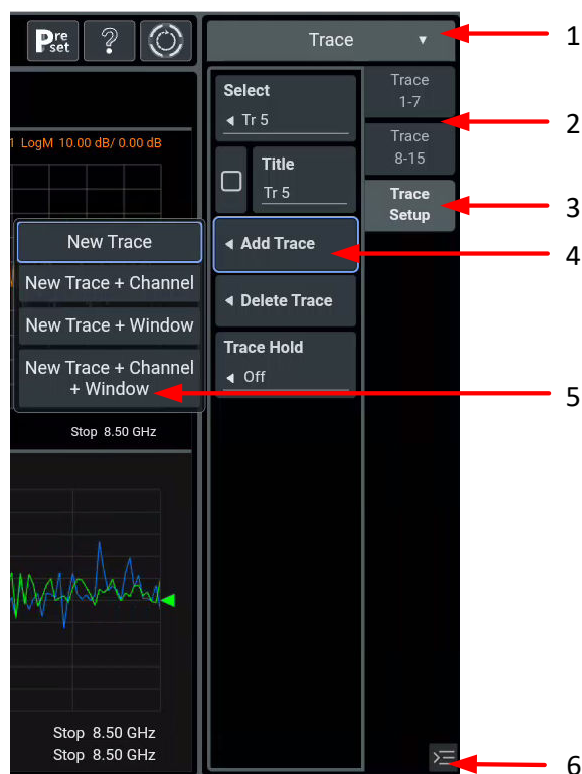

No.	Description
1	Function menu name. You can click or tap the drop-down button to switch to select other function menus.
2	Secondary sub-menu (unselected)
3	Secondary sub-menu (selected)
4	Third-level sub-menu. You can click or tap the drop-down button (<) to select the sub-menu under it.
5	Forth-level sub-menu
6	Shows/Hides the function menu

4.2.4.4 System Status Bar

Displays the main parameters of the current system status.

Tr 1	Ch 1	Internal Trig	Continuous	BW=100 kHz	No Correction	RF ON
↑	↑	↑	↑	↑	↑	↑
1	2	3	4	5	6	7

No.	Description
1	Active trace
2	Active channel
3	Trigger source. Currently it is set to internal trigger. It can be configured in the Trigger menu.
4	Trigger mode, currently set to continuous trigger. It can be configured in the Trigger menu.
5	IF bandwidth, which can be set in the Avg BW menu.
6	Calibration type. After calibration, it displays the calibration type. If correction is disabled, it displays No Correction.
7	Internal stimulus source. It displays the RF power status for all channels and can be configured in the Power menu.

4.2.4.5 Notification Area

Displays LAN icon, sound icon, and remote control icon as well as date and time. You can click or tap this area to open the "System" menu.



No.	Description
1	Remote control icon. When you use Web Control to control the instrument remotely, Rmt will be displayed.
2	LAN icon. When the LAN interface is successfully connected, LXI is displayed.
3	Sound icon. Click or tap this icon to turn on or off the sound. When enabled, will be displayed ; when disabled, will be displayed.
4	Date: displays the system date. You can set it in the Setting sub-menu under System .
5	Time: displays the system time. You can set it in the Setting sub-menu under System .

4.3 To Prepare for Use

4.3.1 To Connect to Power

Please use the power cord provided in the accessories to connect the spectrum analyzer to the AC power source. The AC power source supported by the instrument is 100-240 V, 50-60 Hz. The power consumption of the instrument cannot exceed 100W(400VA). When the spectrum analyzer is connected to the AC power source via the power cord, the instrument automatically adjusts itself to within the proper voltage range, and you do not need to select the voltage range manually.







Figure 4.5 Connect to Power



CAUTION

To avoid electric shock, ensure that the instrument is correctly grounded.

4.3.2 Turn-on Checkout

- **Power on**
 - After connecting the instrument to the power source properly, press the power key  on the lower-left corner of the front panel to power on the instrument. During the start-up process, the instrument performs a series of self-tests. After the self-test, the splash screen is displayed.
 - Click or tap the Notification Area and select **Setting** > **Power Switch** in the displayed **System** menu. By default, the **Power Switch** menu is enabled. The instrument will be powered on automatically after the instrument is connected to power.
- **Shutdown**
 - Press the power key  and a prompt message "Are you sure to shutdown?" is displayed. Click or tap **OK** to shut down the instrument.
 - Press  twice to directly shut down the instrument.
 - Press  for three seconds to directly shut down the instrument.

4.3.3 To Set the System Language

This series supports multiple system languages. To select the desired language, click or tap the notification area at the lower-right corner of the screen to select **Setting** > **Language**.

4.4 Basic Operation

This chapter introduces the basic operation of the instrument.

4.4.1 Mouse/Keypad Board/Touch Screen Operation Rule

Mouse Operation Rule

Connect the mouse to the instrument via the USB HOST interface to perform the following operations. Note that you can only use the left mouse button to perform the left-click operation. Right-click and mouse rolling operation are not allowed.

1. Click the mouse to select the menu and window.
2. Long press the left mouse button to drag the displayed data or window.

3. In the Marker menu, click the mouse to move the marker, but you are unable to use the mouse to add a marker.

Keypad Board Operation Rule

After the keypad board is properly connected to the instrument via the USB HOST interface, and then you can use the shortcut keys on the keypad to perform the same function as what you do with the Function Key.

Touch Screen Operation Rule

The instrument has a 10.1" capacitive multi-touch screen, supporting many gesture-enabled touch operations.

- **Tap:** use one finger to tap the symbol or characters on the screen slightly.
 - Tap the menu and function key to make function settings.
 - Tap the input field and the virtual keypad will pop up for parameter setting.
 - Tap the window and its tab bar to perform operations on the window.
- **Drag:** use one finger to select the object, and then drag the object to a destination place.
 - Drag the window or cursor to change the position of the window or cursor.
 - Drag the slider in the menu to change the function settings.
- **Pinch&Stretch:** pinch or stretch two points on the screen with two fingers to zoom in or out the waveform.

You can zoom in or out the scale of the horizontal coordinate (X-axis) and vertical coordinate (Y-axis) of the window.

4.4.2 Menu Operation

The menu operation includes the following types.

1 Input a Parameter Value



Click or tap the specified menu, then use the numeric keys to modify the value directly.

2 Select a Parameter

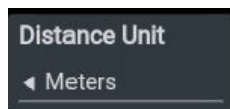

Click or tap the specified menu, its sub-menus are displayed. Select the desired parameter from the drop-down list.

3 Switch between the Option Tab

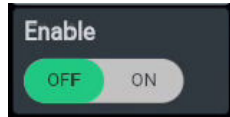

Click or tap the desired tab to switch between the alternative tab.

4 Select a Sub-menu

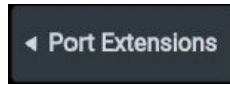

Click or tap the specified menu with the cascading sub-menus to select the specified sub-menu.

7 Direct Execution

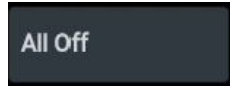

Click or tap the specified menu to execute the corresponding function.

6 Check to Enable the Function (without parameter)

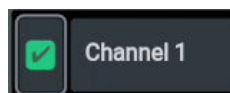

Check the checkbox of the specified menu to enable the function. If the checkbox turns green, with a tick in it, this function is enabled.

5 Check to Enable the Function (with parameter)

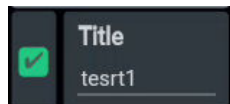

Check the checkbox of the specified menu to enable the function. Then click or tap the parameter input field to input the value or characters to modify the parameter.

Check the checkbox of the specified menu to enable the function. If the checkbox turns green, with a tick in it, this function is enabled.

8 Menu Selected

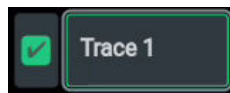

Click or tap the specified menu, and the selected menu is highlighted in a green box. You can click or tap the desired marker, trace, channel, window, or sheet to make them be selected.

TIP

The above menu operations can also be realized through externally connected mouse, touch screen operation, or Web Control operation.



4.4.3 Parameter Setting Method

The parameters can be set by using the front-panel numeric keypad, knob, arrow keys, touchscreen or external keypad and mouse. The parameter setting methods are as follows:

1. Numeric Keypad

When the input box is selected, make parameter setting via the numeric keypad on the front panel.

2. Knob

When the parameter is in editing mode, rotate the knob clockwise to increase or counterclockwise to decrease the parameter value at the specified step.

3. Arrow Keys

When the parameter is in editing mode, use the arrow keys to increase or decrease the parameter value at the specified step. Note that the step sizes for the Up/Down arrow key and the Left/Right arrow key are different.

4. Touchscreen

Use a finger to touch the screen and select the input box. Complete the parameter setting with the displayed virtual keypad with your finger.

5. External Keypad

When the input field is selected, make parameter setting via the external keypad.

6. External Mouse

Use the external mouse to select the input field. Complete the parameter setting with the displayed virtual keypad with the external mouse.

4.4.4 To Use the Built-in Help System

The built-in help document of the vector network analyzer provides information about the functions and menu introductions of the instrument.

Click or tap the help icon on the quick operation toolbar at the top of the main interface, then the Help documentation is displayed. You can get its help information by clicking on the link for the introduction of the specified function.

4.4.5 To View the Option and the Option Installation

This series vector network analyzer provides many options to meet various measurement requirements. If you need any of these options, order them according to the Order No. available in Data Sheet, and then install the options according to this section. Besides, you can also view the options currently installed on the vector network analyzer and activate the newly purchased option.

1. View the Installed Option

If your instrument has currently installed the option, perform the following operations to view the name of the installed option and other detailed information about the option from the option list.

Click or tap the notification area in the lower-right corner of the screen to pop up the system menu. Click or tap **Options** to view the options currently installed.

2. Install the Option

The option license is a string with a fixed number of characters. Each instrument has one unique license. The license file should be in specific format, with the filename extension "*.lic". After you purchase an option, you will obtain a key (used

for obtaining the license). Then, you can install the option according to the following steps.

a. Obtain an option license

Log in to the RIGOL official website (<http://www.rigol.com>), click **SERVICE CENTER** > **LICENSE ACTIVATION** to enter the license activation interface.

Input the correct key, serial number (click or tap **About** to acquire the serial number of the instrument), and verification code. Click **Generate** to acquire the download link for the option license file.

b. Install the option

Install the option by sending SCPI commands. For details, refer to *Programming Guide* of the product. After installation, a prompt message "Option activated successfully" is displayed. After the option has been installed, you are recommended to restart the instrument.



TIP

- During the installation process, you are not allowed to power off the instrument.
- Installing options by sending SCPI commands is supported. Installing options by inputting the license code manually is not supported.

4.5 Basic Test Procedures

The following procedures guides you how to make the measurement settings for the analyzer.

1. Set the Measurement

Sets the analyzer, creates the measurement, and adjusts the measurement display.

- a. Use the preset settings or user-defined settings of the analyzer: you can preset the analyzer (*Preset*) or recall (*Recall*) the user-defined settings.
- b. Create a channel (*Channel*) and a trace (*Trace*).
- c. Select a measurement parameter (*Measure*).
- d. Set the sweep type and points (*Sweep*).
- e. Set the frequency span (*Frequency*).
- f. Set the port power (*Power*).
- g. Set the trigger (*Trigger*).
- h. Set the data format (*Data Format*).
- i. Set the scale (*Scale*).

- j. Set the user-defined window display (*Window Setup* and *Sheet Setup*).

2. Optimize the Measurement

A measurement has many interdependent settings. You can modify the settings to achieve faster processing or greater measurement accuracy.

Achieve Faster Processing

- Fast sweep (*Sweep*)

Use the sweep frequency span required for the measurement device

Use the minimum number of points required for the measurement

Segment sweep: use segments to focus test data only where you need it.

Auto sweep time: use this default to sweep as quickly as possible for the current settings.

- Disable the unnecessary functions, including *Trace*, *Marker*, *Smoothing*, *Limit Test*, etc.
- Use SCPI commands to remotely control (*Remote Control*) the VNA via LAN interface to performance auto measurement.

Improve Measurement Accuracy

- Increase dynamic range
- Reduce noise, including *Averaging State/Averaging Times*, *IF BW*, and *Smoothing*.
- Group Delay (*Group Delay Aperture*)
- Set the electrical delay (*Electrical Delay*), phase offset (*Phase Offset*), and port extension (*Port Extension*) to improve the phase measurement accuracy.

3. Perform the Measurement Calibration

Performs the calibration to reduce the measurement errors.

- Basic calibration: Selects the calibration type (*S-parameter Calibration Type Supported by VNA*) and calibration kits (*Calibration Kits*). You can select the available calibration kits from the standard calibration kits, and can also load the user-defined calibration kit (*To Save or Recall the CalSet File*). You can also

load the user-defined calibration sets file to recall the calibration data. Note that the calibration sets file you recalled shall match the current sweep settings.

- Electronic calibration: You can select the desired electronic calibration kit (*Electronic Calibration*) based on the selected calibration type and port to perform the calibration.
- Advanced calibration function: Port extension (*Port Extension*), port match (*Port Match*), port Z (*Port Z*), and 2-port DeEmbed (*2-port DeEmbed*).

4. Analyze Data

Analyzes the measurement results with marker, math operations, and limit tests.

- *Marker* function provides the readout of measured data, searches for specific values (*Search*), and modifies the stimulus settings. Each trace has 15 normal markers and one reference marker (used with Delta marker).
- Use the data math operation (*Memory*) to perform four types of math operations on the active trace and memory trace.
- The limit line measurement function (*Limit Test*) allows you to compare the measurement data with the user-defined conditions.

5. Save and Recall Data

Saves (*Save*) and recalls (*Recall*) measurement data files to and from an internal or external storage device in various formats. The file formats include:

- Instrument state and calibration data (*.csa, *.sta, and *.cal)
- Measured data file (*.snp and *.csv)

5 Trace

Traces are a series of measured data points. The data points in one measurement share the same trace number and are saved as one trace.

- Each sheet supports up to 100 traces. Up to 500 windows are supported.
- One channel supports 16 traces.

The trace state information is displayed at the top of each window. The trace number highlighted indicates the current active trace. For details, refer to [User Interface](#).

The trace setup will affect the presentation and math operations of the measurement data. The following lists the trace related items for trace setup.

- Measurement Parameter, Parameter Conversion
- Format and Scale
- Averaging, Smoothing
- Correction ON/OFF
- Electrical Delay
- Phase Offset, Amplitude Offset
- Trace Math
- Markers
- TDA, DTF

5.1 Trace 1-8/Trace 9-16

Creates and selects the desired trace quickly. Click or tap the checkbox of the specified trace to select it. Uncheck the checkbox of the specified trace to remove the trace.

Create the Trace

Click or tap the checkbox of the specified trace from the **Trace 1-8** and **Trace 9-16** menus to create the trace quickly. When the trace is available on the screen, the checkbox ahead of the specified trace is highlighted in green. When the specified trace is selected, the trace name is highlighted in green box.

After the trace is created, the trace is available in the current active window and the current active channel. S11 parameter is measured by default.

Add a Trace

Click or tap **New Traces...**, then the trace adding interface is displayed, as shown in the figure below.

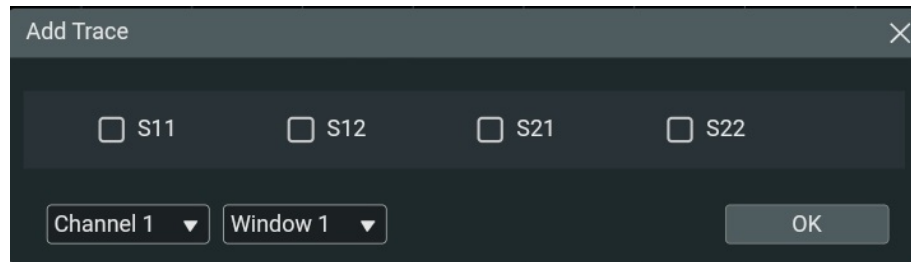

Select the window, channel, and the measurement parameter for the trace. If there is no available channel or window to choose, you can add a new channel or window first, then create the trace for the channel and the window.

5.2 Trace Setup

In **Trace Setup** menu, you can select the specified trace, add or delete the trace, modify the trace title, and set the trace hold.

Select a Trace

Select a trace as the current active trace. Click or tap the drop-down button of "Select" to select the desired trace. Select the desired trace in the "Trace 1-8" or "Trace 9-16" menu. You can also click or tap the target trace label at the upper-left corner of the window to select the desired trace. To modify the trace title, first select the trace to make it active, then modify the title.

Modify the Trace Title

Select the specified trace and then modify the trace title. You can also hide the trace title.

- By default, no trace title is added, and it displays the S-parameter of the trace measurement. If a trace title is added, it displays the trace title.
- Hide the title: Uncheck the checkbox of the title of the specified trace to hide the trace title, making the window look simple and precise.
- Modify the title: Check the checkbox of the title of the specified trace, then modify the title of the trace.

Add a Trace

To add a trace, perform the following operations.

- **New Trace:** adds a trace in the current window. The trace is added on the active channel in the current active window. The trace property is default.
- **New Trace + Channel:** creates a new channel in the current active window and creates a new trace on the channel. The trace property is default.
- **New Trace + Window:** creates a new window and creates a new trace in the window. The newly created trace belongs to the active channel.
- **New Trace + Channel + Window:** creates a new window and creates a channel in the window; creates a new trace on the current on the channel. The trace property is default.
- **New Traces...:** For details, refer to [Add a Trace](#).

Delete a Trace

Click or tap **Delete Trace** to select the desired trace to be deleted. The selected trace will be deleted.

Trace Hold

The trace hold function holds the current active test trace, that is, the trace data remain unchanged under certain conditions.

When trace hold is enabled, the trace data will stay unchanged on the screen until you disable the trace hold function or perform other operations to change the displayed contents. When Max or Min is selected for Trace Hold, hold the active trace at the maximum and minimum points in a certain period, helping users make extrema analysis.

- **Off:** disables trace hold function for the specified trace.
- **Max:** the trace keeps updating, and if new measurement value is greater than the current max. hold value, then the new max. value prevails. The displayed trace always represents the maximum measurement value at each frequency point since the trace hold max is enabled.
- **Min.** the trace keeps updating, and if new measurement value is smaller than the current min. hold value, then the new min. value prevails. The displayed trace always represents the minimum measurement value at each frequency point since the trace hold min is enabled.

- **Restart:** resets the trace data and restarts to launch the measurement based on the currently selected trace hold type.

6 Channel

In the **Channel** menu, you can configure the settings for the channel, window, and sheet.

The features of channels in the VNA device:

1. Signal transmission: Each channel is responsible for sending RF signal from the test port to the DUT and receiving the reflection signal for measurement and analysis.
2. Independent: Each channel is independent of each other and can be configured and controlled independently. Therefore, the instrument can make multiple measurements at the same time or calibrate on different ports.
3. Flexible to measure: Multiple channels are supported, enabling you to measure the S-parameters of different ports and make a comprehensive analysis for the multi-port network.
4. Calibration and correction: Each channel can be calibrated and corrected independently, ensuring the accuracy and reliability of the test results.
5. Data processing: Each channel receives and processes the signal sent from the DUT for data acquisition, analysis, and display.

6.1 Channel 1-9

Channel determines how to measure and process signals in the VNA device. Each channel generally consists of a transmit port and a receiver port, which are used to transmit and receive RF signal, then make signal analysis and measurement. Each channel has a unique number, and up to 500 independent channels are supported.

The channel settings determine how the trace data is measured. All the traces that are assigned to a channel share the same channel settings. To modify the channel setting, first select the channel.

Click or tap **Channel 1-9** to enter its sub-menu. 9 channel menus are displayed. If the checkbox at the left part of the specified channel name is checked and highlighted in green, it indicates that the channel is available. If the channel name is highlighted in green box, it indicates that the channel is selected. By default, Channel 1 is selected.

- If a channel does not exist, check the checkbox of the specified channel name to create the channel quickly. If a channel already exists on the screen, uncheck the checkbox of the specified channel name to delete the channel quickly.
- After deleting the channel, all the traces on the channel will all be deleted.
- Each time you create a channel, a trace (S11 logM trace by default) is automatically created. A channel without trace does not exist.
- A window can contain no channels or traces. Even if you delete all the channels and traces from the window, the window without any channels and traces can still exist.

6.2 Channel Setup

Select a Channel

Click or tap the drop-down button of **Select**, then all the available channels are displayed to choose. Choose the desired channel to be the selected channel. If you select one trace, then the channel where the trace is located is also selected.

If you need to modify the parameters of the specified channel, first select the channel.

Add a Channel

Click or tap the drop-down button of **Add Channel** to add the desired channel.

- **New Trace + Channel:** creates a new channel, and creates a new trace for the new channel in the current active window.
- **New Trace + Channel + Window:** creates a new window and a new channel; creates a new trace for the new channel in the new window.

The newly created window, channel, and trace are automatically selected.

New IDs with the minimal number that is not in use will be assigned to the newly created window, channel, and trace

Delete a Channel

Click or tap **Delete Channel**, then all the existing channels are displayed in the pop-up sub-menu, select the desired channel to delete it.

Once the channel is deleted, all the traces contained in the channel will all be deleted.

If the currently selected channel is deleted, the channel with the smaller ID number will become the newly selected channel.

6.3 Window 1-9

Windows are used to view traces. Each sheet can contain up to 100 traces. The total number of trace in all the windows in the current sheet cannot exceed 100. The instrument supports creating 500 windows, and each window has a unique ID, which is indicated at the lower-left corner of the window. At most, 9 windows can be displayed on the screen at the same time. If new windows are added, click or tap **Pg Dn** to view more windows.

Window Management

Click or tap **Window 1-9** to enter its sub-menu. 9 window menus are displayed. If the checkbox at the left part of the specified window name is checked and highlighted in green, it indicates that the window is available. If the window name is highlighted in green box, it indicates that the window is selected.

- If you want to create a window on the screen, check the checkbox of the specified window name to create the window quickly.
- If you want to delete a window that already exists on the screen, uncheck the checkbox of the specified window name to delete the window quickly.
- After deleting the window, all the traces in this window will all be deleted. If all traces in this channel are deleted, then this channel will also be deleted.

Trace Information in the Window

One of the important functions of the window is to display trace curves. A window can contain up to 100 traces. The trace information of the window is displayed at the top of the window. For details, refer to *User Interface*.



```

TR5 test LogM 10.00 dB/ 0.00 dB
TR8 S11 LogM 10.00 dB/ 0.00 dB
  
```

The trace with different data formats can all be displayed in one window. The definitions for the horizontal coordinate (X-axis) and vertical coordinate (Y-axis) in different trace formats are different. The scale type shown in the vertical coordinate indicates the Y-axis type of the currently activated trace.

Channel Information in the Window

The channel information of all the traces in the window is displayed at the bottom of the window.



```

5 Channel4: Start 100.00kHz — Stop 26.500GHz
>Channel7: Start 100.00kHz — Stop 26.500GHz
  
```

- ">" following a channel No. indicates the currently selected active channel. Only one channel can be activated globally.
- The definitions for the Start and Stop values are determined by the sweep type of the channel. For power sweep, they indicate power values; for frequency sweep, they indicate frequency values.
- When multiple channels are available, they are displayed from top to bottom in sequence.
- The line(s) with different color(s) following the Start value indicates all the traces of this channel. The line color is the same as the color of the trace displayed in the window. If multiple traces are available for the channel, they will be displayed from left to right in sequence.

6.4 Window Setup

Select a Window

Click or tap the drop-down button of **Select**, then all the available windows are displayed to choose. Choose the desired window to be the new active window. The selected window is highlighted in green box.

Window Title

Click or tap the input field of "Title", then the virtual keypad is displayed. Input the title of the current active window with the virtual keypad.

Add a Window

Click or tap the drop-down button of **Add Window** to add the desired window.

- **New Window:** creates a new window.
- **New Trace + Window:** creates a new window and creates a new trace for the currently activated channel in the window.
- **New Trace + Channel + Window:** creates a new window, creates a new channel, and creates a new trace for the new channel in the window.

The newly created window, channel, and trace are automatically activated. New IDs with the minimal number that is not in use will be assigned to the newly created window, channel, and trace.

Delete a Window

Click or tap the drop-down button of **Delete Window**. All the available windows are displayed to choose. Select the desired window to delete it. Note that the window with the green dot located at the left indicates that it is currently selected and activated.

Once the window is deleted, all the traces contained in the window will all be deleted. If all traces in this channel are deleted, then this channel will also be deleted.

If you delete the currently activated window, then the window with the minimal ID not in use among all of the current windows will automatically become the new active window.

6.5 Sheet Setup

Sheets are used to group multiple windows. Multiple sheet tabs can be displayed on the screen. By default, there is only one sheet when you power on the instrument. When multiple sheets are available, there will be multiple sheet tabs. Click or tap the specified sheet tab to switch to the desired sheet. Each sheet can contain multiple windows. For details, refer to *User Interface*.

Select a Sheet

To select an active sheet, perform either of the following operations, perform either of the following operations.

- Click or tap the drop-down button of **Select**, then all the available sheets are available to choose. Select the desired sheet to make it active.
- Click or tap the sheet tab to switch the sheet. The selected sheet is the active sheet.

Sheet Title

Click or tap the input field of "Title", then the virtual keypad is displayed. Input the title of the current active sheet with the virtual keypad. The sheet tab name will also be updated once you have modified the sheet title.

Add a Sheet

Click or tap the drop-down button of **Add Sheet** to add the desired sheet.

- **New Sheet:** creates a new sheet.
- **New Trace + Sheet:** creates a new sheet and creates a new window in the sheet.

Create a new trace for the currently activated channel and display it in the window.

- **New Trace + Channel + Sheet:** creates a new sheet and creates a new window in the sheet. Create a new channel. Create a new trace for the new channel and display it in the window.

The newly created sheet, window, channel, and trace are automatically activated. New IDs with the minimal number that is not in use will be assigned to the newly created sheet, window, channel, and trace.

Delete a Sheet

Click or tap the drop-down button of **Delete Sheet**. All the available sheets are displayed to choose. Select the desired sheet to delete it. Note that the sheet with the green dot located at the left indicates that it is currently selected and activated.

Once the sheet is deleted, all the windows in the sheet and all the traces contained in the window will all be deleted. If all traces in this channel are deleted, then this channel will also be deleted.

If you delete the currently activated sheet, then the sheet with the minimal ID not in use will automatically become the active sheet. If there is only one sheet left, this last sheet cannot be deleted.

7 Frequency

Sets the frequency parameters of the stimulus source.

Frequency Range

Specifies the frequency range for the measurement. Only when you set the sweep type to "Linear Frequency" or "Log Frequency", can you set the frequency range. After configuring the frequency range, the start frequency and stop frequency values are displayed at the bottom of the window.

Click or tap **Frequency** > **Main** to set the start frequency, stop frequency, center frequency, and span. They have a coupling relationship. Once you modify one of them, the rest three parameters will also be modified accordingly. The frequency step (Step) is calculated based on the Span value.

- $f_{\text{Center}} = (f_{\text{Start}} + f_{\text{Stop}}) / 2$
- $f_{\text{Span}} = (f_{\text{Stop}} - f_{\text{Start}})$
- $f_{\text{Step}} = f_{\text{Span}} / (\text{number of sweep points} - 1)$

CW Frequency

CW (Continuous Wave) refers to an electromagnetic wave characterized by constant frequency and constant amplitude. Only when the sweep type is "Power", can this menu be enabled.

The range of the CW frequency is from 5 kHz to 26.5 GHz. By default, it is 1 GHz. Once the CW value is set, it will be displayed at the bottom of the window.

8 Sweep

A sweep is a series of consecutive data point measurements taken over a specified sequence of stimulus values. The sweep settings are valid for the current channel. All the measurement traces for each channel share the same sweep parameters.

8.1 Main

VNA supports multiple types of sweep. The relevant information is displayed below the window, as shown in the figure below.

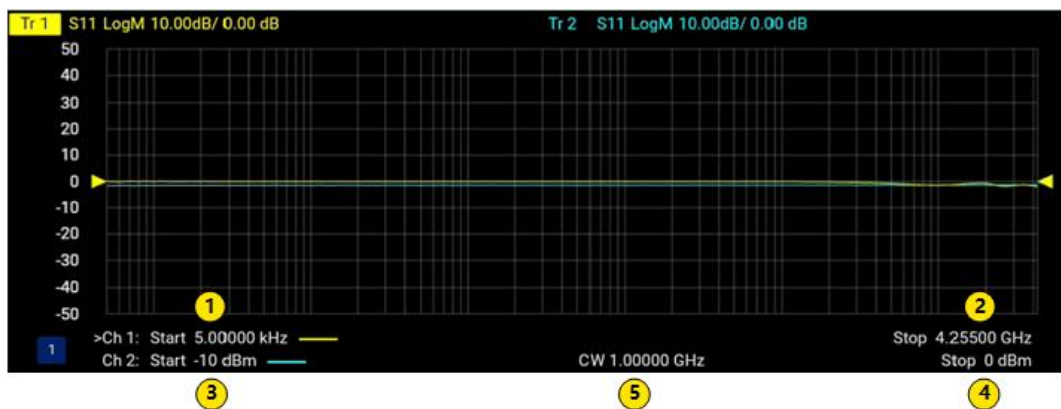

Linear Frequency

X-axis represents the linear frequency, displayed with equal horizontal divisions in the X-axis. You need to set the start frequency, stop frequency, and sweep points for the linear frequency sweep.

- Start Frequency:** sets the start value of the frequency sweep or the start point of the X-axis. It is displayed at the bottom of the window, following "Start", as ① indicated in the above figure. This menu functions the same as the start frequency in **Frequency** menu (click or tap **Frequency** > **Main** > **Start**). Configuration of this parameter in both **Sweep** and **Frequency** menus has the same effect.
- Stop Frequency:** sets the stop value of the frequency sweep or the stop point of the X-axis. It is displayed at the bottom of the window, following with the "Stop" icon, as ② indicated in the above figure. This menu functions the same as the stop frequency in Frequency menu (click or tap **Frequency** > **Main** > **Stop**).

Configuration of this parameter in both **Sweep** and **Frequency** menus has the same effect.

Log Frequency

The X-axis is the frequency stepped in logarithmic increments and the data is displayed on a logarithmic X-axis. This mode allows you to observe wide frequency range. The grid is not equally spaced and varies periodically. This is usually slower than a continuous sweep with the same number of points. It is slower than linear frequency sweep.

The Log frequency sweep also needs to set the start frequency, stop frequency, and sweep points. The setting method is the same as that in "Linear Frequency" sweep.

Power Sweep

Activates the power sweep at a single frequency that you specify. The power sweep either increases or decreases source power in discrete steps. X-axis represents the linear power.

- You need to set the start power, stop power, and sweep points for the power sweep. Wherein, start power indicates the start value of the power sweep or the start point of the X-axis. It is displayed at the bottom of the window, following "Start", as ③ indicated in the above figure. Stop power indicates the stop value of the power sweep or the end point of the X-axis. It is displayed at the bottom of the window, following "Stop", as ④ indicated in the above figure.
- To set the fixed frequency value of the sweep signal, click or tap **Frequency** > **Main** > **CW**, then input the desired value into the input field of CW. The CW value is displayed at the bottom of the window, as ⑤ indicated in the above figure.
- Power sweep is optimized for speed. For highest measurement accuracy during a power sweep, it may be necessary to increase the Dwell Time to allow the source more time to settle. To set the dwell time, click or tap **Sweep** > **Sweep Timing** > **Dwell Time**.
- The **Start** and **Stop** sub-menus in the **Sweep** menu have the same function as that in **Power** menu (click or tap **Power** > **Main** > **Start** and **Stop**). Configuration of the two parameters in both **Sweep** and **Power** menus has the same effect.

Segment Sweep

Segment sweep refers to user-defined one or multiple frequency ranges of sweep (called segment). For each segment, you can define independent power level, IF bandwidth, IF bandwidth per port, sweep time, delay time, and dwell time. All the segments are swept in order, just as other sweep operation.

X-axis represents the linear incremented frequency value, and its display format is the same as described in the "linear frequency sweep". For detailed setting methods for the segment sweep, refer to the descriptions in *Segment Control*.

Sweep Points

Sweep points refer to the number of data points acquired in single sweep. The range of the sweep points is from 1 to 100,001. By default, it is 201.

- When the sweep type is "Segment", sweep points cannot be set.
- When you modify the sweep points, the instrument starts to re-sweep all the channels according to the channel No. sequence.
- To achieve the greatest trace resolution, use the maximum number of data points. However, the sweep time changes proportionally with the number of points. To obtain higher throughput, keep the number of points to a smaller value within an allowable trace resolution.
- To ensure an accurate measurement calibration, ensure that the number of sweep points used in calibration is consistent with that used in measurement.

8.2 Sweep Timing

The following figure lists the relationship between the sweep time, delay time, and dwell time. Point Delay in the figure refers to the dwell time.

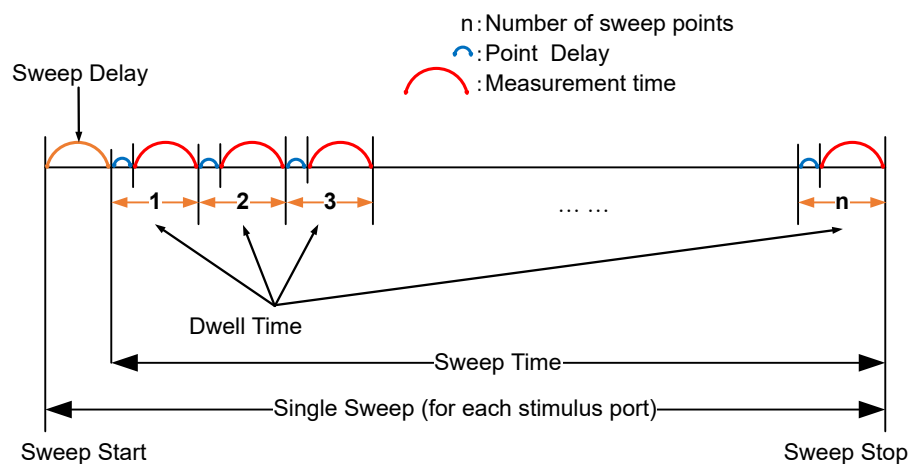

Sweep Time

Sweep time specifies the time the VNA instrument takes to acquire RF data for a sweep.

The sweep time includes the dwell time but does not include the sweep delay time.

Auto Sweep Time

- **Auto (Default):** auto adjusts the sweep time, and the dwell time is fixed to be 0 s. If you set the dwell time to a value other than 0, then manual sweep time configuration is automatically enabled.
- **Manual:** sets the sweep time and dwell time manually. When you configure the dwell time to 0, then auto sweep time configuration is automatically enabled.

Dwell Time

Specifies the time the VNA instrument stays at each measurement point to complete the signal stimulus, response acquisition, and data processing. The max. dwell time is 20 s.

Increasing the dwell time will slow the sweep speed, but it increases the measurement accuracy for the electrically long device.

Delay Time

Specifies the time to wait just before acquisition begins for each sweep. By default, it is 0 s. Its range is from 0 s to 20 s. This delay is in addition to Dwell Time (per point) and External Trigger delay if enabled.

Sweep Sequence

- **STD:** by default, it is standard sweep. The analyzer sweeps all data points for each source port in sequence. For example, first sweep the S11/S21 parameters of all the data points, then sweep the S12/S22 parameters of all the data points.
- **Point:** the analyzer measures all S-parameters at each frequency point before stepping to the next frequency. The display trace is updated as each data point is measured. Point sweep usually slows the sweep and is useful only in rare circumstances.

8.3 Segment Control

If you set the sweep type to Segment, you need to configure settings for each segment. Each channel supports up to 32 segments. This instrument supports up to 4,096 segments.

Add a Segment

Adds a sweep segment at last segment. A new line of segment parameters will be added in the segment table.

- The start frequency of the newly added segment is the stop frequency value of the last segment.
- The added segment will not change the current active segment.

Insert a Segment

Inserts a sweep segment before the selected segment. A new line of segment parameters will be inserted before the selected segment in the segment table.

- For the inserted segment, by default, its start frequency is the stop frequency of its previous segment; its stop frequency is the start frequency of its next segment.
- After the new segment is inserted, the new inserted segment is, by default, selected as the current active segment.

Delete a Segment

Deletes a specified segment from the segment table. If there is only one segment, after the segment is deleted, the sweep type automatically changes to linear frequency sweep.

Delete All Segments

Deletes all of the segments from the segment table. After all segments are deleted from the segment table, the sweep type automatically changes to linear frequency sweep.

Configure the Segment Table

The segment table and the segment table configuration information are displayed in the following figure.

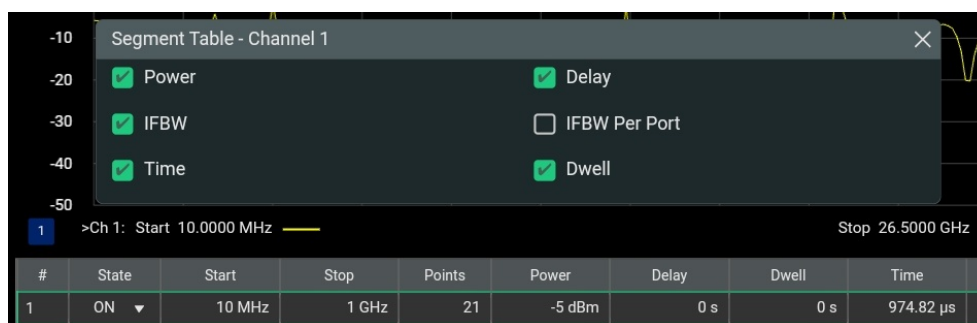

By default, the segment table includes the following parameters: segment No., on/off status of the segment, start frequency, stop frequency, and sweep points. Check the checkbox of the specified parameters that you want to display in the segment table, and then the relevant parameters will be displayed in the segment table. Note that "IFBW" and "IFBW Per Port" are mutually exclusive, and they cannot be selected at the same time.

Click or tap the specified parameter value in the segment, then the numeric keypad is displayed, input the desire value to complete parameter configuration. For the state setting, click or tap the drop-down button of **State** to enable or disable the state of the specified segment. Restrictions for segment sweep configuration:

- The frequency range of a segment is not allowed to overlap the frequency range of any other segment. The start frequency of each segment must be greater than the stop frequency of its previous segment.
- When the start frequency of a specified segment is smaller than the stop frequency of its previous segment, a prompt message is displayed, prompting you to set IF bandwidth to 500 Hz, and automatically set the stop frequency of the previous segment to the start frequency of the current segment.
- At least one segment must be enabled, otherwise, the sweep type automatically switches to the linear frequency sweep.
- Up to 32 segments are supported.
- The combined number of data points for all segments in a sweep cannot exceed the max number of data points per trace.
- Each segment is ordered based on the frequency value from high to low.

Display the Segment

Controls whether to display the segment table below the window.

- **Auto:** (Default)

- Only when you click or tap **Sweep** > **Segment Table** to enter the sub-menu of **Segment Table**, can the segment table be displayed below the current active window automatically.
- When you select other sub-menus other than **Segment Table** under **Sweep**, the segment table will not display below the current active window.
- **On:** When the current active channel is segment sweep type, the segment table of the current active channel is displayed below the current active window.
- **Off:** segment table is not displayed below the current active window.

9 Measure

The **Measure** menu enables you to set the measurement parameters for the trace.

9.1 S-Parameter

S-parameters are used to describe the situation of transmission and reflection signals when a signal meets a discontinuity in impedance. S-parameters are relative parameters, defined as the ratio of two complex voltages, containing amplitude and phase information of the related signals.

- Response port, also known as the receiver port of the vector network analyzer.
The transmitted signal goes to this port via the DUT.
- Stimulus port, also known as transmit port of the vector network analyzer. The output signal on this port goes to the DUT.

For the 2-port vector network analyzer, there are 4 S-parameters: S11, S21, S12, and S22. The definition for each S-parameter is shown in the following figure.

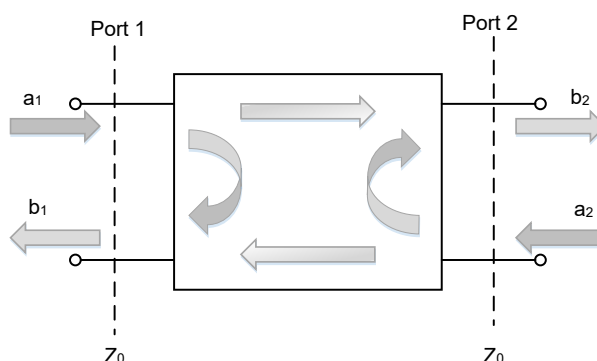

When the source goes to Port 1, the measurement is said to be in the forward direction. When the source goes to Port 2, the measurement is said to be in the reverse direction. The analyzer switches the source and receiver automatically to make a forward or reverse measurement. Therefore, the analyzer can measure all of the four S-parameters for a 2-port device with a single connection.

- S11 - forward reflection
- S21 - forward transmission
- S12 - reverse transmission
- S22 - reverse reflection

The formula is shown as follows:

$$S_{11} = \frac{b_1}{a_1} \Big|_{a_2=0} \quad S_{21} = \frac{b_2}{a_1} \Big|_{a_2=0} \quad S_{12} = \frac{b_1}{a_2} \Big|_{a_1=0} \quad S_{22} = \frac{b_2}{a_2} \Big|_{a_1=0}$$

Click or tap the specified S-parameter to set the specified measurement parameters for the currently activated trace.

Table 9.2 Common Measurement with S-Parameters

Measurement Type	Measurement Parameter
Reflection Measurement	Return Loss SWR Reflection Coefficient Input Impedance S11, S22
Transmission Measurement	Insertion Loss Transmission Coefficient Gain/Loss Group Delay Deviation from Linear Phase Electrical Delay S21, S12

9.2 Meas Setup

Parameter Conversion

Refer to descriptions in *Parameter Conversion* in **Math > Analysis** menu. When you modify the settings in parameter conversion in either **Meas Setup** or **Analysis** sub-menu of **Math**, the modification will be global to parameter conversion in both of the menus.

Correction

For the correction function, refer to descriptions in *Correction/Correction Properties* (click or tap **Calibration > Main** to enter the calibration menu). When you modify the correction state in any function menu, the modification will be global to correction settings in other menus.

Trace Hold

For the trace hold function, refer to descriptions in *Trace Hold* in Trace section (click or tap **Trace** > **Trace Setup** > **Trace Hold**). When you modify the Trace hold function in any function menu, the modification will be global to trace hold settings in other menus.

10 Data Format

The data format is a way of presenting measurement data in the form of graphs. Select the desired data format that matches the test device.

In the **Format** menu, click or tap the desired data format to set the format for the current active trace.

10.1 Rectangular Display Formats

Rectangular display formats (also known as Cartesian coordinates, X/Y, or rectilinear). The rectangular display is especially useful for displaying the frequency response information of the test device.

- **X-axis:** displays stimulus data (frequency, data, or time).
- **Y-axis:** displays measurement data.

Log Mag

Displays the magnitude of the signal, without phase. Y-axis is represented in dB, wrapping a large range of values for easy scaling, convenient to present large variations of the signal. It is applicable to the signal with a large magnitude or large variations as the Log Mag format can better display the details of the signal.

Typical application: used in return loss, insertion loss or gain measurement.

Lin Mag

Y-axis displays positive values of the signal magnitude only, without unit. It is applicable to the calibrated measurement with the Watts (W) or Volt (V) as the unit. For the measurement concerning the power or voltage item, if you have completed the calibration, using this format can directly obtain the magnitude value in linear form.

Typical measurement: reflection and transmission coefficients (magnitude), time domain transfer.

Group Delay

Displays the signal transmission (propagation) time through a device. Y-axis: Time in seconds.

Typical measurement: As the transmission speed of the frequency components of the signal in the medium is different, the time delay occurs, resulting in phase deviation. The phase deviation between various frequency components changes with the frequency, causing signal distortion. If the group delay of a system is a constant value for all the frequency span, it indicates that the system is an all-pass system, meaning

that the transmission speed at all frequencies is the same, which will not cause signal distortion.

Phase

- **Measurement principle:** measures the phase of the signal relative to the calibration reference plane with a range of +/- 180 degrees.
- **Display information:** displays only phase, without magnitude.
- **Y-axis unit:** phase in degrees.
- **Trace characteristics:** When phase values exceed $\pm 180^\circ$, the trace wraps every 180 degrees to facilitate observation and analysis of phase variations within the limited display range.

This prevents large discontinuities in the displayed phase values, easier to observe phase variation and scaling, better for detailed analysis of the phase variation.

- **Typical measurement:** It mainly detects the deviation of the signal from the linear phase, describing the linear variation of the phase along with the time or frequency during system transmission or processing.

Unwrapped phase

Similar with the phase format, but without 180 degrees wrapping. Phase is unwrapped by comparing the phase from one data point to the next. If the phase difference between two points is greater than 180 degrees, or if the phase of the first data point is greater than 180 degrees from DC, then the phase measurement is probably inaccurate.

Positive Phase

Displays the phase wrapped from 0 to +360 degrees. That is, the phase value will not be a negative value. If it exceeds 360 degrees, it will restart from 0 degree.

SWR

Displays reflection measurement data calculated from the formula $(1 + \rho)/(1 - \rho)$, wherein, ρ is reflection coefficient. It's valid only for reflection measurements, used for analyzing the relevant characteristics of the reflection signal. The Y-axis is unitless (U) for ratioed measurements.

Typical measurement: Standing Wave Ratio (SWR) is used to evaluate the match between transmission line and load. It is an important evaluation parameter for impedance match in RF and microwave systems. When $SWR = 1$, it indicates that it is totally matched, which considers as an ideal condition.

Real

Displays only the real (resistive) part of the measured complex data. It can be positive and negative values. The Y-axis is unitless.

Typical measurement: time domain, auxiliary input voltage signal for service purposes.

Imaginary

Displays only the imaginary (reactive) part of the measured data. It can be positive and negative values. Y-axis is unitless.

Typical measurement: impedance for designing matching network.

10.2 Polar

Polar format is used to view the magnitude and phase of the reflection coefficient (Γ) from the S11 or S22 measurement.

You can use markers to display the following information.

- Linear magnitude (in units) or log magnitude (in dB)
- Phase (in degrees)

The distance between the polar trace and the polar origin represents the magnitude (linear) of the measurement results. The position to the origin represents magnitude (linear); the angle deviation from the positive X-axis counterclockwise represents phase.

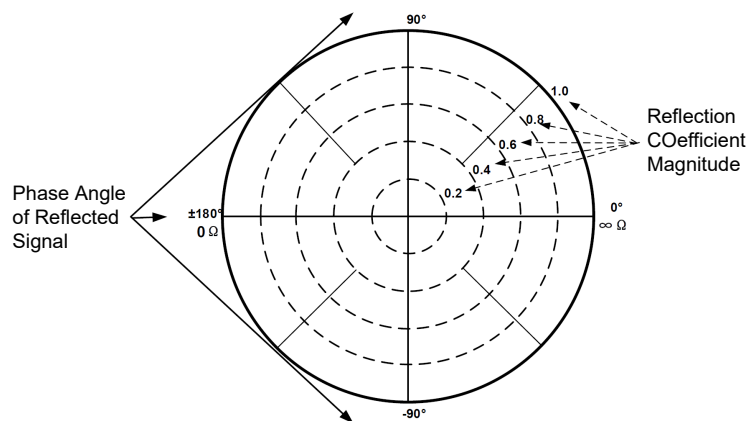

- The dashed circles represent reflection coefficient. The outermost circle represents a reflection coefficient (Γ) of 1, or total reflected signal. The center of the circle represents a reflection coefficient (Γ) of 0, or no reflected signal.

- The radial lines show the phase angle of reflected signal. The right-most position corresponds to zero phase angle, (that is, the reflected signal is at the same phase as the incident signal).
- Phase deviation of 90° , $\pm 180^\circ$, and -90° correspond to the top, left-most, and bottom positions on the polar display, respectively.

10.3 Smith

The Smith chart is a tool used to analyze the impedance and reflection coefficient graphically. In a Smith chart, the rectilinear impedance plane is reshaped to form a circular grid, mapping the complex reflection coefficient (Γ) to the test device's impedance.

With the Smith chart, you can read the series resistance (R) and reactance (X) of the test device, i.e, $(R + jX)$.

- Resistance (expressed in Ω)
- Reactance as an equivalent capacitance (expressed in F) or inductance (expressed in H)

The Smith Chart is widely used in the design, debugging, and troubleshooting of the impedance match in the RF/microwave circuit.

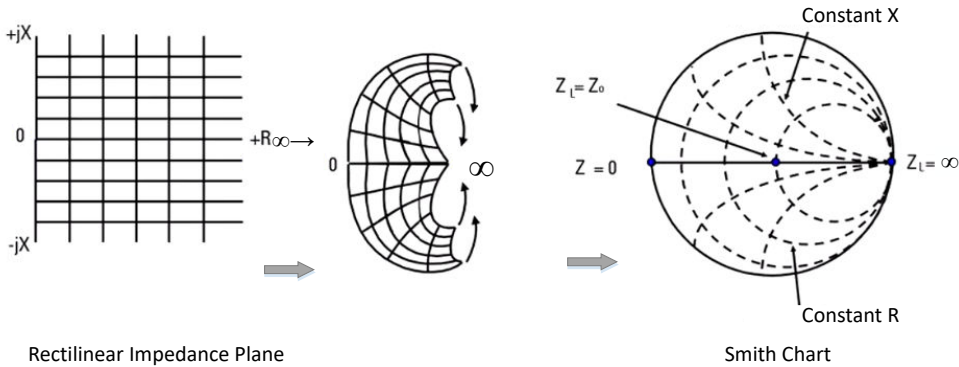

- Every point on the Smith Chart represents a complex impedance made up of a real resistance (R) and an imaginary reactance $(R + jX)$.
- The horizontal axis (the solid line) is the real portion of the impedance - the resistance. The center of the horizontal axis always represents the system impedance. To the far right, the value is infinite ohms (open). To the far left, the value is zero ohms (short).

- The dashed circles that intersect the horizontal axis represent constant resistance.
- The dashed arcs that are tangent to the horizontal axis represent constant reactance.
- The upper half of the Smith chart is the area where the reactive component is positive and therefore inductive.
- The lower half of the Smith chart is the area where the reactive component is Negative and therefore capacitive.

10.4 Inverted Smith

Inverted Smith also known as Admittance, is a tool dedicated for admittance analysis. It is similar with the standard Smith chart, but it analyzes the admittance rather than resistance.

The core principle of the inverted Smith Chart is to convert "impedance analysis" into "admittance analysis", where admittance $Y = G + jB$ (G is conductance, B is susceptance) is the reciprocal of impedance.

- The plot graticule is reversed right-to-left.
- Admittance (in units of siemens) instead of resistance.

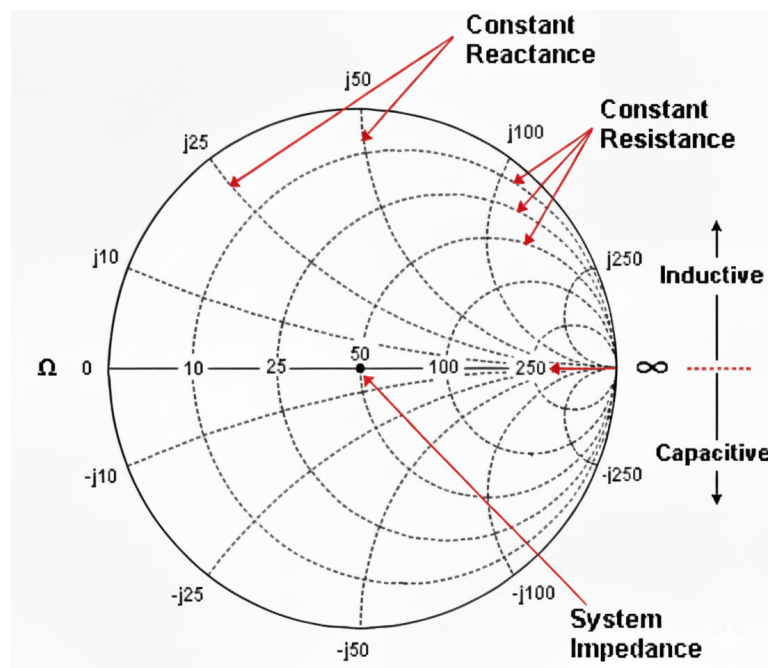

11 Marker

Marker is a triangle sign, which is used for marking the point on the trace. Markers provide readouts of the frequency of each point on the trace and measurement values. The values vary based on the measurement parameters of the trace and the trace format.

11.1 Marker 1-7/Marker 8-15

Up to 15 normal markers (Marker1 to Marker15) and one reference marker are available for each trace. By default, Marker 1 is selected.

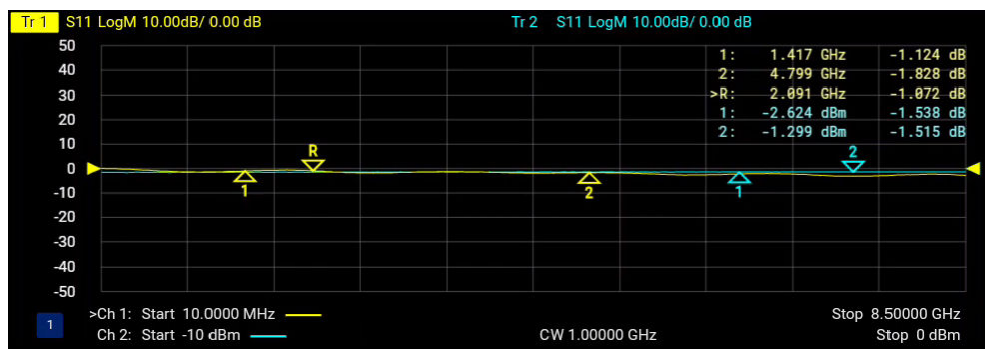

Add/Delete a Marker

Check the checkbox of the specified marker, and the checkbox is highlighted in green, then the marker is added on the trace. Uncheck the checkbox of the specified marker to remove the marker from the screen.

The added marker will automatically become the current active marker. The marker appears above the current trace, displayed as "▽+marker number". All of the other markers inactive on the same trace appear below the trace, displayed as "△+marker number". Click or tap the specified triangle marker icon on the trace in the window to make it become the active marker. You can also click or tap the specified marker from the drop-down list of markers to select it as the active marker.

The marker data are displayed at the right section of the window where the trace is located. One window can display data of up to 20 traces. The marker data contain the following information.

- Marker number. If ">" is added before the marker number, it indicates that the marker is currently active.
- Trace where the marker is located. You can identify the trace by recognizing the color of the marker. The marker color is the same as the trace color.

- Marker's stimulus data (X-axis) and response data (Y-axis). The data format of the marker is the same as that of trace where the marker is located.

Move the Marker

Move the marker with the following methods. During moving, the marker will always move along with the trace. The marker icon can be overlapped with each other.

- Click or tap the selected marker to set its X-axis value with the numeric keypad. Then the marker is moved to the specified position on the trace.
- Click or tap the selected marker to set its X-axis value with the knob. Then the marker is moved to the specified position on the trace.
- Select the marker, then drag the marker to move it to the specified position on the trace. This method is not allowed when the data format of the trace is "Smith", "Inverted Smith", or "Polar".

The marker icon can be overlapped. Move the marker left and right, and the marker will always move along the trace.

Reference Marker

Check the checkbox of "Reference", the checkbox is highlighted in green, then a reference marker is added on the trace. Uncheck the checkbox of "Reference", then the reference marker is removed from the screen.

By default, the reference marker is created at the position where the current normal marker is located, but opposite with each other. If no normal marker is created on the current trace, then the reference marker is created in the central position of the trace, displayed as "R". The reference marker data (marked as ">R") are displayed at the right section of the window where the trace is located. The method on how to move the reference marker is the same as that for the normal marker.

11.2 Marker Setup

Delta

Used to measure the difference between the reference point and a certain point on the trace, including the stimulus delta (X-axis value) and response delta (Y-axis value). By default, Delta is disabled. The delta marker value is displayed at the upper-right corner of the window or displayed in the marker table. The delta marker is displayed as " Δ +marker number".

- If a reference marker already exists for the current trace, when "Delta" is enabled, it calculates the difference between the current active marker and the reference marker. If the reference marker is the current active marker, then the Delta function is disabled.
- If no reference marker exists on the current trace, when "Delta" is enabled, create a reference marker in the center position of the trace, then adjust the positions of the reference marker and the active marker.

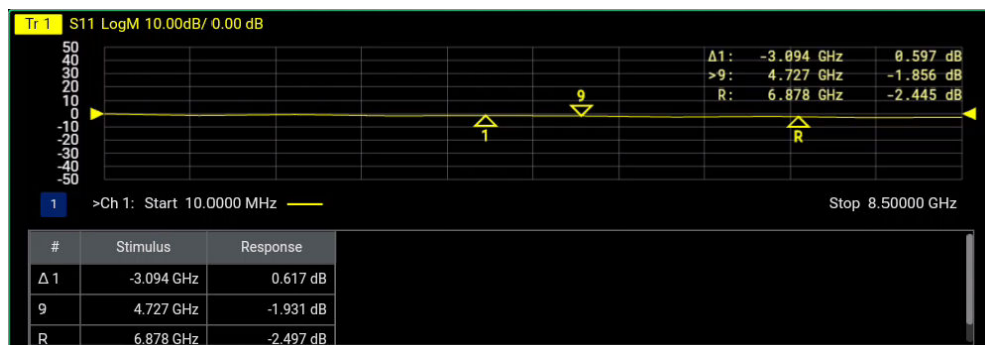

- When you change the position of the Delta marker, the position of the reference marker remains unchanged, but the frequency (or time) difference between the two markers will change along with it.
- The frequency (or Power) difference between the two markers and the measurement values difference Δ are displayed on the screen.

Discrete

Used to display values at only the discrete points where data is measured.

- OFF: By default, it is disabled. The marker readouts of all the data points measured on the trace are displayed.
- ON: Displays values at only the discrete points where data is measured. The marker readouts of data values that are interpolated from the data points will not be displayed. The discrete points where data is measured are determined by *Sweep Points*.

Type

- **Normal:** The marker has a fixed stimulus position (X-axis value), and by default, the response position (Y-axis value) of the marker changes with the trace data.
- **Fixed:** Causes the marker to have a fixed X-axis and Y-axis position based on its placement on the trace when it was set to fixed. It does NOT move with trace data amplitude. It can be scrolled left and right on the X-axis by changing the marker stimulus value.

Format

The newly created marker use the trace data format by default. If you want to modify the data format of the marker, the following formats are available.

Trace Default, Linear Magnitude, Log Magnitude, Phase, Group Delay, Real, Imaginary, SWR, Log/Phase, Lin/Phase, Real/Imag, $R + jX$, and $G + jB$. For details, refer to [Data Format](#).

Coupling Mode

The coupled marker function cause markers on different traces to line up with the markers on the selected trace. When you move the specified marker, all the other markers that are coupled with the marker will be moved together.

Markers are coupled by marker number. If the x-axis domain of different traces is the same (e.g., frequency or power), then coupling occurs to the markers with the same marker number on these traces. Trace markers in a different x-axis domain will not be coupled.

The available coupling modes include:

- **OFF:** disables the marker coupling.
- **Channel:** By default, a marker on one trace is coupled to the same numbered markers on traces which share the same channel number as the original trace.
- **All:** A marker on one trace is coupled to the same numbered markers on all channels, all windows, and all traces.

Marker Table

- **OFF:** By default, it is disabled. The marker table will not be displayed.

- ON: when it is enabled, the marker table displaying all the marker data on the current active trace is displayed below the trace window, including the marker number, stimulus value, and response value.

#	Stimulus	Response
1	1.641 GHz	-0.857 dB
2	2.991 GHz	-1.643 dB
R	5.496 GHz	-2.445 dB

All Off

Click or tap **All Off** to disable the display of all the markers on the current active trace. The coupled markers are also disabled.

11.3 Marker Display

Symbol Above

- OFF: By default, the active marker is displayed above the trace and the non-active marker is displayed below the trace.
- ON: All the marker symbols are displayed above the trace. The active marker is filled solid.

Symbol

Sets the marker symbols. By default, it is Triangle. You can also select "Flag" or "Line".

- "Line" is not available to choose when the data format of the trace is "Smith", "Inverted Smith", or "Polar".
- Symbols can be set independently for each window.

Active Trace Readouts Only

- OFF: By default, all the marker readouts of all the traces are displayed at the upper-right corner of the window.
- ON: When it is enabled, only the marker readouts of the current active traces are displayed at the upper-right corner of the window.

Show Readouts

- ON: By default, the marker readouts of the traces are displayed at the upper-right corner of the window.
- OFF: When it is enabled, marker readouts of the traces will not be displayed in the window.

Readouts Per Trace

Sets the quantity of marker readouts to show in the window for each trace. By default, up to 5 readouts per trace and 20 readouts for each window can be displayed.

11.4 Marker Functions

The marker functions allow you to make stimulus settings with the current active marker. You can make a quick set of the following values.

- **Marker -> Start:**
Sets the position (X-axis) of the current active marker to the start value of the sweep.
- **Marker -> Stop:**
Sets the position (X-axis) of the current active marker to the stop value of the sweep.
- **Marker -> Center:**
Sets the position (X-axis) of the current active marker to the center value of the sweep (middle value between the start value and stop value of the sweep).
- **Marker -> Ref Level:**
Sets the response value (Y-axis) of the current active marker to the *Reference Level* of the current trace.
- **Marker -> Span:** Sets the span between the current active marker and *Reference Marker* to the sweep span. It is unavailable if there is no reference marker.
- **Marker -> Delay:**
The phase slope at the active marker stimulus position is used to adjust the line length to the receiver input. This effectively flattens the phase trace around the active marker.
Additional *Electrical Delay* adjustments are required on devices without constant *Group Delay* over the measured frequency span. This feature adds phase delay

to a variation in phase versus frequency; therefore, it is only applicable for ratioed measurements.

- **Marker -> CW Frequency:** When the X-axis is frequency, set the position of the current active marker to *CW Frequency*. After performing this operation to change the CW frequency, enable *Power Sweep* to apply the modified CW frequency. It is invalid when the current X-axis is not frequency.

12 Search

Performs search on the current active trace based on the set conditions and marks it with the marker. Before using the search function, create a marker for the current active trace, otherwise, some of the search function menus may be grayed out and disabled.

12.1 Main

Max

Click or tap **Max**, then the current active marker moves to the point with the max. measurement value on the current active trace.

Min

Click or tap **Min**, then the current active marker moves to the point with the min. measurement value on the current active trace.

Search Domain

Defines the marker on the trace to search within the specified span. Each marker can be configured with a search domain, and multiple markers can share one search domain.

Click or tap the drop-down button of **Search Domain** to select the specified span.

- **Full Span:** By default, it is full span. That is the whole X-axis, which is the same as the sweep range of the trace itself.
- **User 1 to User 16:** searches within the user-defined span. The X-axis of the marker is defined within the set search domain.

At most, 16 user-defined search domains can be set. You need to set Domain Start and Domain Stop for each user-defined search domain. Each user-defined domain is independent of each other, and the user-defined domains can overlap with each other. When the search domain is set to the user-defined domain other than "Full Span", a pair of smaller triangles appear automatically in the X-axis to identify the search domain of the current active marker.

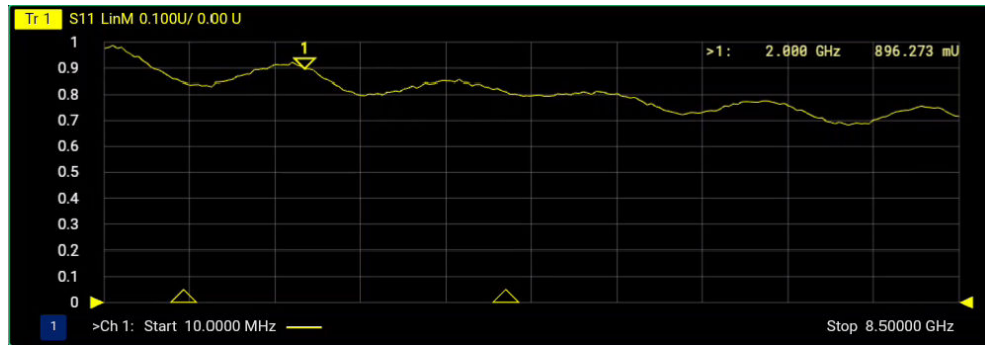

Tracking

When you set the tracking condition, the VNA device will perform the search operation based on the current search conditions and search domain. Once the target point is found, the marker will locate it immediately. The marker position will move along with the update of the trace data.

Click or tap the drop-down button of **Tracking** to set the tracking conditions for the current active marker. The tracking conditions include:

- **Off:** By default, tracking function is disabled.
- **Max:** The marker moves to the maximum response data value (Y-axis value) within the search domain.
- **Max:** The marker moves to the minimum response data value (Y-axis value) within the search domain.
- **Peak:** Related to the peak search type. For details, refer to [Peak](#).
- **Target:** Related to the target search type. For details, refer to [Target](#).
- **Multi Peak:** The marker moves to the multi-peak search result position on the trace based on the search domain. For details, refer to [Multi Peak & Target](#).
- **Multi Target:** The marker moves to the multi-target search result position on the trace based on the search domain. For details, refer to [Multi Peak & Target](#).



NOTE

- For different markers on the same trace, they can be set to Max, Min, Peak, and Target tracking. If they are set to Multi Peak or Multi Target tracking, then other tracking settings are invalid. all the markers share the same tracking.
- The markers that have enabled the tracking function will not affected by marker coupling.

12.2 Peak

In the **Search** menu, click or tap **Peak** to enter the peak search setting sub-menu. Before executing the peak search, set the search condition and search type first.

Peak Right Search/Peak Left Search

- Click or tap **Peak Left Search** to search for the nearest peak which is located at the left side of the current peak and meets the peak search condition.
- Click or tap **Peak Right Search** to search for the nearest peak which is located at the right side of the current peak and meets the peak search condition.

Next Peak Search

Click or tap **Next Peak Search** to search for the peak whose amplitude on the trace is next to that of the current peak and meets the peak search condition. Once found, the current active marker will move to the position and marks it.

Peak Polarity

- Positive (default): searches for the positive peak, which refers to a peak whose measured value is greater than those of the measurement points on either side of it.
- Negative: searches for the negative peak, which refers to a peak whose measured value is smaller than those of the measurement points on either side of it.
- Both: A peak whose measured value is smaller and greater than those of the measurement points on either side of it. Both the positive peak and negative peak are considered as valid peaks.

Peak Threshold

Related to the "Peak Polarity" setting.

- For the positive peak (positive polarity), only the peaks whose measured values are greater than threshold can be considered as valid.
- For the negative peak (negative polarity), only the peaks whose measured values are smaller than threshold can be considered as valid.

- When the peak polarity is set to Both, the threshold value is not used to judge the valid peak.

Peak Excursion

The peak excursion is the difference between the peak measured value and the measured value of the adjacent peak of the opposite polarity. Only the peaks whose peak excursion value is greater than the set peak value can be considered as valid.

Tracking

For the tracking function, refer to descriptions about tracking function specified in *Main* section.

Peak Search

First set the search conditions for the valid peak, then click or tap **Peak Search** to perform the peak search. Once the valid peak is found on the trace, the current active marker will move to the position and marks it. When no peak meets the specified peak search condition is found, the position of the marker remains unchanged.

12.3 Target

The target search function searches for a target that matches the pre-defined target value and transition types (positive, negative, or both) and then moves the marker to that target.

In the **Search** menu, click or tap **Target** to enter target search setting sub-menu. Before executing the target search, set the search condition and search type first.

Target Right/Left Search

- Target Right Search: The marker moves to the next valid target to the right of the first target encountered.
- Target Left Search: The marker moves to the next valid target to the left of the first target encountered.

Target Value

The target value refers to the searched response value (Y-axis value). If the response value of a certain point on the trace equals the target value, then the data point is the target point to be searched for.

Target Transition

- **Positive:** The measured value at the right side of the target point is greater than that at the left side of the target point.
- **Negative:** The measured value at the right side of the target point is smaller than that at the left side of the target point.
- **Both:** Both the positive and negative transition types are considered as valid target. It is the default target transition.

Tracking

For the tracking function, refer to descriptions about tracking function specified in [Main](#).

Target Search

After configuring the target value, target transition, and search domain, click or tap **Target Search** to perform the target search. Once the target point is found on the trace, the current active marker will move to the position and marks it.

12.4 Multi Peak & Target

Multi Peak Search

The multi peak search function enables you to display markers on multiple peaks on traces based on the multi peak excursion and multi peak polarity settings. Before executing the multi peak search, set the following parameters to define a valid peak.

- **Multi Peak Threshold:** Minimum amplitude (in dB). To be considered valid, the peak must be above the threshold level. The valley on either side can be below the threshold level.
- **Multi Peak Excursion:** The vertical distance (in dB) between the peak and the valleys on both sides. To be considered a peak, data values must "fall off" from the peak on both sides by the excursion value.
- **Multi Peak Polarity:** Positive, negative, and both. For details, refer to [Peak Polarity](#) in Peak Search section.

After configuring the above parameters, click or tap **Multi Peak** to start searching from the start position of the search domain to the right to search out all the valid peaks and marks them with the marker.

Up to 16 markers (15 normal markers and 1 reference marker) can be displayed on a trace. When the number of valid peaks exceeds 16, only the first 16 valid peaks can be searched to be displayed.

Multi Target Search

The multi target function searches for a target that matches the pre-defined multi target value and multi target transition. Before executing the multi target search, set the following parameters.

- **Multi Target Value:** sets the response value (Y-axis value) of the search target. The data format and unit of the target value are the same as that of the current trace.
- **Multi Target Transition:** Positive, negative, and both. For details, refer to *Target Transition* in Target Search section.

After configuring the above parameters, click or tap **Multi Target** to start searching from the start position of the search domain to the right to search out all the valid targets and marks them with the marker.

Up to 16 markers (15 normal markers and 1 reference marker) can be displayed on a trace. When the number of valid targets exceeds 16, only the first 16 valid targets can be searched to be displayed.

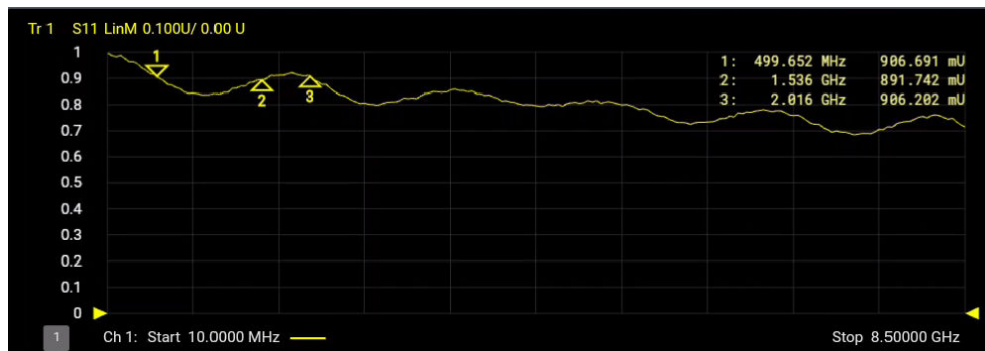

Tracking

The tracking function causes the marker to search for the specified search condition with each new sweep. By default, it is OFF.

When the tracking function is enabled, the search begins with the first sweep based on the current search type and domain information. Therefore, before using the data, ensure that the search condition is in the desired state. If tracking is selected for a marker, you are not allowed to manually modify the stimulus settings for the marker.

13 Calibration

In the vector network analysis, the test system (including the DUT, cable, connector, fixture, and etc.) inevitably may bring about system errors, resulting in the fact that the raw measurement value of the DUT cannot directly represent its true characteristics. Therefore, the VNA is equipped with a series of calibration features such as calibration compensation, fixture simulation, and port extension, to remove the identified errors from the measurement results accurately.

VNA provides a series of calibration solutions to address different application scenarios.

- The calibration compensation is mainly used to remove the inherent basic errors in the test system, which is the basis for achieving high-precision measurement.
- The fixture de-embedding function is intended to remove the effects of the test fixture on the measurement effectively and restore the true performance of the DUT.
- The port extension feature is applicable in compensating the amplitude offset and phase deviation caused by the length of the test cable to ensure the accuracy of the measurement.

The above features are designed for different test demands, but the core principle is to correct errors through S-parameters matrix and error compensation matrix operation, mathematically compensating the system errors in the transmission path of the measurement signal fundamentally.

Note that when multiple correction functions are enabled simultaneously, the execution sequence of the specified function will directly affect the validity of the final measurement results. Ensure that the sequence of the physical connection of the DUT, the expected test network model setup and function execution are consistent. Only in this way, can the measured data truly reflect the characteristics of the DUT.

13.1 Main

The following table lists the S-parameter calibration type supported by VNA.

Table 13.1 S-parameter Calibration Type Supported by VNA

Number of Ports	Calibration Type	Calibration Item to be Performed
1	Response Open	Open response calibration

Number of Ports	Calibration Type	Calibration Item to be Performed
(Only calibrate the reflection parameters)	Response Short	Short response calibration
	OSL	Open, Short, and Load response calibration
2	Response 1 to 2	Port 1→2 Through response calibration
	Response 2 to 1	Port 2→1 Through response calibration
	Enh Response 1 to 2	Enhanced response calibration <ul style="list-style-type: none"> Port 1: Open, Short, and Load Port 1→2: Through
	Enh Response 2 to 1	Enhanced response calibration <ul style="list-style-type: none"> Port 2: Open, Short, and Load Port 2→1: Through
	SOLT	All response calibration <ul style="list-style-type: none"> Port 1: Open, Short, and Load Port 2: Open, Short, and Load Port 1↔2: Through

13.1.1 Basic Calibration

In the calibration wizard, select the desired S-parameter calibration type and configure the relevant parameter settings to perform the S-parameter user-defined calibration.

Click or tap **Basic Cal** to enter the basic calibration interface.

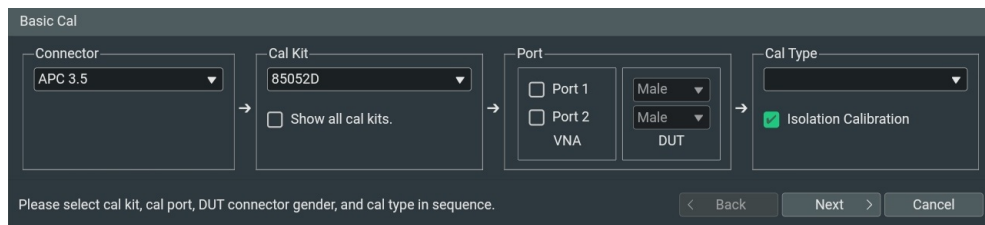

- **Connector**

Selects the desired connector type from the drop-down list to select APC 3.5, APC 2.4, APC 7, 7-16, Type F(75), Type N(75), or Type N(50).

- **Cal Kit**

Selects the desired calibration kit model from the drop-down list based on the currently selected connector.

If you check the checkbox of "Show all cal kits", then all of the calibration kits are available to choose without being limited to the connector type.

- **Port**

Check the checkbox of the specified port number to be calibrated, then select the port type (Male or Female) of the DUT that connects the specified port. You can select one or two ports (Port 1 and Port 2) to calibrate.

- **Cal Type**

Selects the desired calibration type from the drop-down list based on the currently selected port. For details, refer to [Table 13.1 S-parameter Calibration Type Supported by VNA](#).

After completing the above configuration, click or tap **Next** to enter the following interface. If you haven't set the parameters well, you can click or tap **Back** to go to the previous step to configure the parameters.

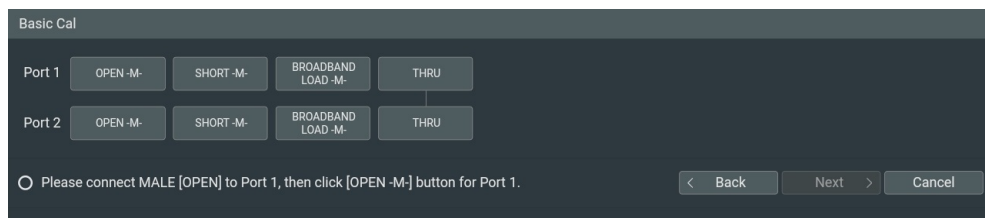

In the menu, you can view the currently selected port to be calibrated and the calibration items to be performed on the specified port. The calibration items include OPEN-M- (Open calibration measurement), SHORT-M- (Short calibration measurement), BROADBAND LOAD-M- (Load calibration measurement), and THRU (Through calibration measurement). Follow the procedures below to perform the basic calibration.

1. Connect the calibration kits to the test ports of VNA properly according to the pop-up messages.
2. Click or tap the first calibration button, then the current calibration trace window is displayed below the window. When "✓" (a tick icon) is displayed on the button, it indicates that this calibration item is completed.
3. Repeat Step 1 and Step 2 until all the selected calibration items have been calibrated successfully. The menu state shows below.

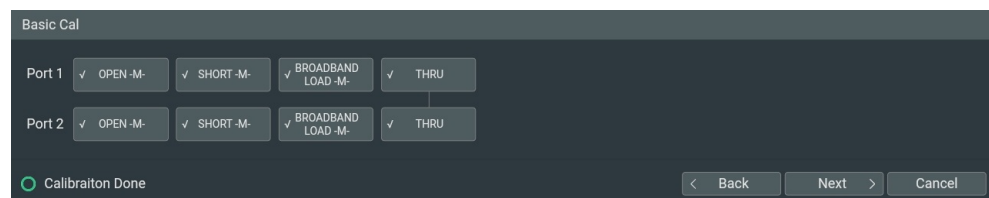

Click or tap **Save As** to enter the file management interface ([File Management](#)). The calibration configuration information of the current channel is saved to the specified path as a file suffixed with "*.cal". Click or tap **Finish** to complete this

calibration, and you will exit from the current interface and go back to the main interface of "Basic Cal". To cancel the calibration, click or tap **Cancel**.

- To perform the Isolation Calibration, click or tap **Next** to enter the isolation calibration interface, as shown below.

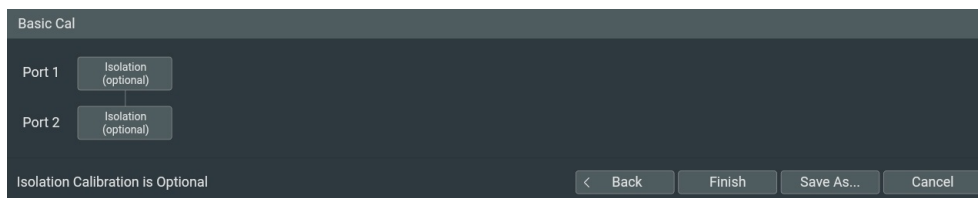

Click or tap all the isolation calibration buttons to perform calibration. After completing the calibration, the calibration configuration file is saved to the specified path, with the filename suffixed with "*.cal". Click or tap **Finish** to complete the calibration.

13.1.2 Electronic Calibration

ECal is a solid-state calibration solution. Every ECal module contains electronic standards that are automatically switched into position during a measurement calibration. These electronic standards have been measured at the factory and the data are stored within the memory of the ECal module. The VNA analyzer uses the stored data, along with the measured data, to calculate the error terms for a measurement calibration.

For the Ecal modules supported by VNA, refer to [Appendix A: Options and Accessories](#). For more information about Ecal, its operation and connection methods, refer to *ECal User Guide*.

Connect the ECal module port to the port of the analyzer. The Ecal module is controlled and powered through a USB connection. Wear a grounded wrist strap when making ECal calibration. Do not disconnect USB devices and test port during ECal calibration. After connecting the ECal module properly, wait for completing warm-up until the indicator turns green, then start to calibrate.

The procedures for calibration operation are as follows:

- Click or tap **ECal** to enter the "Select Calibration Ports and ECal Module" interface. Set the following configuration.

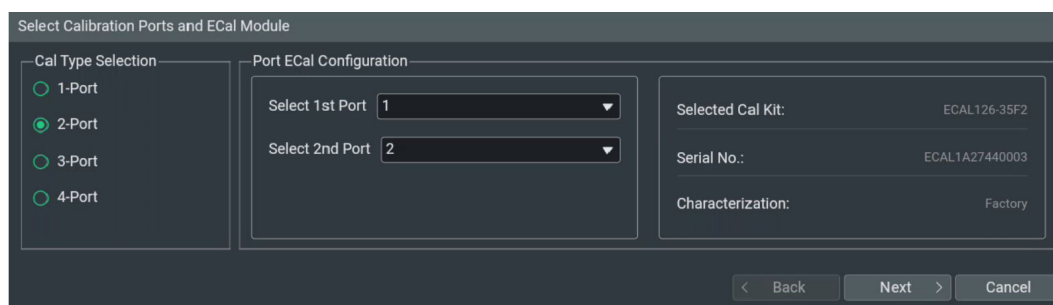

- **Select the calibration type**

Supports single port calibration or multiple ports (e.g. 2-Port) calibration. You can select the desired port based on your DUT.

- **Port Ecal configuration**

Selects the desired calibration port based on the calibration type. For 2-port calibration, you must select two different ports.

- **Ecal properties**

After connecting properly, VNA can automatically recognize the ECal module and obtain the module information.

2. Click or tap **Next** to enter the following interface.

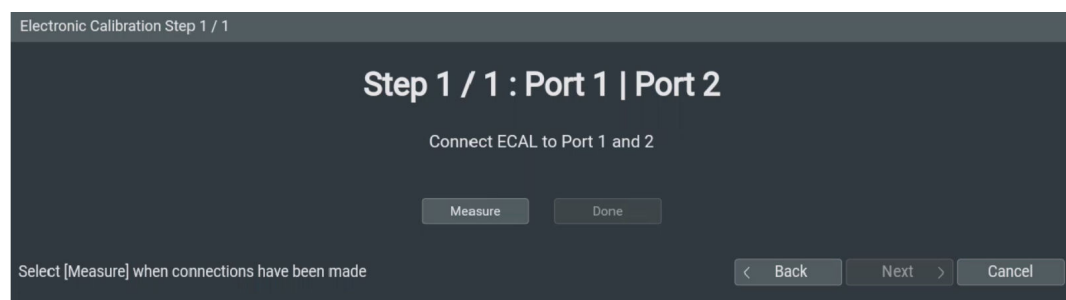

Complete the calibration operation according to the calibration wizard.

3. After completing the measurement, the following interface is displayed. Click or tap **Save As** to save the calibration configuration file suffixed with "*.cal" to the specified path. Click or tap **Finish** to complete the calibration.

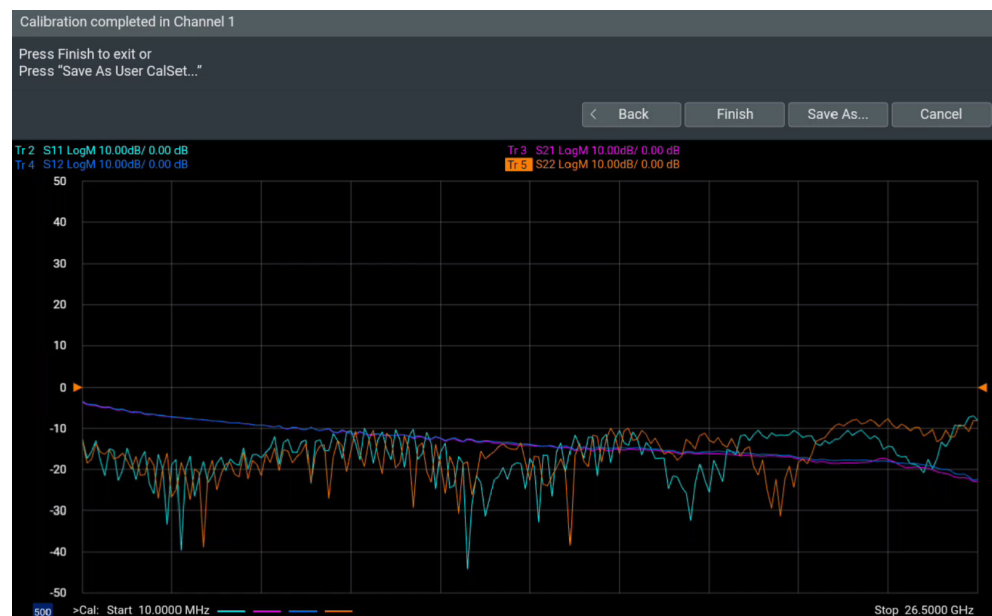

13.1.3 Correction/Correction Properties

By default, the correction function is disabled. After completing the calibration or loading the calibration files successfully, correction is performed automatically, and its state turns out to be ON. If the instrument is not calibrated, correction cannot be enabled.

If the instrument has not been corrected, "No Correction" displays in *System Status Bar* below the window. After being corrected, it displays the correction state. The following table lists the detailed information of correction state.

Number of Ports	Calibration Type	Correction State
1	OSL	C 1-Port
	Response Open Response Short	C Resp
2	Response 1 to 2 Response 2 to 1	
	Enh Response 1 to 2 Enh Response 2 to 1	
	SOLT	C 2-Port

The following table lists the correction level and accuracy for different correction state.

Table 13.3 Correction Level

Correction State	Description	Accuracy
C N-Port	N indicates the number of fully calibrated ports.	Highest
C Enh Resp	Indicates the enhanced response calibration. It is an aggregate of a 1-port calibration and a transmission response calibration.	Second Highest
C Resp	Open or Short circuit response calibration It indicates correction for the frequency response of the measurement. It does not correct for impedance mismatches.	Second Lowest
No Correction	Indicates that the correction is disabled.	Lowest

Correction State	Description	Accuracy
C*	Interpolated correction. For details, refer to <i>Interpolation</i> .	Uncertain
CA	Changed correction. For details, refer to <i>Interpolation</i> .	Uncertain

Correction Properties

After completing the correction, click or tap **Correction Properties** to view the correction related information. If the instrument has not been calibrated, this menu is grayed out and disabled.

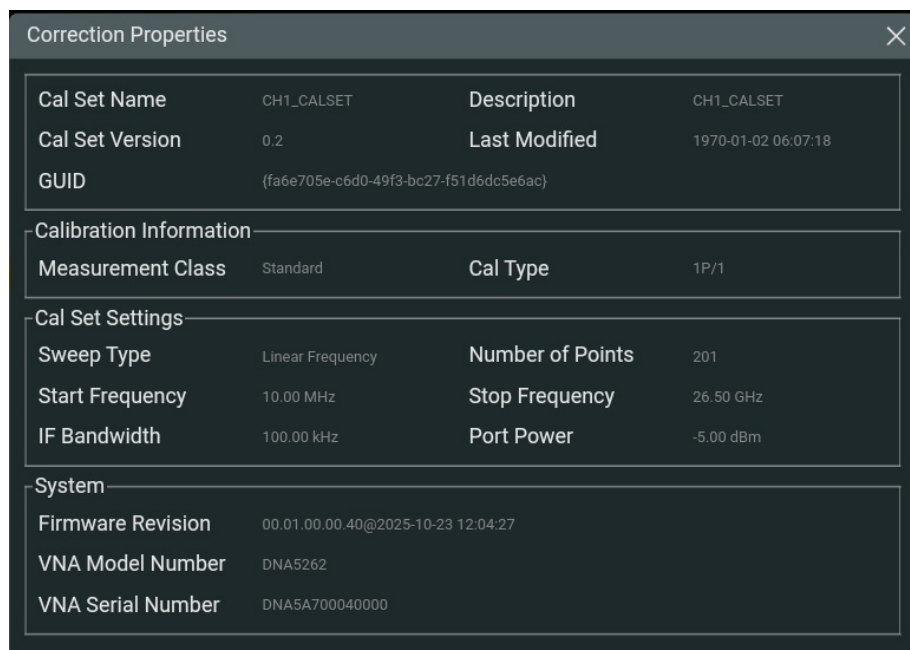

13.1.4 Calibration Kits

Click or tap **Cal Kit** to enter the "Manage Cal Kits" interface, as shown in the figure below.

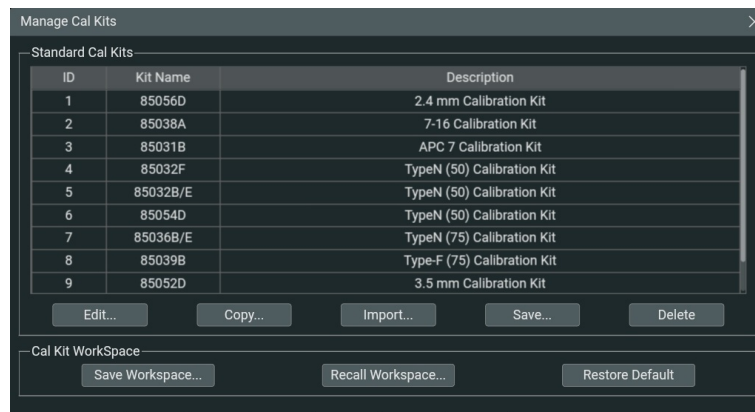

There are multiple built-in calibration kits in the VNA.

Edit the Calibration Kits

Modifies the parameters for each calibration kit. Select one calibration kit, then click or tap **Edit...** to enter the calibration kits editing interface, as shown in the figure below.

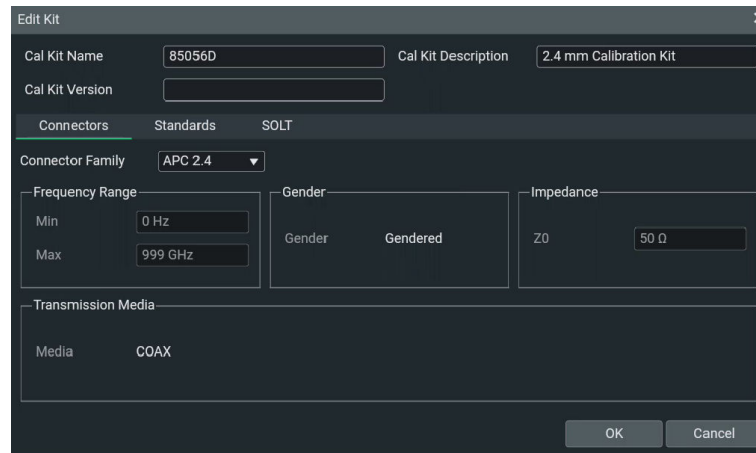

Modify the parameters according to your needs. After completing editing, click or tap **OK** to save the editing. Then exit the parameter setting interface automatically.

Basic Operations

- **Copy:** Select one calibration kit, then click or tap **Copy...**, then the calibration kits copying interface is displayed. Modify the parameters according to your needs. After completing editing, click or tap **OK** to copy the specified calibration kit to the calibration kits list. Then exit the calibration kits copying interface automatically. The newly copied calibration kit is added to the calibration kits list, with the default filename "original calibration kit name_N". Wherein, N indicates the number. By default, for the first copy version of the specified calibration kit, N is 1, it increases with an increment of 1.
- **Import:** Click or tap **Import...**, then the file management interface (*File Management*) is displayed. Select the file suffixed with "*.xkt" from the specified path. Click or tap **Confirm** to import the specified file from the specified path. You can import the user-defined calibration kit to the current calibration kit list. It is displayed at the last line of the current calibration kit list. Then you can use the user-defined calibration kit to calibrate the VNA.

- **Save:** Select one calibration kit, then click or tap **Save...** to enter the file management interface. Save the current calibration kit and its detailed parameter settings to the specified path, with the filename suffixed with "*.xkt".
- **Delete:** Select one calibration kit, then click or tap **Delete**, then a prompt message prompting you whether to delete the specified calibration kit is displayed. Click or tap **Confirm** to delete the specified calibration kit from the current calibration kits list.

Calibration Kit Workspace

In the "Manage Cal Kits" interface, the displayed "Standard Cal Kits" list is defined as one workspace.

- **Save Workspace:** Click or tap **Save Workspace...** to enter the file management interface. All of the calibration kits and the detailed parameters information of each calibration kit in the current workspace are saved to the specified path, with the filename suffixed with "*.xkw".
- **Recall Workspace:** Click or tap **Recall Workspace...** to enter the file management interface. Select the specified file suffixed with "*.xkw" from the specified path. Click or tap **Confirm** to recall the user-defined calibration kit list in replace of the current workspace. Then you can use the specified calibration kit in the user-defined workspace to calibrate the VNA.
- **Restore Default:** Click or tap this button to restore the calibration kits list and detailed parameters of each calibration kit to the default settings.

13.1.5 To Save or Recall the CalSet File

After completing the calibration, all the calibration data will be saved to the calibration sets. The calibration sets can be applied to the channels that have the same stimulus settings as this calibration set, thus reducing the time for performing the calibration again. The data saved in the calibration sets include ID and description, calibration set properties (stimulus setting, calibration type, port association, etc.), calibration data, error term data, GUID, etc.

After completing one calibration, the data will be saved to the calibration register of the specified channel automatically, overwriting the existing calibration data in the

register. You can save it to the specified path as a calibration sets file suffixed with "*.cal".

The saving and recalling operation of the calibration sets file can be performed in the file management interface. For details, refer to [File](#).

Save CalSet

Click or tap **Save CalSet**, then the file management interface is displayed. In the interface, set the saving path, filename, the file format "*.cal", then click or tap **Save** to save the file.

Recall CalSet

Click or tap **Recall CalSet**, then the file management interface is displayed. Open the specified path and select the specified calibration sets file suffixed with "*.cal", then click or tap **Confirm** to complete loading the file.

13.1.6 Interpolation

Calibration interpolation adjusts calibration error terms to match changes to the stimulus parameters settings (such as freq and points) that you make after a calibration is performed or a CalSet is applied, keeping the accuracy of the measurement results through the interpolation algorithm, avoiding error calibration failure arising from modifying the settings.

Enable or Disable the Interpolation

By default, interpolation is disabled. When enabled, the interpolation is enabled for the current active measurement, but this does not necessarily mean that the measurement is interpolated. When enabled, if you modify the following stimulus settings, and the system deems that it is necessary to initiate interpolation operation to keep the accuracy of the measurement, then the interpolation will be applied. If you modify the stimulus settings while the interpolation is disabled, then interpolation is not applied, but the error correction function ([Correction/Correction Properties](#)) is automatically disabled.

Interpolation occurs (if enabled) if you change the following settings in [Sweep](#).

- Start frequency increased
- Stop frequency decreased
- Number of points adjusted



TIP

Decreasing the start frequency or increasing the stop frequency will force the correction function to be disabled.

Interpolation Calibration Accuracy

When a measurement is interpolated, the accuracy of the measurements cannot be predicted. It may be affected significantly or not at all. Identifying measurement errors in these cases must be determined on a case-by-case basis.

- In general, the magnitude and phase stimulus from the VNA and the response from the DUT need to be smooth and continuous for measurement interpolation to give accurate results.
- Significant measurement inaccuracy occurs when the phase shift response variation between measurement points changes more than 180 degrees.
- In general, the chances of significant inaccuracy increases when interpolating measurements under the following conditions:
 - When the frequency span between measurement points becomes greater
 - When the measurement frequencies are above 10 GHz where the phase changes happen more rapidly
 - When interpolating across frequency band crossings

When the interpolation algorithm encounters an abrupt or large change in the response magnitude or phase, such as can occur at band crossings, large interpolation errors can be included in the displayed data. These errors can be seen as steps or spikes. If this occurs, attempt to use the following methods to avoid it.

- Disable interpolation
- Adjust the sweep measurement parameters such as decreasing the frequency span, decreasing the sweep points, etc.
- Create sweep segments that skip over the band crossings

Display State of Interpolation Calibration

After executing the interpolation correction, the calibration status displayed in *System Status Bar* below the window changes. The character C following a star "*" appears. For example, "C* 2-Port".

- **Interpolation Correction:**

If you modify the *Sweep* points, increase the start frequency or decrease the stop frequency, the interpolation correction is enabled, then the correction state displayed in *System Status Bar* below the window shows "C*", for example, "C* 2-Port".

- **Configuration Modification:**

If one or multiple stimulus parameters such as *IF BW*, *Sweep Time*, or *Port Power* change, the correction status shows "CA". For example, "CA 2-Port".

13.2 Port Extension

Port extensions allow you to electrically move the measurement reference plane after you have performed a calibration. After completing the S-parameter calibration, use the port extension to address the following problems in the test scenarios.

- **Test fixture limitation:** The device is in the test fixture, making you unable to perform a calibration directly on the device. Perform a calibration at a convenient place, then use the port extension function to compensate for the time delay (phase shift) and loss caused by the fixture.
- **Additional transmission line:** If you have performed a calibration, and then you decide to add a length of transmission line in the measurement configuration, then you can use the port extension configuration to extend the length to the specified port of the VNA.

Click or tap **Calibration** > **Port Extension** > **Port Extensions** to enter the Port Extensions interface.

Configure the port extensions parameters

- **Port 1/2:** Selects the measurement port to be used. The settings of the port extension will affect all measurements on the active channel that are associated with the specified port.

- **Enable or disable the port extension:** Check or uncheck the checkbox of **Port Extension ON** to enable or disable the port extension function.
- **Delay**

Time: indicates the amount of port extension delay in time. Enter a positive or negative value.

Dist.: indicates the amount of port extension delay in physical length. Enter a positive or negative value.

Distance Unit: indicates the available distance units, such as Meters, Feet, and Inches.
- **Loss**
 - **Loss at DC:** Offsets the entire frequency by this value. It is used to compensate for the loss at DC caused by the transmission line and test fixture. To compensate for loss at DC, enter a positive value which causes the trace to shift in the positive (up) direction.
 - **Loss1@Freq1:** the loss and frequency parameters are used together. After checking the checkbox of "Loss1", input a specific loss value in dB, and specify a frequency value in Hz. Set a loss reference value at the specified frequency point to make the calibration more accurate in the loss at the specified frequency range.
 - **Loss2@Freq2:** Similar with the setting of Loss1@Freq1. Input a specific loss value in dB and specify a frequency value in Hz.

When "Loss1" and "Loss2" are used, a curved-fit algorithm is used to calculate the loss compensation of other points within the frequency range to accurately calibrate the loss across the entire frequency range.
- **Velocity Factor:**

For each port, set the velocity factor that applies to the medium of the device that was inserted after the measurement calibration. For details, refer to descriptions about velocity factor in *Electrical Delay*. By default, the velocity factor is set for only the specified port and only for port extension. After checking the checkbox of **Couple to System Velocity Factor** following **Velocity Factor**, the velocity factor is set for all ports.

Once the checkbox of **Couple to System Velocity Factor** is checked, modifying the velocity factor value will also change the velocity factor in *Electrical Delay*, *DTF (Option)*, and *Time Domain Setup (TDA Option)*.

Procedures for performing port extension

1. Select a calibrated S11 measurement trace. Take reflection coefficient of Port 1 as the basic measurement.
2. Set the data format of the measurement trace to "Phase" to better observe and adjust the phase.
3. Connect Open or Short at the calibration reference plane. View and verify the phase readouts across the frequency range. In the ideal state, the phase shall be at or near zero. If the phase deviation is large, check whether there is a problem in the calibration process or hardware connection.
4. Connect the fixture or added transmission line to the measurement system in place of the DUT. In the position where DUT is located, attach an Open or Short.
5. Adjust the delay compensation
 - If the fixture or the "electrical length" of additional transmission line is known, set the "Delay" parameter directly.
 - If the fixture or the "physical length" of additional transmission line is known, set the "Distance" parameter directly.
 - If the extension length is unknown, increase the value of "Delay" or "Distance" gradually to observe the phase response within the frequency span shown on the screen. Adjust the value continuously until the phase response within the specified frequency span becomes smooth, that is, ensure that the phase variation is within the acceptable range. Then complete the port extension operation.

After performing the above operations, observe whether the phase, reflection coefficient, and other parameters at different frequency points meet the expected values. Compare the results with the results that have not performed port extension to confirm whether the setting is valid. If the measurement results are not ideal, repeat the above steps and readjust the relevant parameters.

13.3 Fixture

The fixture is used to simulate the electrical characteristics of the fixture with the software-based math model. With the S-parameter (scattering parameters) of the test

fixture or the calculated S-parameter based on the physical structure and material parameters of the fixture, you can build the math models. When measuring the DUT, the measured data obtained by the VNA contain the comprehensive characteristics of the DUT and the fixture. The fixture feature applies the established fixture math model to the measured data and removes the effects of the fixture from the measurement results through math operation to obtain the true characteristics of the DUT.

The fixture is commonly used in the testing of semiconductor and other miniature or special encapsulated components, high-precision batch measurements of RF components, and high-frequency signal path compensation in the high-speed interconnected testing.

Fixture Functions

- **Eliminate the effects of the fixture:** Through math models, the fixture eliminates the errors from the measurement results, such as loss, reflection, and phase deviation caused by the fixture, to obtain more accurate DUT characteristics data.
- **Circuit embedding and de-embedding:** Adds (embed) or removes (de-embed) the specified circuit to, or from the measurement.
- **Port Z conversion (port reference impedance conversion):** Enables the measurement to be carried out under different impedance standards to meet different test demands.

Test Notice

When using the fixture, avoid the error caused by the fixture to ensure the accuracy of the calibration results.

- 1. Keep the fixture model parameters accurate:** Deviations of the input S-parameters of the fixture may lead to the distortion of the compensated results.
- 2. Keep the consistency between the fixture and the models:** In the batch measurement, if the fixture is replaced, you need to re-measure or adjust the fixture model parameters, rather than using the original model to perform the measurement.
- 3. Keep the frequency band matched:** Keep the effective frequency band of the fixture model to cover the working frequency band of the DUT.

- 4. Basic calibration not negligible:** The fixture simulator is a compensation tool superimposed on the basic calibration, but it cannot replace the basic calibration (e.g. SOLT calibration) of the analyzer. Thus, basic calibration is still necessary.

13.3.1 Port Match

The port match feature is used to embed the specific circuit model into the measurement results, simulating the impedance characteristics of the fixture at the VNA port, thus reflecting the performance of the DUT in the actual working environment accurately.

Click or tap **Port Match** to enter the following interface.

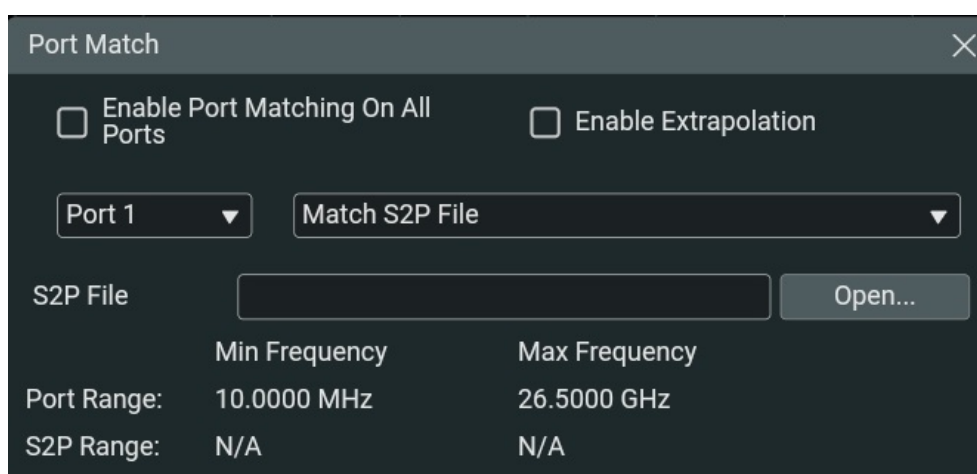

1. Check the checkbox of **Enable Port Matching on All Ports** to enable the port matching function.
2. Click or tap the drop-down button to select the desired VNA port to be matched.
3. Click or tap to select "None" or "Match S2P File" from the drop-down list. When "Match S2P File" is selected, you can select the path where to load the "*.S2P" file.

Click or tap **Open** to enter the file management interface (*File Management*), select the desired "*.S2P" file to be loaded, then click or tap **Confirm** to complete loading.

The "*.S2P" file is the S-parameter file of 2-port network, which is used to simulate the representation of component model of the fixture in the actual test circuit.

4. When the frequency range of the loaded S2P file does not match the current measurement range, you can check the checkbox of **Enable Extrapolation**, the system will extend the values for the first and last data points in either direction through algorithm to make it cover the frequency range of the current measurement, ensuring the port match function works normally.

13.3.2 Port Z

The default reference impedance of VNA is 50 Ω , and the characteristics impedance of the actual DUT may have a variation from the default value, e.g. $Z_0 = 25\Omega/75\Omega/100\Omega$. The port impedance conversion function converts the default reference impedance into the actual characteristics impedance of the DUT through the built-in math modeling algorithm; or converts the performance data under the non-default impedance to the system default impedance's equivalence, ensuring that the actual electrical performance of the DUT can be accurately obtained under different impedance standards.

Process of port impedance conversion:

1. Acquire raw data: Take the system default impedance 50 Ω as the base reference to measure the DUT's raw S-parameters.
2. Configure the target impedance: Set the actual characteristics impedance of the DUT, that is, target impedance.

The target impedance is configured based on the DUT characteristics settings. The key parameters are as follows:

Parameter	Definition	Application Scenarios
Real	Resistance component	DUT is the pure inductive component, and only real part is required to be configured, and the imaginary part is by default 0.
Imaginary	Reactance component	The DUT contains parasitic capacitance or inductance, and it is necessary to configure the imaginary part. Otherwise, the measurement deviation will increase significantly.

3. Data conversion operation: Convert the raw data into the equivalent S-parameter under the target impedance to output the accurate measurement results.

The Port Z configuration interface is displayed in the following figure.

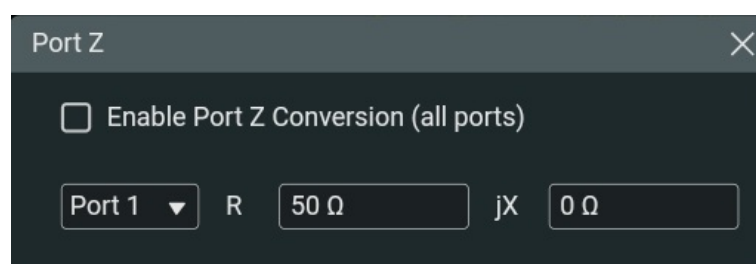

1. Check the checkbox of "Enable Port Z Conversion (all ports)" to enable the port Z. You should also enable de-embedding. The converted impedance value is only applicable to all the measurement trace of the current active channel.
2. Click or tap the drop-down button to select the desired VNA port (Port 1/Port 2) to be applied to impedance conversion.
3. Set the target impedance parameters: real part (R) and imaginary part (jX).

13.3.3 2-port DeEmbed

2-port DeEmbed feature is used to optimize the VNA measurement results. After calibration, if a 2-port fixture (e.g. Adapter, attenuator, a long length of cables) is added in the measurement system, they will affect the measurement results if they are connected between the calibration reference plane and the DUT, unable to measure the DUT accurately. The 2-port DeEmbed feature can remove the effects of the 2-port fixture from the measurement results and restore the true performance of the DUT.

The de-embed operation recalls a "*.S2P" file in Touchstone format. This file contains the electrical characteristics of a 2-port fixture or component, such as impedance and phase. By analyzing and calculating the data in this file, in combination with the measured data, the de-embedding feature can eliminate the effects of the fixture on the measurement results.

Click or tap **2-port DeEmbed** to enter the following interface.

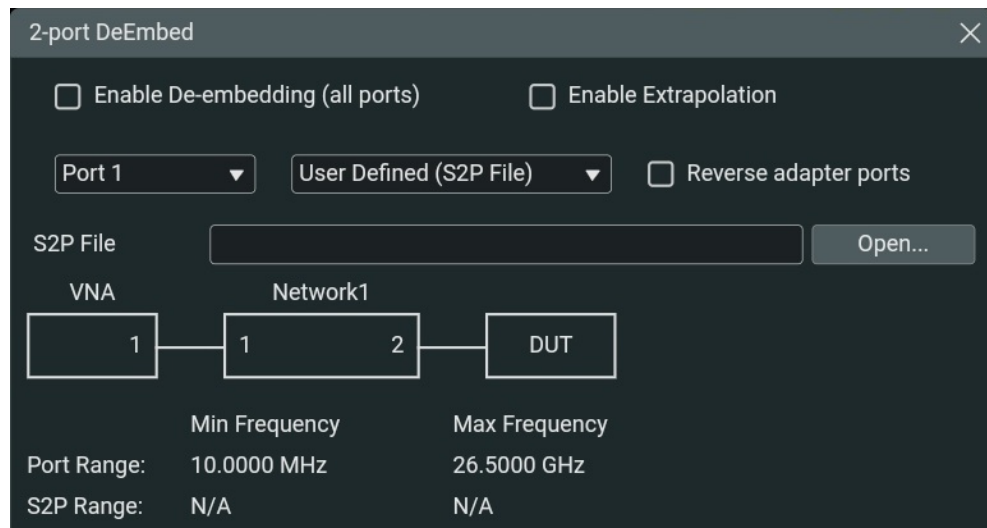

1. Check the checkbox of **Enable De-embedding (all ports)** to enable the port de-embedding function.
2. Click or tap the drop-down button to select the desired VNA port (Port 1/Port 2) to be de-embedded.

3. Click or tap to select "None" or "User Defined (S2P File)" from the drop-down list. When "User Defined (S2P File)" is selected, you can select the path where to load the "*.S2P" file.

Click or tap **Open** to enter the file management interface (*File Management*), select the desired "*.S2P" file to be loaded, then click or tap **Confirm** to complete loading.

The "*.S2P" file is the S-parameter file of 2-port network, which is used to simulate the representation of component model of the fixture in the actual test circuit.

4. When you use the 2-port fixture to connect the VNA and the DUT, the connection method of the fixture may affect the accuracy of the measurement results. "Reverse adapter ports" feature is used to adjust the port configuration between the fixture, VNA, and DUT to adapt to the actual connection conditions.

Generally, Port 1 connects one port of the VNA, and Port 2 connects the DUT. However, in some special test scenarios or in the fixture design, you need to connect Port 2 to the VNA and connect Port 1 to the DUT, at this time, you can check the checkbox of "Reverse adapter ports" to adjust the connection method.

The reverse of the adapter ports actually changes the signal transmission path and measurement reference direction, enabling the VNA to analyze and process measurement data based on the new port connection configuration, thus removing the effects of the fixture on the measurement results accurately.

5. When the frequency range of the loaded S2P file does not match the current measurement range, you can check the checkbox of **Enable Extrapolation**, the system will extend the values for the first and last data points in either direction through algorithm to make it cover the frequency range of the current measurement, ensuring the port match function works normally.

14 Power

Sets the power parameters of the stimulus source. In this menu, you can set the output power of the test port within the frequency range to ensure to use the proper stimulus power to make measurement within the specified frequency range.

Enable or Disable Power

Enables or disables whether the test port outputs the RF stimulus signal. By default, it is enabled. The stimulus source settings are global to all the channels.

Port Power

When you set the sweep type to "Linear Frequency" or "Log Frequency" (click or tap **Sweep** > **Main** > **Type**), you can set the power at the test port.

Start Power/Stop Power

When you set the sweep type to "Power" (click or tap **Sweep** > **Main** > **Type**), you can set the start power and stop power of the sweep signal.

The start power can be greater than the stop power, which indicates that power sweep goes from large values to small values, and no direction is required to be set.

15 Avg BW

The averaging and bandwidth function is used to reduce the random noise and improve measurement accuracy. Modifying the averaging parameters and IF bandwidth will affect the measurement time and measurement accuracy for the current channel.

15.1 Main

The vector network analyzer reduces the random noise on the measurement by the following two methods.

- Reducing IF BW
- Launch sweep averaging

Sweep averaging can be more effective than reducing IF bandwidth. However, comparing with reducing the IF bandwidth, it takes a longer time for sweep averaging in reducing noises, especially if many averages are required. Besides, changing IF bandwidth after calibration will result in uncertain accuracy.

IF BW

Intermediate Frequency Bandwidth (IF Bandwidth) is the width of the intermediate frequency band produced after mixing within the vector network analyzer's receiver. It is the bandpass width of the receiver's internal filter and represents the receiver's ability to filter signal frequency components. Reducing the IF receiver bandwidth reduces the random noise on the measurement. Each tenfold reduction in IF bandwidth lowers the noise floor by 10 dB. However, narrower IF bandwidth result in longer sweep time.

The range of the IF bandwidth is from 1 Hz to 10 MHz. By default, it is 100 kHz. The status bar at the bottom of the screen shows the IF BW value. Here BW refers to IF Bandwidth.

Averaging State/Averaging Times

The averaging feature performs averaging calculation on the measurement results for several times, reducing the error arising from uncertain factors in a single measurement, reducing the effect of random noise on the measurement results, making the results more stable and accurate.

Check the checkbox of the **Averaging** menu to enable the averaging function. By default, it is disabled. Each time you enable the averaging function, the measurement restarts to perform the averaging operation again. If you select "Sweep" for the averaging type, then after enabling averaging, the averaging progress (Channel No. Avg = Average Count Completed/Total Average Counts) for the current channel is

displayed at the lower-left part of the trace window. If you disable averaging function, the average count progress disappears.

Average count indicates the number of counts for averaging. Its range is from 1 to 65,535 ($2^{16} - 1$). By default, it is 1.

Restart Averaging

Clears the current measurement data and restarts sweep averaging again for a new set of measurements. All the traces of the current active channel will be replotted.

The Restart Averaging function is not applicable to Point averaging. It is only valid when the averaging function is enabled.

Average Type

- **Point Averaging**

Each data point is measured for a specified number of times, then averaged, before going to the next data point. The point averaging type is generally used in the scenarios where the frequency response is relatively stable or the measurement time is short. The sweep time of the point averaging is increased exponentially based on the average count.

- **Sweep Averaging**

Computes averaging on subsequent sweeps until the required number of averaging sweeps is performed. This averaging type can reduce the noise in the whole frequency range, and especially effective for the measurement with fast changing frequency response. By default, the averaging type is Sweep averaging.

15.2 Smoothing

Trace smoothing averages a number of adjacent data points to smooth the displayed trace. The number of adjacent data points that get averaged is also known as smoothing aperture. The trace smoothing can reduce the peak-to-peak noise on the broadband measured data. It smooths the trace noise and will not increase measurement time significantly.

Enable Smoothing

By default, smoothing is disabled. When enabled, smoothing is applied to the current active trace.

As trace smoothing follows format in the data processing map, the formatted data is smoothed. If *Data Format* is Polar or Smith Chart, smoothing is automatically disabled.

Smoothing Aperture

Specifies the percent of the swept stimulus span (X-axis) to smooth. For example, for a trace that contains 101 data points, if the smoothing aperture is 11%, then the number of data points that are averaged is 11. The range of the smoothing aperture is from 0% to 25%. By default, it is 1%.

Smoothing Points

Specifies the number of adjacent data points to average. It can only be set to an odd number. By default, it is 3.

15.3 Group Delay Aperture

Group Delay

Group delay is the time delay of the amplitude envelope of a signal as it passes through a device or network. It represents the rate of change of phase shift with respect to frequency, indicating how different frequency components within a signal experience different transmission delays through the device. The group delay is a measure of phase distortion. It describes the transit time of a signal through a device versus frequency. If the group delay of a system is a constant value for all the frequencies, it indicates that the transmission speed of the frequency components is the same, which will not cause signal distortion.

The phase characteristics of a device typically consists of both linear and higher order (deviations from linear) phase-shift components.

- Linear phase-shift component represents average signal transit time, attributed to electrical length of test device.
- Higher-order phase-shift component represents variations in transit time for different frequencies. It is the source of signal distortion.

For a linear time-invariant (LTI) system, the relationship between input and output can be characterized by its frequency response.

$\tau(\omega) = -d\phi(\omega)/d\omega$, wherein, ω indicates the angular frequency, $\phi(\omega)$ Indicates the frequency response;

$\tau(f) = -d\theta/df$, wherein, θ indicates phase angle; f indicates the frequency.

TIP

The group delay function is only valid when the data format is Group Delay. The setting is only valid for the current active trace.



Group Delay Aperture

Group delay aperture typically refers to the frequency resolution of the measurement system in group delay measurements.

During a group delay measurement, phase is measured at two closely spaced frequencies and then computes the phase slope. The frequency interval (frequency delta) between the two phase measurement points is called the aperture. Changing the aperture can result in different values of group delay. The computed slope (-delta phase / delta frequency) varies as the aperture is increased. Therefore, when you compare group delay data, you must know the aperture that was used in measurements.

- **Narrow aperture:** provides more details in phase linearity, making measurement susceptible to noise (smaller signal-to-noise ratio) and phase detector resolution.
- **Wide aperture:** provides less details in phase linearity, because some phase response is averaged out or not measured, making measurement less susceptible to noise (larger signal-to-noise ratio).

If the group delay aperture is set too large, it may lead to over-smoothing of the measurement results, thereby missing some important phase variation details; if set too small, it may result in increased measurement noise, affecting the stability and accuracy of the measurement results.

The number of adjacent data points can be set using any of the following methods. The three options set the aperture from different angles. Modifying one parameter will affect the other two parameters.

Formula: $(\text{Aperture Points} - 1) / (\text{Sweep Points} - 1) = \text{Percent of Span}$

$(\text{Sweep Stop Frequency} - \text{Sweep Start Frequency}) / (\text{Sweep Points} - 1) = \text{Sweep Points Interval}$

$\text{Sweep Points Interval} * (\text{Aperture Points} - 1) = \text{Aperture Frequency}$

- **Percent of Span:** The data points within this percentage of the current frequency span are averaged. The range is from (2 points/current number of points) to 100%. The span must contain at least two data points.
- **Points:** indicates the number of adjacent data points to average. By default, it is set to 11. It ranges from 2 to the current number of sweep points in the channel.
- **Frequency:** The data points within this frequency range are averaged. The frequency range must contain at least two data points.

When the frequency span or number of points is reduced so that the current Group Delay Aperture is not attainable, the Aperture is adjusted to the new frequency span or number of points.

16 Trigger

The trigger function causes the analyzer to select the trigger source and make a measurement.

16.1 Main

The settings in this menu are valid for the currently selected channel.

Trigger State

The trigger states includes the following types. Check the checkbox of the specified trigger state, and the checkbox turns green, indicating it is the currently selected trigger state.

- **Hold:** The trigger hold state, indicating the channel does not receive any trigger signal and the trace will not update.
- **Single:** The channel receives a single trigger signal, then goes to the Hold state. At this time, the trace updates once and then stops.

- **Groups:** The channel only receives the specified number of triggers, then goes to Hold state. The trace updates for a specified times, then stops.

The trigger times ranges from 1 to 2000000. By default, it is 1.

- **Continuous:** By default, continuous trigger is selected. The channel can receive an infinite number of trigger signals. The trace updates continuously.

Restart Trigger

Click or tap **Restart**, then all the channels that stays not in "Hold" state will be triggered in sequence based on the channel ID. Other trigger parameters of the channel remain unchanged.

Trigger Source

Only when the analyzer is not sweeping, can a valid trigger signal be generated.

The following trigger sources are available.

- **External:** receives external signals via the rear-panel TRIG IN connector as the trigger source.
- **Internal:** It is the default setting for trigger source. When you select internal trigger source, the continuous trigger signals are generated by the analyzer.

- **Manual:** When you select "Manual" trigger source, click or tap **Manual Trigger** to generate a trigger signal. You can also click or tap the manual trigger icon on the quick operation toolbar at the top of the screen to generate a trigger signal.

Only when you select "Manual" trigger source, can the **Manual Trigger** menu be enabled and the manual trigger icon on the quick operation toolbar at the top of the screen be valid.

Trigger Scope

Sets the scope where the trigger signal is sent. The available scopes include:

- **Global:** default setting. All channels that are not in "Hold" state will receive the trigger signal.
- **Channel:** Based on the channel ID, each time only one channel that stays not in "Hold" state can receive the trigger signal in sequence. It is recommended when you set the trigger source to Manual or External.

Trigger Mode

This option is enabled when you set **Scope** to "Channel" and set **Source** to "Manual" or "External".

The available trigger modes include:

- **Channel:** each trigger causes all the traces in the channel to be swept in the specified order.
- **Point:** each manual or external trigger causes one data point to be measured. Subsequent triggers go to the same trace until all the data points of the trace have completely measured. Then other traces in the same channel are swept in the specified order.

In the Point trigger mode, when you select "Single" or "Groups" trigger state, the trigger count is decremented by one after all data points on all traces in the channel are measured.

- **Sweep:** Each manual or external trigger signal causes all traces that share a source port to be swept in the specified order.

When you select "Single" or "Groups" trigger state, the trigger count is decremented by one after all traces in all directions are swept.

16.2 Input

Only when the trigger source is set to "External", can the input configuration be valid. The external trigger signal is input from the rear-panel TRIG IN connector.

Global Trigger Delay

Sets the time interval during which the instrument waits to start the sweep operation after the trigger signal that meets the trigger conditions is received. Its range from 0 s to 3 s. By default, it is 0 s.

Level/Edge

Sets the trigger condition. You can select the condition where the input trigger signal is triggered. The available choices include "High Level", "Low Level", "Positive Edge", and "Negative Edge".

16.3 Output

Configures the output trigger signal parameters to output from the rear-panel TRIG OUT connector.

Enable or Disable the Trigger Output

Enables or disables outputting trigger signals from the rear-panel TRIG OUT connector. By default, it is disabled.

Polarity

- Positive Pulse: the output pulse is the positive pulse.
- Negative Pulse: the output pulse is the negative pulse. By default, it is Negative pulse.

Position

- Before Acquisition: sends a pulse immediately before starting the data acquisition.
- After Acquisition: sends a pulse immediately after completing the data acquisition. This is the default setting.

Per Point

- OFF: sends the trigger signal at each sweep. This is the default setting.
- ON: sends the trigger signal when acquiring each data point.

Pulse Duration

Indicates the pulse width of the output trigger signal. Its range is from 1.00 μ s to 1 s. By default, it is 1.00 μ s.

17 Scale

The **Scale** menu mainly includes the vertical scale and related settings. You can set the scale, reference level, and reference position (and format) to determine the data trace on the VNA screen.



17.1 Main

Auto Scale

Click or tap **Auto Scale** to set value of the vertical divisions and reference value to fit the active data trace within the grid area of the screen.

- The analyzer determines the smallest possible scale factor that will allow all the displayed data to fit onto 80 percent of the vertical grid.
- The reference value is auto adjusted to center the trace on the screen.

The stimulus values and reference position are not affected when performing the auto scale operation.

Auto Scale All

Click or tap **Auto Scale All** to automatically scale all data traces in the active window to fit vertically within the grid area of the screen.

Scale

Click or tap **Scale** to set the vertical scale manually. That is, set the value of the vertical divisions of a rectangular display format.

The unit of the scale varies according to the trace data format. In Polar and Smith formats, scale sets the value of the outer circumference.

Reference Level

Click or tap **Reference Level** to set the value of the reference line in the vertical axis in a rectangular format. The reference level varies based on the trace data format. In Polar and Smith formats, reference level is invalid.

Reference Position

Adjusts the position of the reference line to move it up and down in the vertical direction. Click or tap **Reference Position** to set the position of the reference line in the vertical axis in a rectangular format manually. 0 is the bottom line of the screen and 10 is the top line. By default, it is set to 5 (middle). In Polar and Smith formats, reference position is invalid.

17.2 Electrical Delay

Electrical Delay refers to the linear phase delay caused by the physical length and dielectric constant when a signal transmits in the device under test. The electrical delay of the VNA specifies the value of delay added or removed, in Time or Distance. It can be used to compensate for the linear phase shift through a device to make the measurement results more accurate. You can set the electrical delay independently for each measurement trace.

Set the Electrical Delay Time/Distance

- Click or tap **Electrical Delay Time** to set the electrical delay time, expressed in s.
- Click or tap **Electrical Delay Distance** to set the electrical delay distance.

Click or tap **Distance Units** to set the unit of the electrical delay distance. The available units are meter, feet, and inch.

The "Electrical Delay Time" and "Electrical Delay Distance" are correlative. Modifying one parameter will affect the other.

Velocity Factor

Velocity Factor (VF) is used to describe the ratio of the transmission speed of electromagnetic waves in the medium relative to the speed of light in the vacuum. $VF = v/c$. Wherein, v indicates the transmission speed in the medium; c indicates the light speed.

The velocity factor is smaller than or equal to 1, which is related to the dielectric constant (ϵ_r) of the medium. It directly affects the transmission line electrical length calculations, time delay compensation, and calibration accuracy.

Click or tap the input field of **Velocity Factor** to set the velocity factor that applies to the medium of the device that was inserted after the measurement calibration. The velocity factor of the common transmission medium is as follows:

- Polyethylene dielectric cable: 0.66

- PTFE dielectric: 0.7
- Speed of light in a vacuum: 1.0

17.3 Constants

System Impedance

The actual impedance of the VNA hardware test port is generally 50 Ω . The system impedance can be changed for measuring device with an impedance other than 50 Ω , such as waveguide devices.

VNA mathematically transforms and displays the measurement data as though the VNA ports were the specified impedance value. Physically, the test ports are always about 50 Ω .

Phase Offset

Click or tap input field of **Phase Offset** to set the phase offset. By default, it is 0°.

- **Optimize the display effects of the phase measurement:** The method is the same as modifying the reference level in magnitude measurement. Adjust phase response to make it in the middle of the screen or aligned.
- **Simulate the expected phase offset in the measurement:** If a cable is connected to the instrument and the cable length may cause some phase offset for the measurement setup, then you can set the phase offset to correct the offset.

Magnitude Offset

Click or tap **Magnitude Offset** to offset the magnitude data of the current active trace by a fixed value in dB in the vertical coordinate (Y-axis).

Magnitude Offset Slope

The magnitude offset slope shows that the magnitude offset varies with the frequency. The offset slope begins at 0 Hz, in dB/GHz.

Click or tap **Magnitude Offset Slope** to offset the data trace by a value that changes with the frequency, making the current active trace to move in the vertical coordinate (Y-axis) based on the set magnitude offset slope. On the screen, you can see the slope varies with the frequency dynamically while the trace moves up and down, making it vary linearly within the frequency range.

18 Math Operation

The VNA supports saving the current data trace to the internal memory, and performs math operation on the current data trace and memory trace. The data analysis function includes the data transform of S-parameters, enabling statistics for the data of the active trace, making statistics of the mean value, standard deviation, and peak-to-peak values, and enabling the limit test.

18.1 Memory

Data->Memory

Click or tap **Data->Memory** to save the measurement data of the active trace to the memory. Click or tap this menu for multiple times, and the latest data of the current active trace will be saved to the memory. You can only store one memory trace data for each trace.

Data Math

Before performing the data math operation, perform "Data->Memory" operation first to ensure that there are available active trace data in the memory. Then perform the specified type of math operation on the current measurement data of the active trace and the trace data stored in the memory and then display them in the specified format..

The math operation types supported include:

- **Off:** By default, it is disabled. No math operation is performed on the current measurement data.
- **Data / Memory:** Current measurement data is divided by the trace data in the memory. It is used for ratio comparison of two traces.
- **Data - Memory:** Data in the memory is subtracted from the current measurement data.

It can be used for storing a measured vector error, then subtract this error from the DUT measurement to gain a more accurate result.

- **Data + Memory:** Current measurement data is added to the data in the memory. It can be used to add measurement results.
- **Data * Memory:** Current measurement data is multiplied by the data in the memory. It can be used for some special analysis requirements.

Normalize

The **Normalize** menu functions the same as performing "Data->Memory" first, and then "Data / Memory". Current measurement data is divided by the trace data in the memory. The normalized operation results will be shown on the current active trace, and the data math will be automatically switched to "Data / Memory".

The Normalize operation aims to perform one reference measurement in the preset condition and saves the measurement data to the memory as the reference data. Then perform the actual measurement, compare the actual measurement data with the reference data, and perform data math operation. The Normalize operation can eliminate the error caused by the system, making the measurement results more accurate.

Display

Sets the data display mode of the currently selected trace.

- **Data Trace:** displays the current measurement data of all the created traces.
- **Memory Trace:** displays the trace that was put in memory. If no memory data of a certain trace is found, then the current measurement data of the trace will not be displayed.
- **Data and Memory:** displays both the current measurement data of the trace and the trace that was put in memory.

18.2 Analysis

Parameter Conversion

The vector network analyzer supports parameter conversion function. You can convert the measurement results of the S-parameter to the desired parameter mode. After conversion, the trace curve will change. Engineers can better observe the characteristics of the components.

Table 18.1 Conversion Type

Menu Function Key	Conversion Function	Formula
Off	Conversion disabled	-
Z-Reflect	Impedance (Z_r) in reflection measurement	$Z_r = Z_{0a} \times \frac{1 + S_{aa}}{1 - S_{aa}}$

Menu Function Key	Conversion Function	Formula
Z-Transmit	Impedance (Z_t) in transmission measurement	$Z_t = \frac{2 \times \sqrt{Z_{0a} \times Z_{0b}}}{S_{ab}} - (Z_{0a} + Z_{0b})$
Z-Trans-Shunt	Impedance (Z_t) transmission shunt	$Z_t = \frac{1}{Y_t}$
Y-Reflect	Admittance (Y_r) in reflection measurement	$Y_r = \frac{1}{Z_r}$
Y-Transmit	Admittance (Y_t) in transmission measurement	$Y_{0a} = \frac{1}{Z_{0a}} Y_{0b} = \frac{1}{Z_{0b}}$ $Y_t = \frac{2 * \sqrt{Y_{0a} * Y_{0b}}}{S_{ab}} - (Y_{0a} + Y_{0b})$
Y-Trans-Shunt	Admittance (Y_t) in transmission measurement	$Y_t = \frac{2 * \sqrt{Y_{0a} * Y_{0b}}}{S_{ab}} - (Y_{0a} + Y_{0b})$
1/S	Inverse S-Parameter	$\frac{1}{S_{ab}}$
Conjugation	Complex conjugate number	-

Statistics

Check the checkbox of **Statistics**, and the checkbox is filled in green. The statistical function for the current active trace is enabled. The statistics information is displayed at the upper-right corner of the window, as shown in the figure below. Uncheck the checkbox of **Statistics**, then the statistical function for the current active trace is disabled. The statistics information will not be displayed at the upper-right corner of the window.

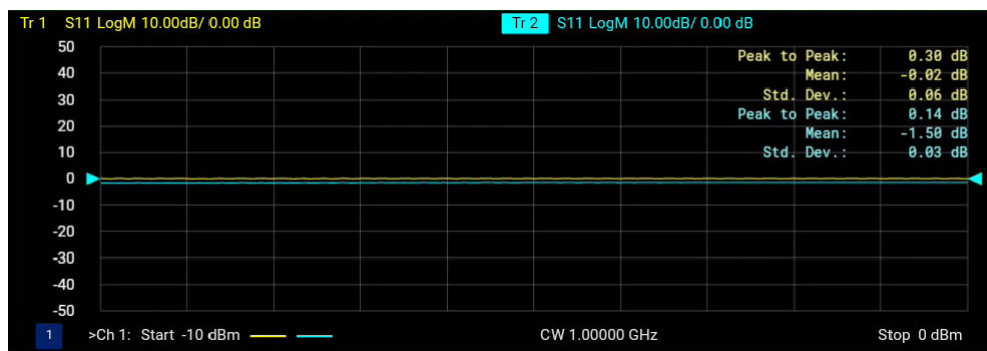

Click or tap the input field of **Statistics** to set the statistics range for the current trace.

- **Full Span:** By default, it is full span. That is the whole X-axis, which is the same as the sweep range of the trace itself.
- **User 1 to User 16:** makes statistics within the user-defined span. This settings are the same as what you set for the **Search Domain** sub-menu under **Search**.

At most, 16 user-defined range can be set. You need to set **Domain Start** and **Domain Stop** for each user-defined range. The user-defined ranges are independent of each other and can overlap with each other.

The statistics information includes the following items:

- **Peak to Peak:** indicates the peak-to-peak value of the trace within the statistical range.
- **Mean:** indicates the mean value of the trace within the statistical range.
- **Std. Dev.:** indicates the standard deviation of the trace in the statistical range.

18.3 Limit Test

Limit test compares the measured data with the defined limit value to judge whether the response data of the measurement meet the PASS/FAIL conditions to obtain the test result.

To configure the limit test parameters, click or tap **Limit Test** in the "Math" menu. The measurement interface of the limit test is as shown in the figure below.



1. Limit Table

Used to define whether the response data of measurement complies with the pass standards. Each line has a judge standard. By default, the limit table is disabled. When enabled, the limit table displaying the current active trace is displayed below the window.

2. Limit Line

The judge standards defined for each line in the limit table includes begin stimulus (X-axis) and end stimulus (X-axis); begin response (Y-axis) and end response (Y-axis). They form a limit line on the screen. The limit line is a dotted line, and its color is the same as the trace color. For each measurement trace, you can set multiple discrete limit line to test the characteristics of the response of the test component.

3. Test Result

When you enable the limit line, the result is displayed in the window. The data points that fail are displayed in red.



TIP

The limit line and limit test are not applicable to **Smith Chart** or **Polar Chart** display format. If the limit line and limit test are both enabled, when you select Smith or Polar format, the system exits the limit test automatically.

18.3.1 To Enable or Disable the Limit Test

Enable/Disable

By default, the limit test is disabled. When enabled, the measurement data trace will compare with the set limit line to display PASS or FAIL result.

Limit Line

By default, the limit line is disabled. When enabled, the limit line is displayed on the screen. When you enable the limit test and disable the limit line, the limit test will still continue.

Test Fail Sound

By default, sound on test failure is disabled. When enabled, the beep sounds when a point on the data trace fails the limit test.

18.3.2 Limit Table

Configure the Limit Table

You can add and edit the limit line information in the limit table. Each line in the limit table is a test rule for the limit line. To add a limit line, modify the "Type" parameter to a value other than "OFF", then a new line will be added automatically in the table. The "Type" parameter in the new line turns out to be "OFF".

- Click or tap the drop-down button of **Type** to select OFF, MAX, or MIN.
 - OFF: disables the limit line. That is, the limit line is invalid.

- MAX: The MAX value will fail measurements above this limit.
- MIN: The MIN value will fail measurements below this limit.
- Begin Stimulus: a value for the signal source to begin outputting stimulus signal. Click or tap the input field under Begin Stimulus parameter to input the value.
- End Stimulus: a value for the signal source to stop outputting stimulus signal. Click or tap the input field under End Stimulus parameter to input the value.
- Begin Response: a value for the signal source to begin measuring DUT output response. Click or tap the input field under Begin Response parameter to input the value.
- End Response: a value for the signal source to stop measuring DUT output response. Click or tap the input field under End Response parameter to input the value.

Load/Save Limit Table

Click or tap **Load Table**, then the file management interface is displayed. Select the specified limit table file suffixed with "*.csv", then click or tap **Confirm** to load the specified file to the limit table of the current active trace.

Click or tap **Save Table**, then the file management interface is displayed. Select the path to save the file, then click or tap **Save** to save the limit table of the current active trace as a file suffixed with "*.csv". If the file with the same filename already exists in the current path, then overwrite the original file.

For details about the file management method, refer to [File](#).

Example of Limit Table File (*.csv)

The limit table file suffixed with "*.csv" must contain the header in the following format.

```
"# VNA Limit Test"
"# Revision: 1.00"
TYPE,BEGIN STIMULUS,END STIMULUS,BEGIN RESPONSE,END RESPONSE
```

1. The first line indicates the limit test type of the instrument.
2. The second line indicates the limit test version.
3. The third line indicates the title of the output parameters starting to output from the fourth line.
4. The fourth line indicates outputting segment parameters and data.

18.3.3 Global Pass/Fail

Enable or Disable Global Pass/Fail

The Global Pass/Fail feature enables or disables monitoring the status of all measurements.

- **ON:** when you enable Global Pass/Fail, the status of all the measurements is displayed in the system status area. If any one of the traces fails in the limit line test, the result shows "FAIL"; if no failed measurement exists, it displays "PASS".
- **OFF:** when you disable Global Pass/Fail, the status of all the measurements is not displayed in the system status area.

Global Pass/Fail Policy

Sets the policy to determine the global pass/fail status.

- **All Tests:**

If all the limit tests pass, then the Global Pass/Fail status shows PASS.

- **All Measurements:**

If all the measured data points fall within the established test limits and limit test is ON, the Global Pass/Fail status will show PASS; if one measurement does not have limit test ON, the Global Pass/Fail status will show FAIL.

This setting is more critical. If all the test pass, it shows PASS; otherwise, it shows FAIL.

In this mode, if one measurement does not have Limit Test ON, the Global Pass/Fail status will show FAIL.

18.4 DTF (Option)

The DTF (Distance To Fault) feature identifies fault location and distance by analyzing reflected signals in the frequency domain. It calculates the distance from the fault point to the reference plane based on reflection characteristics and frequency response. Its working principle is as follows:

- Signal reflection mechanism:

When electromagnetic waves encounter impedance discontinuities (such as short circuit, open circuit, or loose connector) during transmission, a portion of the energy is reflected back to the source. The amplitude and phase of the reflected signal are related to the characteristics of the fault point (such as the variation of impedance) and its location.

- Conversion between time domain and frequency domain:

The VNA instrument measures the reflection coefficient (e.g., S_{11} parameter) in the frequency domain, then transforms the frequency domain data into time domain response through IFFT (Inverse Fast Fourier Transform). At this point, the horizontal axis of the time domain waveform represents time, which can be further converted to distance through the known velocity factor of signal transmission in the medium.

- Distance calculation:

DTF (L) can be obtained with the following formula: $L = (c*t*VF)/2$. Wherein, c indicates speed of light, t indicates round-trip of the reflection signal, and VF indicates the velocity factor.

You can configure the following DTF-related parameters:

DTF State

By default, DTF state is disabled. Only when the sweep type is set to *Linear Frequency* for the current trace, can you enable the DTF function. Otherwise, the DTF function is unavailable to use. DTF and TDA are mutually exclusive. When you enable either one of them, the other will be disabled automatically.

When DTF is enabled, the window presents the relationship between the transmission loss (Y-axis) and distance (X-axis). The measurement readout is displayed at the upper-right corner of the window, and the marker marks the position of the displayed marker. The unit of the X-axis can be selected from **Distance Unit**. By default, the unit is Meter. The available units include Meter, Feet, and Inch.

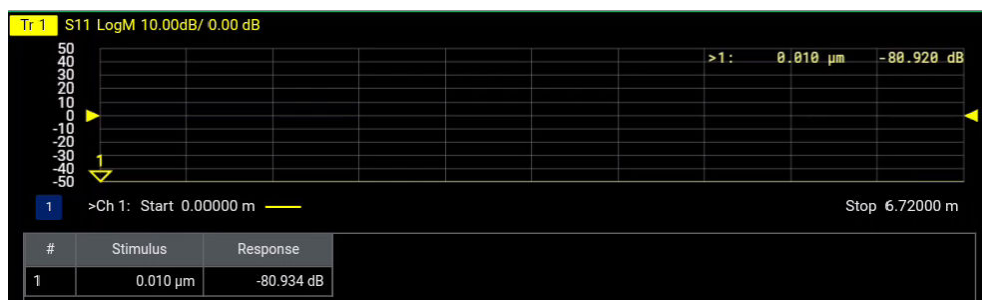

Stop Distance

The stop distance defines the distance range within which the DTF function can accurately measure fault points. The unit of stop distance is the one you select under "Distance Unit".

The function of stop distance:

- Enables you to filter out the signal data in the irrelevant regions, and to focus on measuring the target cable segment.

- The distance resolution of DTF (i.e., identifying the minimum fault interval) is related to the *Sweep* frequency span and sweep points. The stop distance determines the minimum number of sweep points required. Changing the stop distance will make the system to automatically adjust the number of sweep points.

Setting the stop distance can avoid long measurement time arising from too many sweep points; or low DTF resolution arising from insufficient sweep points.

- DTF can realize the conversion between the time domain and distance based on the IFFT of frequency data, and has a physical limitation of "unambiguous distance". If the configured stop distance exceeds the unambiguous distance, reflection signals originating from different fault locations will superimpose in the time domain, resulting in measurement failure.

Cable Loss

During cable transmission, electromagnetic waves will result in attenuation due to loss. Therefore, the longer the distance, the smaller the signal amplitude. If the reflection signal of the distance faults is too weak, it may cause misjudge of fault. Therefore, you need to compensate the signal attenuation caused by cable transmission.

Cable loss is the attenuation characteristics parameters of the signal in the cable transmission, expressed in dB/m. Configuring the cable loss can compensate the attenuation of stimulus signal in different positions of the cable, making the peak amplitude of the reflection signal at fault points of different distances in the transmission cable more precise, ensuring that the fault points can be identified accurately.

Velocity Factor

Velocity factor is the ratio of the transmission velocity of the signal in a medium to the speed of light in vacuum. For details, refer to *Electrical Delay*.

Through the velocity factor and the X-axis coordinate (time) where the specified measurement marker is located, you can obtain the distance (length) between the test port and the fault point.

Window Function

The available window types are Rectangular, Hanning Hamming, Gaussian, and Flattop. You can select a proper filter type by referring to the following table according to the actual measurement requirements.

Window Function	Spectral Leakage	Amplitude Accuracy	Frequency Resolution
Gaussian	Moderate	Good	Medium
Flattop	Good	Excellent	Poor
Rectangular	Poor	Poor	Excellent
Hanning	Good	Medium	Good
Hamming	Good	Medium	Good

18.5 Time Domain (TDA Option)

The VNA instrument is usually used to analyze the characteristics of the frequency domain of the device, but also can use the frequency domain parameters to calculate the inverse Fourier transform (IFFT) to obtain the characteristics of time-domain of the device.

TDA (Time Domain Analysis) feature enables the measured frequency domain data to convert to the time domain data through math calculation, and makes an analysis for the time domain characteristics of the DUT.

The basic principle of the TDA feature is: Send a signal on the transmission cable, and if mismatch impedance (such as Open Circuit, Short Circuit, and impedance variation) occurs during transmission, some signals will be reflected. Through measuring the delay between the transmission pulse and reflection pulse, in combination with the transmission rate of the signal on the transmission cable, you can determine the impedance distribution and fault location on the transmission cable.

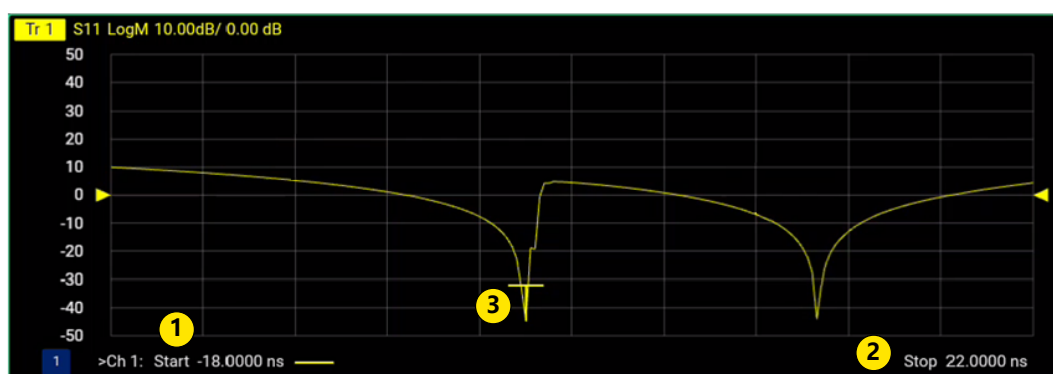

- **Transform State:**

By default, it is disabled. When it is enabled, the coordinate in the window switches to the time-domain mode. The measurement trace is displayed in the window, with the X-axis coordinate representing time.

- **Start Time:**

Sets the transform start time that is displayed on the analyzer screen, as ① indicated in the above figure.

- **Stop Time:**

Sets the transform stop time that is displayed on the analyzer screen, as ② indicated in the above figure.

- **Center Time:**

Sets the transform center time that is displayed in the center of the analyzer screen, as ③ (a T icon) in the above figure.

- **Span Time:**

Sets the transform span time that is split on either side of the center value. It is the difference between the transform stop time and transform start time in the window.

The start time, stop time, center time, and span time are mutually affected with each other. Changing the start time or stop time will also change the values of center time and span time. The start time and stop time will also be changed when modify the center time or span time.

Transform Type

Three transform types are available. They are three variations on how the time domain transform algorithm is applied to the frequency domain measurement.

- **Band Pass:** applicable to scenarios where resolution requirement is not high and requires rapidly locating problems in the wideband.

It features wide pulse and low resolution, applicable for measuring band limited devices.

- **Low Pass Impulse**

Narrow pulse, high resolution, easy to identify the tiny impedance variations in devices that pass low frequencies.

- **Low Pass Step:**

Step signal, sensitive rising edge, easy to identify inductive and capacitive discontinuities in devices that pass low frequencies.



NOTE

If you choose Low Pass Impulse or Low Pass Step, note that the start frequency shall be equal to the step frequency.

18.6 Time Gating (TDA Option)

The time domain gating feature converts the raw measurement data from the frequency domain to the time domain. In the time domain, data are filtered according to filtering conditions. The filtered data are then subjected to Fourier transform to convert it back into the corresponding frequency domain characteristic curve for further analysis. Time domain gating is a commonly used method to filter the frequency domain signal.

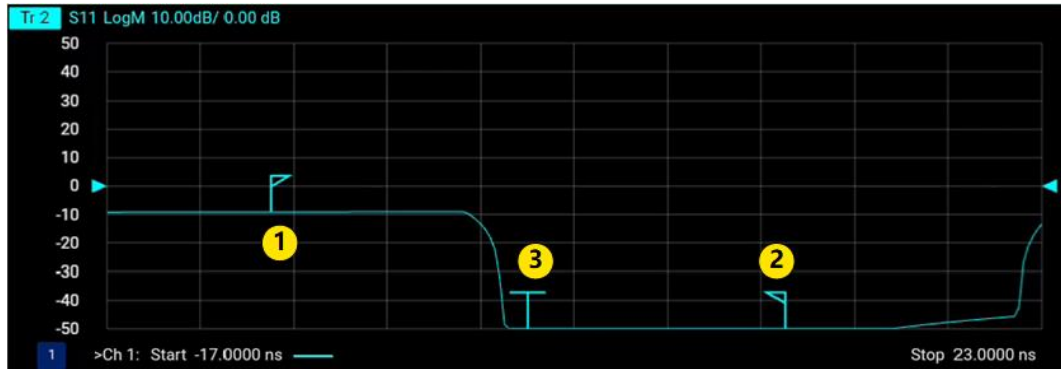

You can set the following parameters:

- **Gating State:**

By default, gating is disabled. When enabled, the measurement data will be filtered according to the set time gating condition. Before enabling the gating, first enable *Time Domain (TDA Option)* to convert the current measurement trace to be displayed in the time domain coordinate system.

- **Start Time:**

Sets the start time for the gate. It is indicated as ① (a flag icon) in the above figure.

- **Stop Time:**

Sets the stop time for the gate. It is indicated as ② (a flag icon) in the above figure.

- **Center Time:**

Sets the center time for the gate. It is indicated as ③ (a T icon) in the above figure.

- **Span Time:**

Sets the range to either side of the center value of the area that is affected by the gating function. It is the difference between the stop gate time and start gate time in the window.

The start time, stop time, center time, and span time are mutually affected with each other. Changing the start time or stop time will also change the values of center time and span time. The start time and stop time will also be changed when modify the center time or span time.

Gate Type

Defines the type of filtering that will be performed for the gating function.

- Band Pass: keeps the response data within the gate span.
- Notch: removes the response data within the gate span.

Gate Shape

Defines the filter characteristics of the gate function. The available gate shapes include Maximum, Wide, Normal, and Minimum. The definitions are as follows:

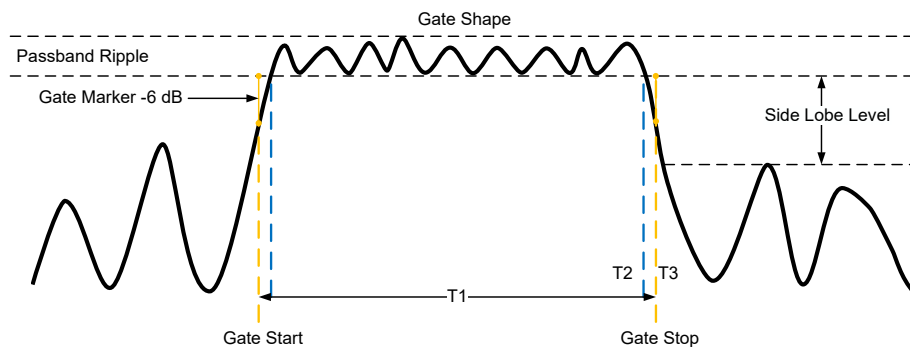

Gate Shape	Passband Ripple	Sidelobe Level	Cut-off Time	Minimum Gate Span
Min.	±0.1 dB	-48 dB	1.4/Frequency Span	2.8/Frequency Span
Normal	±0.1 dB	-68 dB	2.8/Frequency Span	5.6/Frequency Span
Width	±0.1 dB	-57 dB	4.4/Frequency Span	8.8/Frequency Span
Max.	±0.01 dB	-48 dB	12.7/Frequency Span	25.4/Frequency Span

Cut-off Time indicates the time between the stop time (-6 dB on the filter skirt) and the peak of the first sidelobe. The diagram above shows the overall gate shape and lists the characteristics for each gate shape.

- T1 is the gate span, which is equal to the stop time minus the start time.
- T2 is the time between the edge of the passband and the 6 dB point, representing the cut-off rate of the filter.
- T3 is the time between the 6 dB point and the edge of the gate stopband.

- For all the filter shapes, T2 is equal to T3, and the filter is the same on both sides of the center time.

Minimum gate span is twice the cut-off time. Each gate shape has a minimum recommended gate span for proper operation. This is a consequence of the finite cutoff rate of the gate. If you specify a gate span that is smaller than the minimum span, the response will show the following effects:

- Distorted gate shape that has no passband
- Distorted shape
- Incorrect indications of start and stop time
- May result in increased sidelobe level

18.7 Time Domain Setup (TDA Option)

Channel Coupling

Enables or disables the coupling state for the specified parameters of all the traces for the same channel.

- **Coupling State:**
 - ON: By default, it is enabled. When it is enabled, modifications of the specified parameters for the current active trace are global to all the traces of the current channel.
 - OFF: When it is disabled, modifications of the parameters for the current active trace will not affect the other traces of the current channel.
- **Transform Parameters:** selects the time domain transform related parameters that support channel coupling.
 - Stimulus: the "Start Time", "Stop Time", "Center Time", and "Span Time" settings in the **Time Domain** menu.
 - State (On/Off): the "Transform State" setting in the **Time Domain** menu.
 - Window: the "Kaiser Beta" and "Impulse Width" settings in the **Time Domain Setup** menu.
 - Mode: the "Transform Type" setting in the **Time Domain** menu.
 - Distance Marker Unit: the "Units" setting in the **Time Domain Setup** menu.

- **Gating Parameters:** selects the time domain gating related parameters that support channel coupling.
 - Stimulus: the "Start Time", "Stop Time", "Center Time", and "Span Time" settings in the **Time Gating** menu.
 - State (On/Off): the "Gating State" setting in the **Time Gating** menu.
 - Shape: the "Gate Shape" setting in the **Time Gating** menu.
 - Type: the "Gate Type" setting in the **Time Gating** menu.

Marker Mode

In the **Time Domain** menu, click or tap **ON** under **Transform State** to enable the time domain transform. Then in the marker measurement result of the current active trace, transmission cable length (Dist.) of the specified marker in the coordinate is added.

- Auto: selects the marker mode automatically according to the S-parameter of the current trace. For example, S12 is the transmission mode; S11 is the reflection mode.
 - Reflection: sets the current trace measurement to reflection parameter.
 - Transmission: set the current trace measurement to transmission parameter.
- Under the same measurement condition, if transmission mode is selected, the obtained transmission cable length is twice the length in the reflection mode.

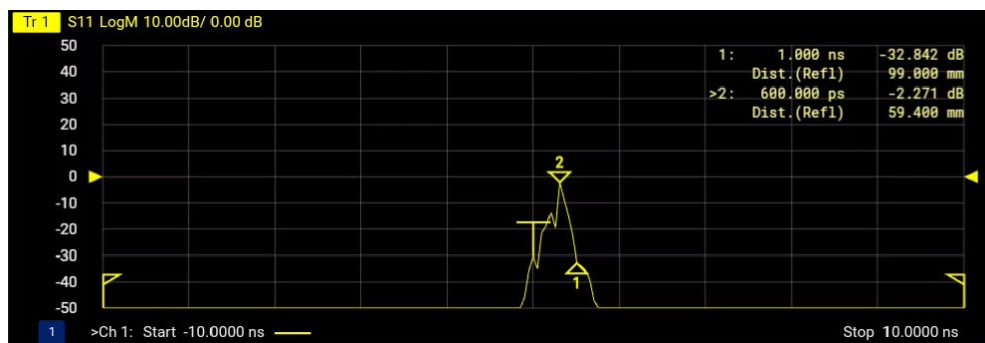

Distance Transfer

Configures the relevant parameters of the signal in converting the cable transmission time into cable length.

- **Units:** Specifies the unit of the distance (length) measured from test port to destination point. The available units are Meters (default), Feet, and Inches.

- **Velocity Factor:**

Indicates the ratio of the transmission velocity of the signal in a medium to the speed of light in vacuum. For details, refer to *Electrical Delay*.

Through the velocity factor and the X-axis coordinate (time) where the specified measurement marker is located, you can obtain the distance (length) between the test port and the destination point.

Window Function

In the TDA test, you can modify **Kaiser Beta** and **Impulse Width**. Beta parameter is inversely proportional to impulse width, and they are mutually affected with each other.

- The greater the Beta value, the narrower the impulse width and the higher the time resolution, applicable for detecting multiple impedance discontinuities at close range, but sidelobe suppression is relatively weak.
- The smaller the Beta value, the wider the impulse width and the stronger the sidelobe suppression, applicable for detecting weak reflection or long distance fault, but the time resolution is relatively low.

19 Setup

This menu allows you to perform quick operation for some functions, save, recall, and manage files.

19.1 Layout

In the Layout menu, you can quickly add, delete, and select the trace, channel, window, and sheet. For detailed information about the trace, channel, window, and sheet, refer to descriptions in "Trace" and "Channel".

- Click or tap **Add Trace**, **Add Channel**, **Add Window**, or **Add Sheet** to quickly add a trace, a channel, a window, or a sheet. They are set to be activated.
- Click or tap **Delete**, and the sub-menu shows the existing sheet, window, channel, and trace. If a green dot exists at the left side of the specified item, it indicates that the item is activated. Click or tap any of the items (trace, channel, window, or sheet) from the drop-down list of **Delete** to delete the desired one.
- Click or tap **Select**, and the sub-menu shows the existing sheet, window, channel, and trace. If a green dot exists at the left side of the specified item, it indicates that the item is activated. Click or tap any of the items (trace, channel, window, or sheet) from the drop-down list of **Select** to select the desired one to be activated. Once selected, a green dot will be highlighted at the left part of the selected item.

19.2 Sweep Setup

The sweep setup menu has the same function as the **Main** sub-menu of **Sweep**. For detailed operations, refer to *Main* in "Sweep".

19.3 S-Parameter

The sub-menus of the **S-Param** in the S-Parameter menu are the same as that in **Measure > S-Param**. For detailed descriptions, refer to *S-Parameter* in the "Measure" menu.

19.4 Display Setup

Window Max

By default, Window Max is disabled. When you have created multiple windows, multiple windows are displayed on the screen simultaneously. When Window Max is enabled, the currently selected window will be maximized, and the "Window Max" label is displayed at the upper-right corner of the window.

In multi-pane windowing state, you can double-click the specified window to maximize the selected window; double-click it again to exit the "Window Max" state.

Grid Line

Sets the grid line in the window to "Solid" or "Dotted". By default, it is Solid.

Show Table

- None: default setting. The table is not displayed below the window.
- Marker: a marker table is displayed below the window.
- Limit: a limit test table is displayed below the window.
- Segment: a segment sweep table is displayed below the window.

Layout Mode

In multi-pane windowing, you can select the layout mode.

- Auto: default layout mode. The window size can be adjusted automatically based on the number of windows. Different windows can be different in size. The windows cover the whole window display area.
- Fixed: Adjusts the size of the window automatically based on the number of windows. Each window size is the same.

Max Window Count

By default, up to 9 windows are supported to be displayed in the window display area. The available max. window count can be set to 1, 2, 4, 6, and 9. When the number of created windows exceeds the max. number of windows that can be displayed in the window display area, click or tap **Pg Up** or **Pg Dn** to page up or page down the display interface to find the specified window.

19.5 Save

The Save operation is performed in the file management interface, as shown in the figure below.

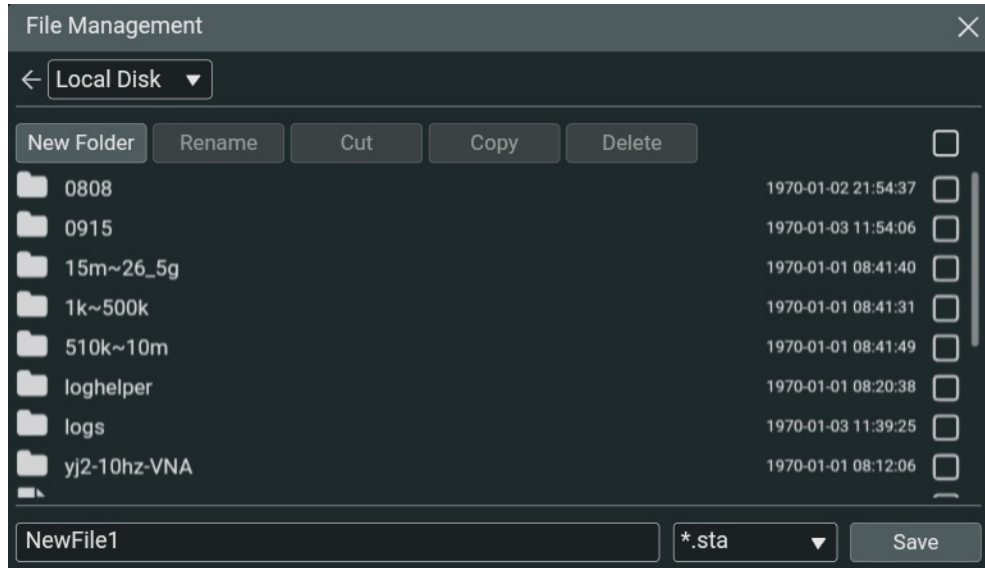

For the file management operation, refer to *File*. The procedures for saving the file are as follows:

- **Set the filename:** click or tap the input field of the filename, then the virtual keypad is displayed. Input the filename with the virtual keypad.
- **Select the file format:** click or tap the drop-down button of the file format to select the desired format.
- **Save:** click or tap **Save** to save the file with the specified filename and format to the current selected path.

Save State

Click or tap **Save State**, then the file management interface is displayed. Save the current state information of the instrument to the specified path with the filename suffixed with ".sta".

Save CalSet

Click or tap **Save CalSet**, then the file management interface is displayed. Save the current calibration sets information of the instrument to the specified path with the filename suffixed with ".cal".

State+CalSet

Click or tap **State+CalSet**, then the file management interface is displayed. Save the current state and calibration sets information of the instrument to the specified path with the filename suffixed with ".csa".

Save SNP

The *.snp file format is also known as Touchstone format. The "*.snp" data are usually used to gather all S-parameters for a fully corrected measurement. The file in Touchstone format is suffixed with "*.snp". Wherein, n indicates the number of ports. For example, "*.s2p" indicates a 2-port network; "*.s4p" indicates a 4-port network. The "*.snp" file contains the header information, stimulus data, and a response data pair for each S-parameter measurement. The file is a text file, and can be opened with the notebook.

Click or tap **Save SNP**, then the "Save SNP" interface is displayed.

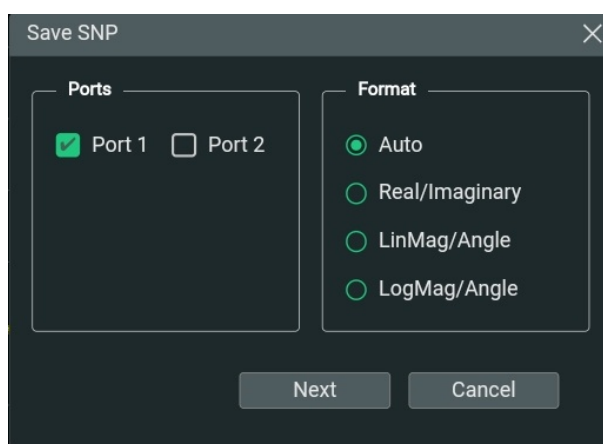

Select the specified port and format of the data to be saved, then click or tap **Next**. The file management interface is displayed. Save the current S-parameter information of the instrument to the specified path, with the filename "*.s1p" (single port data of Port1 or Port 2) or "*.s2p" (Dual-port data of both Port1 and Port2).

Save CSV

Click or tap **Save CSV**, then the "Save CSV" interface is displayed. Select the specified scope and format of the data to be saved, then click or tap **Next**. The file management interface is displayed. Save the current S-parameter information of the instrument to the specified path with the filename suffixed with "*.csv".

Screenshot

Click or tap **Screenshot**, then the current screen is captured and saved to the specified path with the specified filename suffixed with "*.png". After completing saving, the saving path is automatically displayed.

19.6 Recall

The Recall operation is performed in the file management interface, as shown in the figure below.

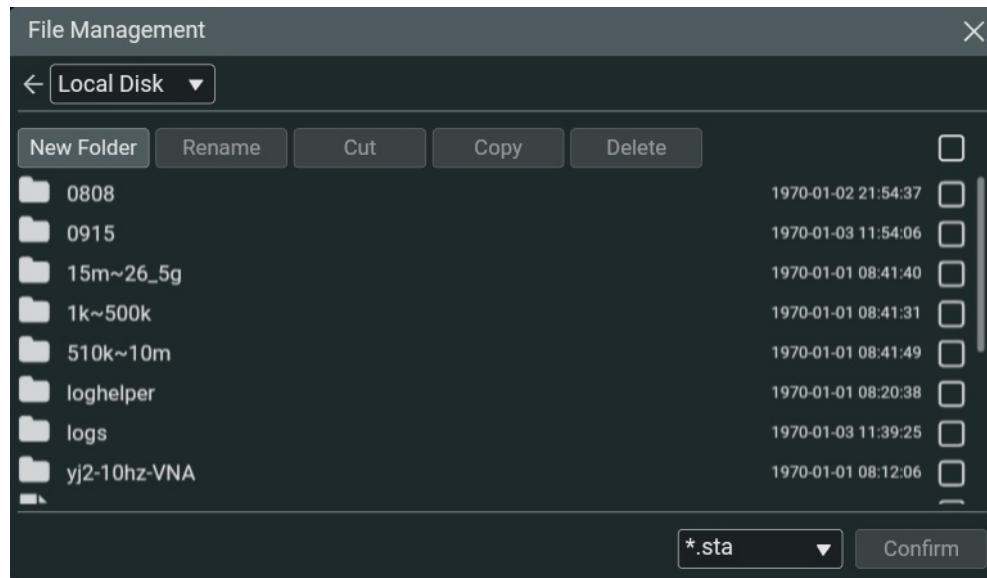

For the file management operation, refer to [File](#).

Recall State

Click or tap **Recall State**, then the file management interface is displayed. Select the specified "*.sta" file from the specified path, click or tap **Confirm** to complete the recalling operation.

State+CalSet

Click or tap **State+CalSet**, then the file management interface is displayed. Select the specified "*.csa" file from the specified path, click or tap **Confirm** to complete the recalling operation.

Recall CalSet

Click or tap **Recall CalSet**, then the file management interface is displayed. Select the specified "*.cal" file from the specified path, click or tap **Confirm** to complete the recalling operation.

Recall SNP

Click or tap **Recall SNP**, then the file management interface is displayed. Select the specified "*.snp" file from the specified path, click or tap **Confirm** to complete the recalling operation.

19.7 File

File Management

Click or tap **Manage Files**, then the file management interface is displayed.

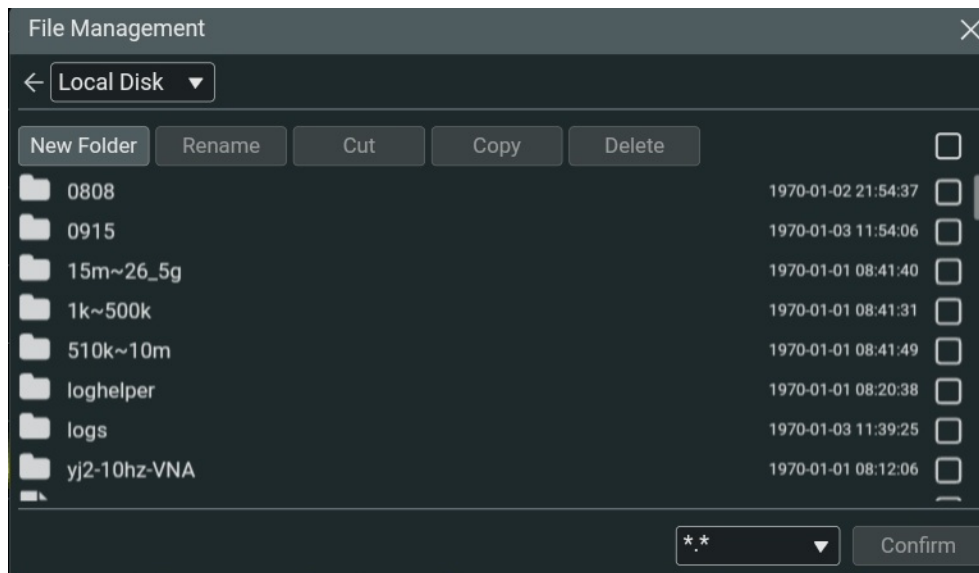

You can perform the following operations in the file management interface.

- **Select the Disk**

Before using the external storage device, please ensure that the USB storage device (FAT32 format, flash memory) is properly connected. By default, contents in the "Local Disk" are displayed in the file management interface. If an external storage device is inserted, "Removable USB Disk" is added to the available disks. Select "Removable USB Disk", then the contents of the USB Disk(D) is displayed in the file management interface.

- **Create a Folder**

Click or tap **New Folder**, then the virtual keypad is displayed, input the folder name to create a new folder.

- **Enter or Exit the Folder**

Double-click or tap the specified folder to open the folder. The contents in the folder are displayed. The current path can be seen in the disk selection area. Click or tap <- to exit the current folder and go back to the previous level of folder.

- **Select a File or Folder**

Before operating on a file or folder, first select the file or folder. Check the checkbox of the specified file or folder to select it. You can select multiple files or folders.

- **Rename a File or Folder**

Select the specified file or folder, click or tap **Rename**, then the virtual keypad is displayed. Input the filename or folder name. Click **OK** to complete the input.

- **Delete a File or Folder**

Select a file or folder to be deleted. Click or tap **Delete**, then a prompt message that prompts you to confirm whether to delete the file or folder is displayed.

Click or tap **Confirm** to confirm deleting it. Click or tap **Cancel** to cancel deleting operation.

- **Copy, Cut, and Paste a File or Folder:** Select a file or folder, then click or tap the specified button such as cut, copy, or paste to perform the specified operation.

Safe Clear

Click or tap **Safe Clear**, then a prompt message "Are you sure to execute secure memory wipe?" is displayed. Click or tap **Confirm** to clear the internal memory safely. Click or tap **Cancel** to cancel safe clear operation.

Upgrade

This instrument supports local upgrade.

1. Save the upgrade file suffixed with "*.GEL" to the specified path of the instrument.
2. Click or tap **Upgrade**, then the file management interface is displayed.
3. Select the upgrade file from the destination path. Then click or tap **Confirm** to start local upgrade.

20 Save & Recall

This menu allows you to perform quick operation for saving, recalling, and managing files.

Save

The saving operation is the same as what described in **Save** menu under **Setup**. For details, refer to *Save*.

Recall

The recalling operation is the same as what described in **Recall** menu under **Setup**. For details, refer to *Recall*.

File

The file management operation is the same as what described in **File** menu under **Setup**. For details, refer to *File*.

21 System

In the **System** menu, you can set the system-related parameters, I/O settings, etc. To enter the System menu, perform the following operation.

- Click or tap the notification area at the lower-right corner of the screen to enter the **System** menu.
- Press  to enter the **System** menu.

21.1 I/O Setting

In the **System** menu, click or tap **IO** to enter the I/O interface settings. You can configure the following parameters.

Network Status

Different prompts will be displayed according to the current network connection status.

- Network Config Succeeded!
- Acquiring IP...
- IP Conflict!
- DISCONNECTED!
- DHCP Config Failed
- Read Status Fail!
- CONNECTED
- Invalid IP
- IP lost
- Please wait...

MAC Address

The MAC address of each oscilloscope is unique. When assigning the IP address for the oscilloscope, the system uses the MAC address to identify the instrument.

VISA Address

Displays the VISA address currently used by the the instrument.

IP Configuration Type

The configuration type of the IP address can be DHCP, Auto IP, or Static IP. In different IP configuration types, the configurations for IP address and other network parameters are different.

- **DHCP**

If "DHCP" is selected, the DHCP server in the current network will assign the network parameters (e.g. IP address, Subnet, Gateway, and DNS) for the instrument.

- **Auto IP**

When "Auto IP" is selected, the instrument will acquire the IP address ranging from "169.254.0.1" to "169.254.255.254" and the subnet mask (255.255.0.0) automatically based on the current network configuration. The "Auto IP" works only when "DHCP" is not selected or connection is failed.

- **Static IP**

If "Static IP" is selected, the instrument is configured with static IP. In this case, you need to disable DHCP and Auto IP manually. At this time, you need to set the IP address, Subnet, Gateway, and DNS manually. At this time, you can self-define the network parameters (e.g. IP address) of the instrument.

- **Set the IP address**

The format of the IP address is nnn.nnn.nnn.nnn. The range of the first segment (nnn) of the address is from 0 to 255 (except 127); wherein, the valid range is from 0 to 223. The range for the other three segments is from 0 to 255. You are recommended to ask your network administrator for an IP address available.

- **Set the subnet mask**

The format of the subnet mask is nnn.nnn.nnn.nnn. Wherein, the range of "nnn" is from 0 to 255. You are recommended to ask your network administrator for a subnet mask available.

- **Set the default gateway**

You can set this parameter in Static IP mode. The format of the gateway is nnn.nnn.nnn.nnn. The range of the first segment (nnn) is from 0 to 223 (except 127), and the range for the other three segments is from 0 to 255. You are recommended to ask your network administrator for a gate address available.

- **Set the DNS address**

You can set this parameter in Static IP mode. The format of the DNS address is "nnn.nnn.nnn.nnn". The range for the first segment (nnn) of the address is from 0 to 223 (except 127); and the range for the other three segments is

from 0 to 255. You are recommended to ask your network administrator for an address available.

Generally, you do not need to set the DNS, therefore this parameter setting can be ignored.



TIP

- When the three IP configuration types are all turned on, the priority of the parameter configuration from high to low is "DHCP", "Auto IP", and "Static IP".
- The three IP configuration types cannot be all turned off at the same time.

mDNS

Click or tap the **ON/OFF** tab for mDNS to enable or disable the multicast Domain Name System (mDNS). This system is used to provide the function of DNS server for service discovery in a small network without a DNS server.

Host Name

The length of the host name is a string of 26 characters at most.

GPIB

When controlling the instrument via the GPIB, first use the USB-GPIB module to extend a GPIB interface, then use the GPIB cable to connect it to the PC. Configure the GPIB address. Its settable range is from 1 to 30. By default, it is 1.

Apply the Network Parameter Setting

Click or tap **Apply** to validate the current network parameter setting. Click or tap **Reset** to restore to the default settings.

The interface settings are saved to the non-volatile memory. Each time the instrument is restarted, it will load the last interface settings automatically.

21.2 Basic Settings

In the **System** menu, click or tap **Setting** to enter the basic setting menu.

Language

This product supports menus in multiple languages. The help information, prompt messages, and interface can be displayed in multiple languages. Click or tap the drop-down button of **Language** to select the specified system language from the drop-down list.

Power Switch

- OFF: After the oscilloscope is connected to power, you need to press the Power key on the front panel to power on the instrument.

- **ON:** After the the oscilloscope is connected to power, it will be powered on automatically.

Beeper

Click or tap the ON/OFF tab for **Beeper** to enable or disable the beeper. When the beeper is enabled, you can hear the sound of the beeper when you perform the following operations:



- Operate on the touch screen
- When a prompt message is displayed

Screen Brightness

Drag the slide to set the screen brightness. Its range is from 0% to 100%.

Show Time

Click or tap the ON/OFF tab for the **Show Time** menu to enable or disable the display of the system time. When enabled, the system time (date and time) is displayed in the Notification Area at the lower-right corner of the screen. The date is displayed in "yyyy/mm/dd" format, and the time is displayed in "hh:mm:ss" format. You can enable or disable the display of system time when saving the waveform. When enabled, the saved file will contain the system time information.

- **Date:** Click or tap the "Date" area, then the date setting interface is displayed. Drag the year, month, and day section up and down respectively to set the date. Click or tap **Confirm** to confirm the date modification. Click or tap the close window icon  to cancel the date modification and exit the menu. You can also click or tap any place other than the date setting interface to exit the date modification menu.
- **Time:** Click or tap the "Time" area, then the time setting interface is displayed. Drag the hour and minute section up and down respectively to set the time. Click or tap **Confirm** to confirm the time modification. Click or tap the close window icon  to cancel the time modification and exit the menu. You can also click or tap any place other than the time setting interface to exit the time modification.

21.3 About this Instrument

In the **System** menu, click or tap **About** to view the model of the instrument, its serial number, firmware version, etc.

- **Model:** indicates the product model.

- **Serial number:** indicates the serial number of the instrument. It is the unique identity of the instrument.
- **Firmware:** indicates the firmware version of the instrument.
- **Hardware:** indicates the hardware version of the instrument.
- **Build:** indicates the build time of the software version of the instrument.
- **Android. Build:** indicates the build time of the Android operating system.
- **Android.Version:** indicates the version number of the Android operating system. For example, 7.1. 0.
- **Launcher:** indicates the GUI version number of the Android operating system.
- **WebControl:** indicates the version number of the web control module.

Upgrade

This instrument supports local upgrade.

1. Save the upgrade file suffixed with "*.GEL" to the specified path of the instrument.
2. In the **System** menu, click or tap **About** > **Upgrade**, then the file management interface is displayed.
3. Select the upgrade file from the destination path. Then click or tap **Confirm** to start local upgrade.

21.4 Options

In the **System** menu, click or tap **Options** to view all the options. For the procedures of installing the option, refer to descriptions in *To View the Option and the Option Installation*.

22 Remote Control

This instrument supports Web Control remote operation. Web Control is Web-based remote control operation. With Web control, you can access and operate the LAN-connected instrument via the web page on any smart terminals such as PC, mobile, and iPad, without needing to install any software. The operation procedures are as follows:

1. Connect the instrument to the network

Ensure that the rear-panel LAN interface is connected to the network. Note that the instrument must be connected to the network where the control terminal is located. Then you can operate the instrument in remote way by accessing the network.

2. Obtain the IP address

In the **System** menu, click or tap **IO** to view the IP address of the instrument.

3. Input the IP address of the instrument into the browser address bar, then press Enter to access the web page, as shown in the following figure.

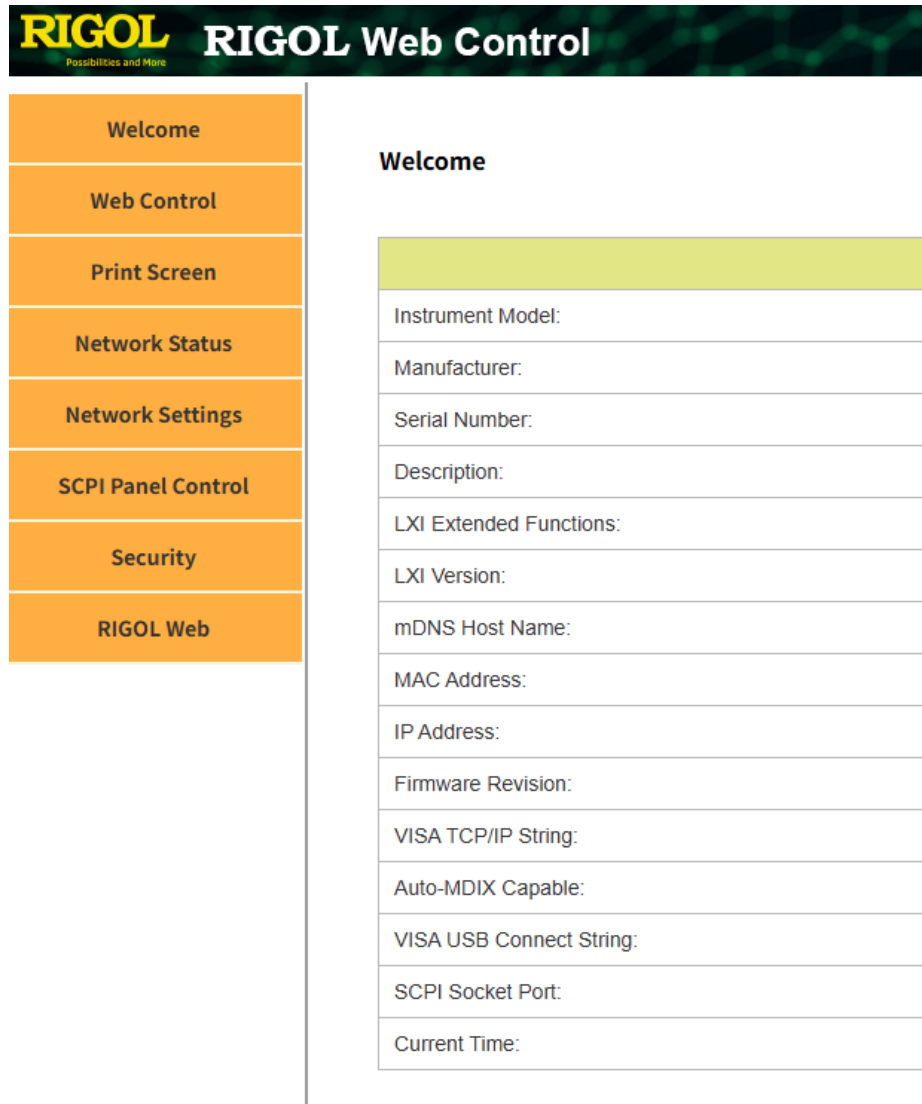

4. Click **Web Control** on the left side of the screen to enter the instrument remote control interface. You can use the mouse to remotely control the instrument in real time, with the same effect as operating the instrument directly.
5. Click **Print Screen**, and you can select "Take Screenshot" or "Record Screen" to capture the current screen shot.
6. Click **Network Settings** to configure the network. Note that login is required when changing the network configuration. When you first log in to the Web Control, use the user name "admin" and the password "rigol"..
7. The SCPI Panel Control function allows the user to send SCPI commands through the web interface for remote programming control of the instrument. Click **SCPI Panel Control** to enter the commands into the SCPI Command input field. After inputting the commands, click the **Send&Read** button to send the command and read the returned value.

You can program and control the instrument by using the SCPI (Standard Commands for Programmable Instruments) commands. For details about the SCPI

commands and programming, refer to *Programming Guide* of this series of product.

8. Close the browser to exit the instrument remote control interface.

Only one user can access the instrument IP address for remote control operation at a time. First come, first served. Concurrent logins are not allowed. If the connection is interrupted, you can refresh the browser to load the page.



CAUTION

Before setting up communication, please turn off the instrument to avoid causing damage to the communication interfaces.

23 Preset

Press  on the front panel to recall the preset settings and restores the system settings of the analyzer to factory defaults.

Parameter Name	Parameter Value
Trace	
Selected Trace	Trace 1
Trace Title	Off
Trace Hold	Off
Channel	
Selected Channel	Channel 1
Selected Window	Window 1
Window Title	Off
Selected Sheet	Sheet 1
Sheet Title	Sheet 1
Frequency	
Start Freq	10 MHz
Stop Freq	Related to the instrument model
Center Freq	Related to the instrument model
Span	Related to the instrument model
Sweep	
Sweep Points	201
Sweep Type	Linear Frequency
Delay Time	0 s
Auto Sweep State	Auto
Auto Dwell Time	0 s
Measure	
S-Parameter	S11
Parameter Conversion	Off
Data Format	Log Magnitude
Marker	
Selected Marker	Marker 1
Delta Marker	Off
Discrete	Off
Marker Table	Off
Marker Type	Normal
Show Marker Readout	On
Readouts Per Trace	5
Symbol	Triangle
Coupling Mode	Channel Coupled
Search	

Parameter Name	Parameter Value
Search Domain	Full Span
Search Tracking	Off
Peak	
Peak Threshold	-100 dB
Peak Excursion	3 dB
Peak Polarity	Positive
Target	
Target Value	0 dB
Target Transition	Both
Multi Peak & Target	
Multi Peak Threshold	-100 dB
Multi Peak Excursion	3 dB
Multi Peak Polarity	Positive
Multi Target Value	0 dBm
Multi Target Transition	Both
Power	
State	On
Signal Output Port	Port1
Port Power	-5 dBm
Avg BW	
IF BW	100 kHz
Averaging	
Averaging Enable	Off
Avg Number	1
Average Type	Sweep
Smoothing	
Smoothing Enable	Off
Smoothing Aperture	1%
Smoothing Points	3
Group Delay Aperture	
Percent of Span	5%
Number of Points	11
Frequency	424.5 MHz
Trigger	
Trigger Mode	Continuous
Trigger Source	Internal
Trigger Scope	Channel
Input	
Global Trigger Delay	0 s
Trigger Level/Edge	High Level
Output	

Parameter Name	Parameter Value
Enable	Off
Polarity	Negative pulse
Position	After Acquisition
Per Point	Off
Pulse Duration	1 μ s
Scale	
Scale	10 dB
Reference Level	0 dB
Reference Position	5
Electrical Delay	
Electrical Delay Time	0 s
Electrical Delay Distance	0 m
Distance Unit	Meter
Velocity Factor	0.66
Constant	
System Impedance	50 Ω
Phase Offset	0°
Magnitude Offset	0 dB
Magnitude Offset Slope	0 dB/GHz
Math Operation	
Data Math	Off
Display	Data Trace
Parameter Conversion	Off
Statistics	Off
Limit Test	
Enable	Off
Limit Line	Off
Limit Table	Off
Global Pass/Fail	Off
Global Pass/Fail Policy	All Tests
DTF	
DTF State	Off
Distance Unit	Meter
Stop Distance	0
Cable Loss	6.72 m
Velocity Factor	0.66
Window Function	Rectangular
Time Domain	
Transform State	Off
Start Time	-10 ns
Stop Time	10 ns

Parameter Name		Parameter Value
Center Time		0 s
Span Time		20 ns
Transform Type		Band Pass
Time Gating		
Gating State		Off
Start Time		-10 ns
Stop Time		10 ns
Center Time		0 s
Span Time		20 ns
Gate Type		Band Pass
Gate Shape		Normal
Time Domain Setup		
Coupling State		On
Marker Mode		Auto
Unit		Meter
Velocity Factor		0.66
Kaiser Beta		6.00
Impulse Width		227.701 ps
Calibration		
Correction		Off
Interpolation		Off
Port Extension		
Enable		Off
Delay		0 s
Distance		0 m
Distance Unit		Meter
Velocity Factor		0.66
Fixture		
Apply Fixture		Off
Port Match		Off
Port Z		Off
2-port DeEmbed		Off
Save/Recall		
Path		C:/data/UserData
System		
Language		English

24 Troubleshooting

1. When I power on the instrument, the instrument stays black and does not display anything.

- a. Check whether the power is correctly connected.
- b. Check the power key on the front panel, and ensure that LED light of at least one test connector is illuminated in green. This proves that the power key is enabled and works normally.
- c. Check whether the fuse is blown. If you need to replace the fuse, use only the specified fuse that conforms to the product.
- d. Restart the instrument after finishing the above inspections.
- e. If the problem still persists, contact RIGOL.

2. The USB storage device cannot be recognized.

- a. Check whether the USB storage device can work normally when connected to other instruments or PC.
- b. Make sure that the USB storage device is FAT32 format and flash type. The instrument doesn't support hardware USB storage device.
- c. After restarting the instrument, insert the USB storage device again to check whether it can work normally.
- d. If the problem still persists, contact RIGOL.

3. The touch functions cannot be used normally.

- a. Check whether you have locked the touch screen. If yes, unlock the touch screen.
- b. Check whether the screen or your finger is stained with oil or sweat. If yes, please clean the screen or dry your hands.
- c. Check whether there is a strong magnetic field around the instrument. If the instrument is close to the strong magnetic field (e.g. a magnet), please move the instrument away from the magnet field.
- d. If the problem still persists, contact RIGOL.

4. The user interface has not refreshed for a long time.

- a. Check whether the screen is locked or not. If yes, press Esc to unlock it.
- b. Check whether all the trigger conditions have been met and whether there is a valid trigger signal.

- c. Check whether the analyzer is in Stop state or in single trigger state.

5. The performance specifications test is failed.

- a. Check whether the instrument is within the calibration period.
- b. Ensure that you have warmed up the instrument for at least 40 minutes before test.
- c. Check whether the instrument is under the specified temperature.
- d. Check whether the test is under strong-magnetism environment.
- e. Check whether the power supplies of the instrument and the test system have a strong interference.
- f. Check whether the performance of the test device used meets the requirement.
- g. Make sure that the test device used is within the calibration period.
- h. Check whether the test devices used meets the required conditions of the manual.
- i. Check whether all the connections are tight.
- j. Check whether the instrument has connected other devices, cables, and connectors. If yes, check if they are properly connected and work normally.
- k. Make sure that the operations conform to settings and processes specified in the performance verification manual.
- l. If the instrument does not work well, press Preset to restore the system to its preset settings.
- m. Check whether the error calculation has faults.
- n. Correctly understand the definitions of "Typical", and "Nominal" values for this product.
 - Typical (typ.): typical performance, which 80 percent of the measurement results will meet at room temperature (approximately 25°C). The data are not warranted and do not include the measurement uncertainty.

- Nominal (nom.): the expected mean or average performance or a designed attribute (such as the 50Ω connector). The data are not warranted and are measured at room temperature (approximately 25°C).

25 Appendix

25.1 Appendix A: Options and Accessories

	Description	Order No.
Model	5 kHz to 8.5 GHz, 2 ports	DNA6082
	5 kHz to 8.5 GHz, 4 ports	DNA6084
	5 kHz to 14 GHz, 2 ports	DNA6142
	5 kHz to 14 GHz, 4 ports	DNA6144
	5 kHz to 20 GHz, 2 ports	DNA6202
	5 kHz to 20 GHz, 4 ports	DNA6204
	5 kHz to 26.5 GHz, 2 ports	DNA6262
	5 kHz to 26.5 GHz, 4 ports	DNA6264
Standard Accessory	Power Cord	-
Measurement Application Option	TDA (Time-Domain Analysis)	DNA-TDA10
	DTF (Distance to Fault)	DNA-DTF10
Optional Accessories	Electronic Calibration Kit, 100 kHz to 9 GHz, 2 ports, Type-N (F), 50 Ω	ECAL109-NF2
	Electronic Calibration Kit, 100 kHz to 14 GHz, 2 ports, Type-N (F), 50 Ω	ECAL114-NF2
	Electronic Calibration Kit, 100 kHz to 26.5 GHz, 3.5 mm (F), 2 ports	ECAL126-35F2
	4-in-1 OSLT Mechanical Calibration Kit, DC to 26.5 GHz, 3.5 mm (F)	MCAL226-35F5
Optional Accessories	Mechanical Calibration Kit, DC to 4.5 GHz, Type-N (M), 50 Ω	MCAL104-NM1
	Mechanical Calibration Kit, DC to 4.5 GHz, Type-N (F), 50 Ω	MCAL104-NF1

Mechanical Calibration Kit, DC to 9 GHz, Type-N (M), 50 Ω	MCAL109-NM1
Mechanical Calibration Kit, DC to 9 GHz, Type-N (F), 50 Ω	MCAL109-NF1
Mechanical Calibration Kit, DC to 9 GHz, Type-N (M & F), 50 Ω	MCAL109-NK1
Mechanical Calibration Kit, DC to 4.5 GHz, 3.5 mm (M)	MCAL104-SM1
Mechanical Calibration Kit, DC to 4.5 GHz, 3.5 mm (F)	MCAL104-SF1
Mechanical Calibration Kit, DC to 9 GHz, 3.5 mm (M)	MCAL109-SM1
Mechanical Calibration Kit, DC to 9 GHz, 3.5 mm (F)	MCAL109-SF1
Mechanical Calibration Kit, DC to 9 GHz, 3.5 mm (M & F)	MCAL109-SK1
Mechanical Calibration Kit, DC to 26.5 GHz, 3.5 mm (M & F)	MCAL126-35K1

NOTE

For all the mainframes, accessories, and options, please contact the local office of RIGOL.



25.2 Appendix B: Warranty

RIGOL TECHNOLOGIES CO., LTD. (hereinafter referred to as RIGOL) warrants that the product mainframe and product accessories will be free from defects in materials and workmanship within the warranty period. If a product proves defective within the warranty period, RIGOL guarantees free replacement or repair for the defective product.

To get repair service, please contact your nearest RIGOL sales or service office.

There is no other warranty, expressed or implied, except such as is expressly set forth herein or other applicable warranty card. There is no implied warranty of merchantability or fitness for a particular purpose. Under no circumstances shall RIGOL be liable for any consequential, indirect, ensuing, or special damages for any breach of warranty in any case.

Boost Smart World and Technology Innovation

Industrial Intelligent
Manufacturing



Semiconductors

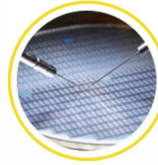

Education &
Research

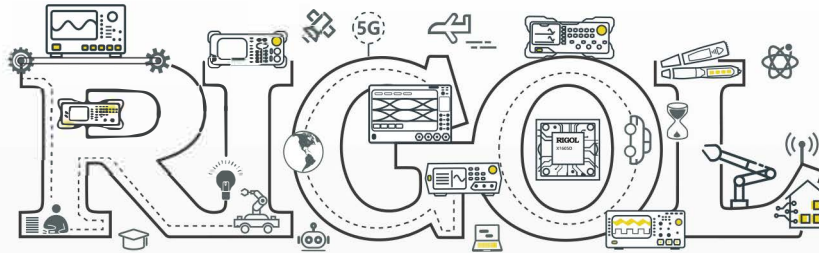

Communication

System Integration

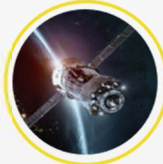

New Energy



- 5G Cellular-5G/WIFI
- UWB/RFID/ ZIGBEE
- Digital Bus/Ethernet
- Optical Communication

- Digital/Analog/RF Chip
- Memory and MCU Chip
- Third-Generation Semiconductor
- Solar Photovoltaic Cells

- New Energy Automobile
- PV/Inverter
- Power Test
- Automotive Electronics

*Provide Testing and Measuring Products
and Solutions for Industry Customers*

Distribution in the UK & Ireland



**Characterisation,
Measurement &
Analysis**

Lambda Photometrics Limited

Lambda House Batford Mill
Harpenden Herts AL5 5BZ
United Kingdom

E: info@lambdaphoto.co.uk

W: www.lambdaphoto.co.uk

T: +44 (0)1582 764334

F: +44 (0)1582 712084