



Test & Measurement Product Catalog



Distribution in the UK & Ireland



Lambda Photometrics Limited
Lambda House Batford Mill
Harpenden Herts AL5 5BZ
United Kingdom
E: info@lambdaphoto.co.uk
W: www.lambdaphoto.co.uk
T: +44 (0)1582 764334
F: +44 (0)1582 712084

RIGOL TECHNOLOGIES, INC.

Contents

Digital Oscilloscope	3
DS6000 Series Digital Oscilloscope	4
MSO/DS4000 Series Digital Oscilloscope	6
DS4000E Series Digital Oscilloscope	8
MSO/DS2000A Series Digital Oscilloscope	10
DS2000E Series Digital Oscilloscope	12
MSO/DS1000Z Series Digital Oscilloscope	14
DS1000B Series Digital Oscilloscope	16
DS1000D/E Series Digital Oscilloscope	16
Bus Analysis Guide	18
Power Measurement and Analysis	18
Current & Active Probes	19
Probes & Accessories Guide	20
Spectrum Analyzer	21
RSA5000 Series Spectrum Analyzer	22
DSA800/E Series Spectrum Analyzer	24
DSA700 Series Spectrum Analyzer	26
EMI Test System(S1210)	28
NFP-3 Near Field Probes	28
Common RF Accessories	29
RF Accessories Selection Guide	30
RF Signal Generator	31
DSG3000 Series RF Signal Generator	32
DSG800 Series RF Signal Generator	34
Function/Arbitrary Waveform Generator	36
DG5000 Series Function/Arbitrary Waveform Generator	37
DG4000 Series Function/Arbitrary Waveform Generator	39
DG1000Z Series Function/Arbitrary Waveform Generator	41
DG1000 Series Function/Arbitrary Waveform Generator	43
Digital Multimeter	44
DM3058 5½ Digits Digital Multimeter	44
DM3058E 5½ Digits Digital Multimeter	44
DM3068 6½ Digits Digital Multimeter	44
Data Acquisition/Switch System	46
M300 Series Data Acquisition/Switch System	48
Programmable DC Power Supply	48
DP800 Series Programmable DC Power Supply	49
DP700 Series Programmable DC Power Supply	51
Programmable DC Electronic Load	53
DL3000 Series Programmable DC Electronic Load	53

Digital Oscilloscope



Digital oscilloscope, an essential electronic equipment for R&D, manufacture and maintenance, is used by electronic engineers to observe various kinds of analog and digital signals.

RIGOL is a leading manufacturer and supplier of digital oscilloscope in China and has made many breakthroughs in the domestic industry. It introduces 5 generations of oscilloscopes since its creation. DS6000 series digital oscilloscope, the first DSO in China featuring 1GHz Bandwidth, was introduced in 2009.

By adopting the innovative technique “UltraVision”, DS6000 realizes deeper memory depth, higher waveform capture rate, real time waveform record and multi-level intensity grading display as well as other functions instead of Application Specific Integrated Circuits (ASIC).

Now RIGOL has developed several series of oscilloscopes (including DS1000D/E, DS1000B, MSO/DS1000Z, DS2000E, MSO/DS2000A, DS4000E, MSO/DS4000 , and DS6000) to meet different customer needs and to improve the testing efficiency.

Series	Analog Channels	Digital Channels (MSO)	Max. Sample Rate	Max. Memory Depth	Bus Analysis	Bandwidth Range(MHz)								
						1000	600	500	350	300	200	100	70	50
DS6000	2 / 4	--	5 Gsa/s	140 Mpts	●	●	●							
MSO/DS4000	2 / 4	16	4 Gsa/s	140 Mpts	●			●	●		●	●		
DS4000E	4	--	2 Gsa/s	14 Mpts	●						●	●		
MSO/DS2000A	2	16	2 Gsa/s	56 Mpts	●					●	●	●	●	
DS2000E	2	--	1 Gsa/s	28 Mpts	●						●	●		
MSO/DS1000Z	4	16	1 Gsa/s	24 Mpts	●							●	●	●
DS1000B	4	--	2 Gsa/s	16 Kpts							●	●	●	
DS1000D	2	16	1 Gsa/s	1 Mpts								●		●
DS1000E	2	--	1 Gsa/s	1 Mpts								●		●

● Standard or Option, could be supported.

DS6000 Series Digital Oscilloscope

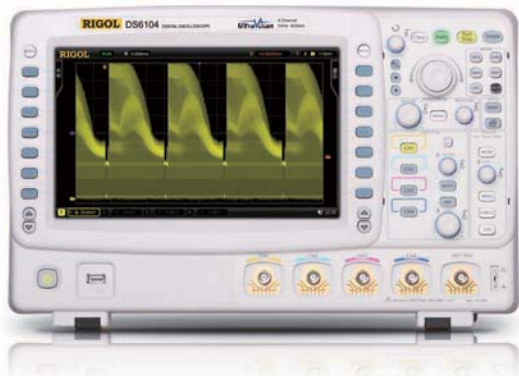

UltraVision



Innovative UltraVision technique

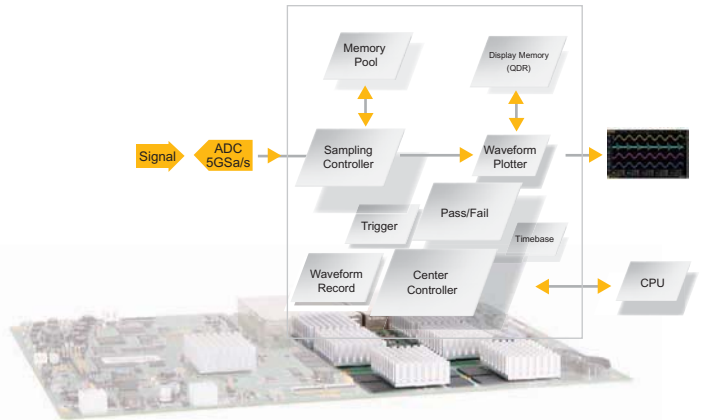

Key Features

DS6000 series digital oscilloscope provides up to 1GHz bandwidth, 5GSa/s sample rate. It has the deepest memory depth and fastest waveform capture rate of this class.

DS6000 series adopts many today's new technologies to achieve high performance, abundant features in the same class. It's designed to aim at the requirements of the largest digital oscilloscope market segment from the communications, semiconductor, computing, aerospace defense, instrumentation, research/education, industrial

electronics, consumer electronics and automotive industries with its innovative technology, industry leading specifications, powerful trigger functions and broad analysis capabilities.

- Up to 1 GHz or 600MHz bandwidth
- Standard 140Mpts deep memory
- Up to 180,000 waveforms per second capture rate
- Up to 200,000 frames for waveform record and replay
- Standard serial bus trigger and optional decode

Up to 180k Waveforms/s Waveform capture rate



Real time waveform Record, Replay & Analysis



Deeper Memory; Multi-Level intensity grading display

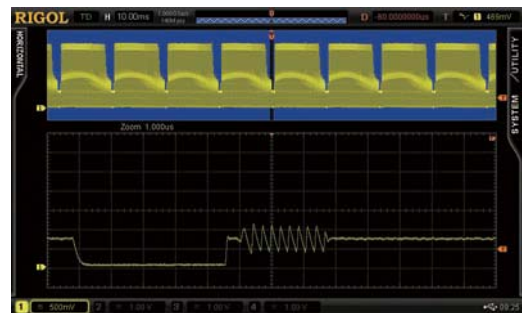

Standard trigger and Optional Decoding functions for Serial Bus

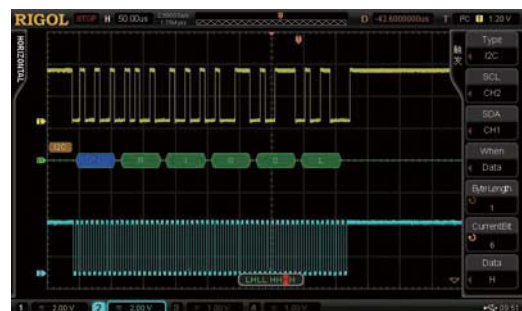

Key Specifications

Model	DS6104	DS6102	DS6064	DS6062
Analog BW	1GHz		600MHz	
Channels	4	2	4	2
Max. Sample rate	5 GSa/s			
Max. Memory Depth	140 Mpts (Std.)			
Max. Waveform Capture rate	180,000 wfms/s			
Time Base Accuracy	≤ ±4 ppm			
Time Base Drift	≤ ±2 ppm/Year			
Timebase Scale	500 ps/div to 50 s/div		1 ns/div to 50 s/div	
Input Impedance	1MΩ, 50 Ω			
Vertical Scale	2 mV/div to 5 V/div(1 MΩ) 2 mV/div to 1 V/div(50 Ω)			
DC Gain Accuracy	±2% full scale			
Bandwidth Limit	20 MHz or 250 MHz			
Real Time waveform Record, Replay and Analysis function	Max. 200,000 frames(Std.)			
Std, trigger functions	Edge, Pulse width, Slope, Video, HDTV, Pattern, RS232, I2C, SPI, CAN, USB, FlexRay			
Serial Bus decoding	RS232, I2C, SPI, CAN, FlexRay			
Math functions	A+B, A-B, A×B, A/B, FFT, Advanced Math, Logic operation			
Auto Measurements	Vpp, Vamp, Vmax, Vmin, Vtop, Vbase, Vavg, Vrms,Area,Period Area, Overshoot, Preshoot, Freq, Period, Rise Time, Fall Time, +Width, -Width, +Duty, -Duty, Delay A→B rising edge, Delay A→B falling edge, Phase A→B rising edge,Phase A→B falling edge			
Connectivities	Dual USB HOST, USB DEVICE, LAN, VGA, 10MHz Input/Output, Aux Output(TrigOut, Quick Edge, PassFail, Calibration, GND)			
Display	10.1 inches WVGA(800X480) TFT LCD display, 256 intensity grading level			
Size (W×H×D)	399.0 mm× 255.3 mm×123.8 mm			
Weight	5.345 ± 0.2 kg			

Ordering Information

	Description	Order Number
Model	DS6104 (1GHz, 5GSa/s, 140Mpts, 4-channel)	DS6104
	DS6102 (1GHz, 5GSa/s, 140Mpts, 2-channel)	DS6102
	DS6064 (600MHz, 5GSa/s, 140Mpts, 4-channel)	DS6064
	DS6062 (600MHz, 5GSa/s, 140Mpts, 2-channel)	DS6062
Standard Accessories	600MHz passive probe x 4 (for DS6104 and DS6064) 600MHz passive probe x 2 (for DS6102 and DS6062)	RP5600A
	1.5GHz passive probe x 2 (for DS6104) 1.5GHz passive probe x 1 (for DS6102)	RP6150A
	USB Cable	CB-USBA-USBB-FF-150
	Front Panel Cover	FPCS-DS6000
	Power Cord	-
	Quick Guide	-

For probes and optional accessories please refer to "Probes and Accessories Guide".

For decoding options please refer to "Bus Analysis Guide".

MSO/DS4000 Series Digital Oscilloscope



UltraVision

MSO/DS4000 series is high performance oscilloscope with 100MHz ~ 500MHz bandwidth and up to 4GSa/s sample rate. They also provide deep memory depth and high waveform capture rate. MSO/DS4000 Series is the new mainstream digital scope to meet the customer's applications with its innovative technology, industry leading specifications, powerful trigger functions and broad analysis capabilities.

- Bandwidth 500MHz, 350MHz, 200MHz, 100MHz
- Bandwidth Upgradable
- Real-time sample rate up to 4GSa/s
- Standard Memory depth: Analog channel up to 140Mpts, Digital Channel up to 28Mpts
- Real Time Waveform Record, Replay & Analysis (Std. up to 200,000 frames)
- Support serial bus trigger and decoding
- 9 inch WVGA (800X480), 256-level intensity grading display

Up to 110k Waveforms/s Waveform capture rate



Realtime waveform record, replay, analysis function (std.)



Deeper Memory with 256-Level intensity grading display



Mixed Signal Analysis with analog and digital channels



Serial bus Triggering and Decoding (Support both Analog and Digital channels)

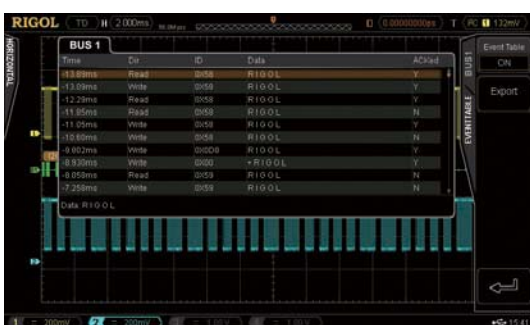

Serial bus triggering and decoding on digital channels

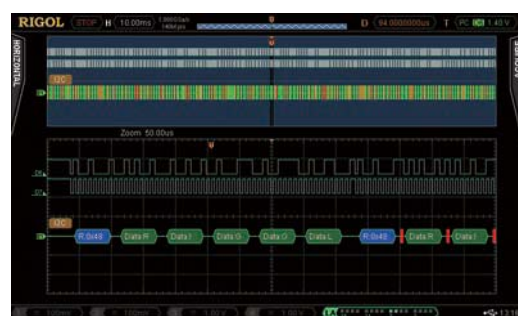

Key Specifications

Model	DS4054 MSO4054	DS4052 MSO4052	DS4034 MSO4034	DS4032 MSO4032	DS4024 MSO4024	DS4022 MSO4022	DS4014 MSO4014	DS4012 MSO4012
Analog BW	500MHz		350MHz		200MHz		100MHz	
Analog Channels	4	2	4	2	4	2	4	2
Digital Channels(MSO)	16 (support group operations)							
Max. Sample rate	Analog Channel: Max. 4GSa/s half channel, 2GSa/s per channel; Digital Channel: Max. 1GSa/s per channel							
Max. Memory Depth	Analog Channel: Std. up to 140Mpts half channel,70Mpts per channel Digital Channel: Std. up to 28Mpts per channel (only MSO)							
Max. Waveform Capture rate	DS: 110,000wfms/s; MSO: 110,000wfms/s (digital channel off); 85,000wfms/s (digital channel on)							
Timebase Scale	1ns/div to 1000s/div		2ns/div to 1000s/div			5ns/div to 1000s/div		
Input Impedance	Analog channel: (1MΩ±1%) (14 pF±3 pF) or 50 Ω±1.5%; Digital channel: (101 kΩ±1%) (9 pF ± 1 pF)							
Vertical Scale	1 mV/div to 5 V/div (1 MΩ); 1 mV/div to 1 V/div (50 Ω) Threshold per set of 8 channels, User-defined threshold range ±20V in 10mV step							
DC Gain Accuracy	±2% full scale							
Real Time waveform Record and Analysis	Analog channel: Up to 200,000 frames(Std.) Digital channel: Up to 64,000 frames(Std.)							
Trigger functions	Std:Edge, Pulse width, Runt, Nth Edge, Slope, Video, HDTV, Pattern,RS232/UART,I2C,SPI,CAN,USB,FlexRay; Opt:LIN							
Serial Bus decoding	Standard: Parallel; Optional: RS232/UART, I2C, SPI, CAN, LIN, FlexRay (analog and digital channel)							
Math functions	Analog channel: A+B, A-B, A×B, A/B, FFT,Digital Filter, Advanced Math, Logic operation; Digital channel: Logic operation							
Auto Measurements	Analog channel: 29 types; Digital channel: 12 types							
Connectivity	USB Host, USB Device, LAN, VGA, AUX, 10MHz input/output							
Display	9.0 inches WVGA(800X480) TFT LCD display, 256 intensity grading level							

Ordering Information

	Description	Order Number
Model	DS4012 (100 MHz, 4 GSa/s, 140 Mpts, 2-channel)	DS4012
	DS4014 (100 MHz, 4 GSa/s, 140 Mpts, 4-channel)	DS4014
	DS4022 (200 MHz, 4 GSa/s, 140 Mpts, 2-channel)	DS4022
	DS4024 (200 MHz, 4 GSa/s, 140 Mpts, 4-channel)	DS4024
	DS4032 (350 MHz, 4 GSa/s, 140 Mpts, 2-channel)	DS4032
	DS4034 (350 MHz, 4 GSa/s, 140 Mpts, 4-channel)	DS4034
	DS4052 (500 MHz, 4 GSa/s, 140 Mpts, 2-channel)	DS4052
	DS4054 (500 MHz, 4 GSa/s, 140 Mpts, 4-channel)	DS4054
	MSO4012 (100 MHz, 4 GSa/s, 140 Mpts, 2+16 channels MSO)	MSO4012
	MSO4014 (100 MHz, 4 GSa/s, 140 Mpts, 4+16 channels MSO)	MSO4014
	MSO4022 (200 MHz, 4 GSa/s, 140 Mpts, 2+16 channels MSO)	MSO4022
	MSO4024 (200 MHz, 4 GSa/s, 140 Mpts, 4+16 channels MSO)	MSO4024
	MSO4032 (350 MHz, 4 GSa/s, 140 Mpts, 2+16 channels MSO)	MSO4032
	MSO4034 (350 MHz, 4 GSa/s, 140 Mpts, 4+16 channels MSO)	MSO4034
	MSO4052 (500 MHz, 4 GSa/s, 140 Mpts, 2+16 channels MSO)	MSO4052
	MSO4054 (500 MHz, 4 GSa/s, 140 Mpts, 4+16 channels MSO)	MSO4054
Standard Accessories	2 or 4 500MHz passive probe	RP3500A
	1 Set logic analysis probe (MSO models)	RPL2316
	USB Cable	CB-USBA-USBB-FF-150
	Front Panel Cover	FPCS-DS4000
	Power Cord	-
Bandwidth Update Option	Quick Guide	-
	Bandwidth upgrade from 200 MHz to 350 MHz for MSO/DS402x	BW2T3-MSO/DS4000
	Bandwidth upgrade from 200 MHz to 500 MHz for MSO/DS402x	BW2T5-MSO/DS4000
Optional kit	Bandwidth upgrade from 350 MHz to 500 MHz for MSO/DS403x	BW3T5-MSO/DS4000
	Including:SD-AUTO-DS4000,SD-FlexRay-DS4000,SD-I2C/SPI-DS4000, SD-RS232-DS4000	BND-MSO/DS4000

For probes and optional accessories please refer to "Probes & Accessories Guide".

For decoding options please refer to "Bus Analysis Guide".

DS4000E Series Digital Oscilloscope



UltraVision

DS4000E series is high performance and economy general oscilloscope which provides bandwidth from 100MHz to 200MHz, up to 2GSa/s sample rate per channel, and up to 14Mpts memory depth all four channels. It is designed for the needs of the design, debugging and testing of the most widely used digital oscilloscope market.

- Bandwidth 100MHz, 200MHz
- Real-time sample rate up to 2GSa/s per channel
- Standard memory depth up to 14Mpts per channel
- Standard with 4 analog channels
- Real Time Waveform Record, Replay & Analysis (Std. up to 127,000 frames)
- Support serial bus trigger (Std.) and decoding (Opt.)
- 9 inch WVGA (800×480), 256-level intensity grading display

Up to 60,000 wfms/s Waveform capture rate



Standard with 4 analog channels



Deeper memory per channel (Std. 14Mpts)



Real-time waveform record, replay, analysis function (Std.)

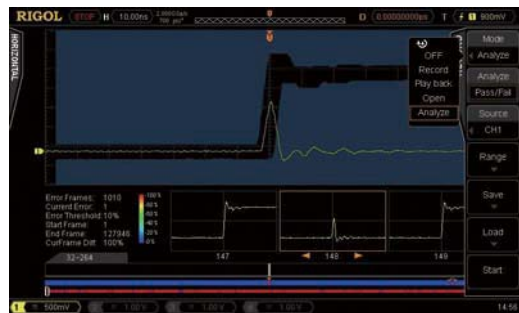

Support serial bus trigger (Std.) and decoding (Opt.)

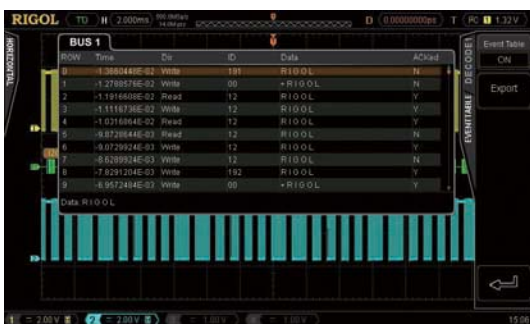

Standard mask test function



Key Specifications

Model	DS4024E	DS4014E
Analog BW	200MHz	100MHz
Channels (DS)	4	
Sample rate(Scope channel)	Max. 2GSa/s per channel	
Memory Depth(Scope channel)	Std. up to 14 Mpts per channel	
Waveform Capture rate	Max. 60,000 wfms/s	
Time Base Accuracy	$\leq \pm 4$ ppm	
Time Base Drift	$\leq \pm 2$ ppm/Year	
Timebase Scale	2 ns/div to 1 ks/div	5 ns/div to 1 ks/div
Input Impedance	(1 M Ω \pm 1%) (15 pF \pm 3 pF) or 50 Ω \pm 1.5%	
Vertical Scale	1 mV/div to 5 V/div (1M Ω) or 1 mV/div to 1 V/div (50 Ω)	
DC Gain Accuracy	\pm 2% full scale	
Bandwidth Limit	20 MHz/100MHz	20 MHz
Real Time waveform Record, Replay and Analysis function	Max. 127,000 frames(Std.)	
Trigger functions	Std:Edge, Pulse width, Runt, Nth Edge, Slope, Video, HDTV, Pattern,RS232/UART,I2C,SPI,CAN,USB,FlexRay; Opt:LIN	
Serial Bus decoding	Standard: Parallel;Option: RS232,I2C,SPI,CAN,LIN,FlexRay	
Math functions	Analog channel: A+B,A-B,A \times B,A/B,FFT,Digital Filter,Advanced Math,Logic operation	
Auto Measurements	29 types	
Connectivities	USB Host, USB Device, LAN, VGA, AUX, 10MHz input/output	
Display	9.0 inches WVGA(800X480) TFT LCD display,256 intensity grading level	
Size(W \times H \times D)	440.0 mm \times 218.0 mm \times 130.0 mm	
Weight	4.8 kg \pm 0.2 kg	

Ordering Information

	Description	Order Number
Model	DS4014E (100 MHz, 2 GSa/s, 14 Mpts, 4-channel)	DS4014E
	DS4024E (200 MHz, 2 GSa/s, 14 Mpts, 4-channel)	DS4024E
Standard Accessories	4 Passive Probes (1X:35MHz/10X:350MHz BW)	PVP2350
	USB Data Cable	CB-USBA-USBB-FF-150
	Front Panel Cover	FPC-DS4000
	Power Cord conforming to the standard of the destination country	-
	Quick Guide (Hard Copy)	-
Optional kit	Including:SD-AUTO-DS4000,SD-FlexRay-DS4000,SD-I2C/SPI-DS4000,SD-RS232-DS4000	BND-MSO/DS4000

For probes and optional accessories please refer to "Probes & Accessories Guide".

For decoding options please refer to "Bus Analysis Guide".

MSO/DS2000A Series Digital Oscilloscope

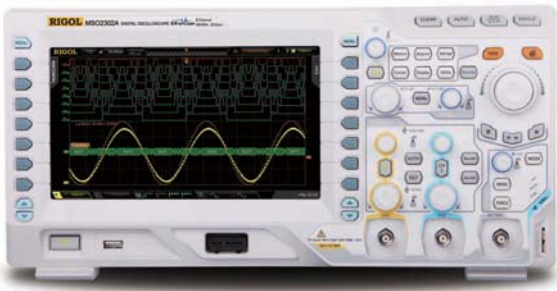

MSO/DS2000A Series is the new mainstream digital scope to meet the customer's applications with its innovative technology. It provides bandwidth from 70MHz to 300MHz, sample rate up to 2GSa/s, and 2+16 channels, targeting for the embedded design and test market with its industry leading specifications, powerful trigger functions and broad analysis capabilities.

- Bandwidth up to 300MHz, standard with 50Ω input
- Two analog channels and 16 digital channels (MSO)
- Lower noise floor, wider vertical range (500uV/div ~ 10V/div)
- Waveform capture rate up to 50,000 wfms/s
- Built-in 2 CH and 25MHz Waveform generator (-S model)
- A variety of trigger and serial bus decoding functions

Wider Vertical range, Lower noise floor, Better for small signal capturing



Serial bus Trigger&Decoding functions



Realtime waveform record, replay, analysis function (std.)



Easy to be grouped and labeled for digital channels



256 level intensity grading display



Built-in 2CH and 25MHz Source (-S model)

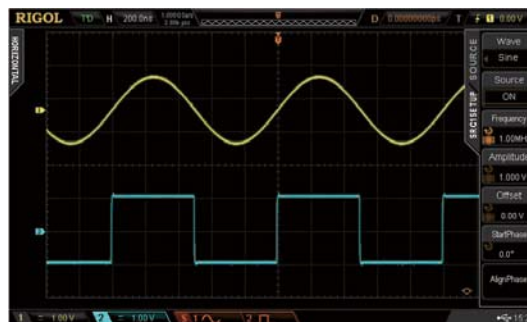

Key Specifications

Model	DS2302A	DS2302A-S	DS2202A	DS2202A-S	DS2102A	DS2102A-S	DS2072A	DS2072A-S
	MSO2302A	MSO2302A-S	MSO2202A	MSO2202A-S	MSO2102A	MSO2102A-S	MSO2072A	MSO2072A-S
Analog BW	300MHz		200MHz		100MHz		70MHz	
Analog Channels	2							
Digital Channels	16 (only MSO)							
Sample rate	Analog Channel: Max. 2 GSa/s single channel, 1 GSa/s dual channel; Digital Channel: 1GSa/s(8 CH), 500MSa/s(16 CH)							
Memory Depth	Analog channel: 7Mpts(2 CH) / 14Mpts(1 CH) std.;28Mpts(2 CH) / 56Mpts(1 CH) opt. ; Digital channel: 7Mpts(16 CH) / 14Mpts(8 CH) std.;14Mpts(16 CH) / 28Mpts(8 CH) opt.							
Waveform Capture rate	50,000wfms/s							
Timebase Scale	1ns/div to 1000s/div		2ns/div to 1000s/div		5ns/div to 1000s/div			
Input Impedance	Analog channel: (1MΩ±1%) (16 pF±3 pF) or 50Ω±1.5%; Digital channel: (101kΩ±1%) (8 pF±2 pF)							
Vertical Scale	Analog channel: 500 uV/div to 10 V/div(1 MΩ); 500 uV/div to 1 V/div(50 Ω); Digital channel: Threshold per set of 8 channels, User-defined threshold range ±20V in 10mV step							
DC Gain Accuracy	±2% full scale							
Waveform Record	Up to 65, 000 Frames							
Std. trigger functions	Edge, Pulse width, Runt, Slope, Video, Pattern, Setup/Hold, RS232/UART,I2C,SPI							
Opt. trigger functions	Windows, Nth Edge, HDTV, Delay, Time Out, Duration, USB, CAN							
Serial Bus decoding	Standard : Parallel Bus (only MSO) ; Optional: RS232/UART, I2C, SPI, CAN							
Math functions	Analog channel: A+B,A-B,A×B,A/B,FFT,Digital Filter,Advanced Math,Logic operation;Digital channel: Logic operation							
Auto Measurements	Analog channel: 29 types; Digital channel: 12 types							
Connectivity	USB Host, USB Device, LAN (LXI) , AUX, support USB-GPIB (Opt.)							
Display	8.0 inches WVGA(800X480) LCD display, 256 intensity grading level							
Built in 2CH 25MHz Function/Arb Generator (MSO/DS2xx2A-S)								
Channels	Sample Rate	Vertical Resolution	Max. Output Frequency	Amplitude Range	Waveform Length	Output Waveforms		
2	200MSa/s	14bits	25MHz	20mVpp-5Vpp (High Z)	16K	Standard Waveforms: Sine, Square, Ramp, Pulse, Noise, DC Arbitrary Waveforms: Sinc, ExpRise, ExpFall, ECG, Gauss, Lorentz, Haversine ,User Defined		

Ordering Information

	Description	Order Number
Model	DS2072A (70MHz, 2CH Scope)	DS2072A
	DS2072A-S (70MHz, 2CH Scope + 25MHz, 2CH Source)	DS2072A-S
	MSO2072A (70MHz, 2+16 CH MSO)	MSO2072A
	MSO2072A-S (70MHz, 2+16 CH MSO + 25MHz, 2CH Source)	MSO2072A-S
	DS2102A (100MHz, 2CH Scope)	DS2012A
	DS2102A-S (100MHz, 2CH Scope + 25MHz, 2CH Source)	DS2012A-S
	MSO2102A (100MHz, 2+16 CH MSO)	MSO2012A
	MSO2102A-S (100MHz, 2+16 CH MSO + 25MHz, 2CH Source)	MSO2012A-S
	DS2202A (200MHz, 2CH Scope)	DS2022A
	DS2202A-S (200MHz, 2CH Scope + 25MHz, 2CH Source)	DS2022A-S
	MSO2202A (200MHz, 2+16 CH MSO)	MSO2022A
	MSO2202A-S (200MHz, 2+16 CH MSO + 25MHz, 2CH Source)	MSO2022A-S
	DS2302A (300MHz, 2CH Scope)	DS2302A
	DS2302A-S (300MHz, 2CH Scope + 25MHz, 2CH Source)	DS2302A-S
	MSO2302A (300MHz, 2+16 CH MSO)	MSO2302A
	MSO2302A-S (300MHz, 2+16 CH MSO + 25MHz, 2CH Source)	MSO2302A-S
Standard Accessories	2 Passive probes (1X:35MHz / 10X:350MHz BW)	PVP2350
	1 Set LA probe(MSO only)	RPL2316
	Power Cord	-
	USB Cable	CB-USBA-USBFF-150
	Quick Guide (Hard Copy)	-
Deep Memory Option	Analog channel memory Depth upgraded up to 56Mpts Digital channel(MSO) memory Depth upgraded up to 28Mpts	MEM-DS2000
Advanced Trigger Option	Windows, Nth Edge, HDTV, Delay, Time Out, Duration, USB	AT-DS2000
Optional kit	Including:MEM-DS2000, AT-DS2000, SD-DS2000, CAN-DS2000A	BND-MSO/DS2000A

For probes and optional accessories please refer to "Probes & Accessories Guide".

For decoding options please refer to "Bus Analysis Guide".

DS2000E Series Digital Oscilloscope

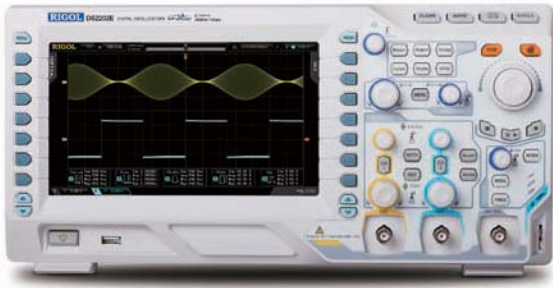

UltraVision

Engineers and technicians needing higher performance test solutions for more advanced debug tasks will appreciate the unique price/performance attributes of the DS2000E. Based on our UltraVision technology the DS2000E delivers advanced performance and analysis capabilities, a large intensity graded display, and a proven and reliable hardware platform at an unprecedented price point.

- 100 MHz and 200 MHz bandwidth models
- 2 analog channels, 50 Ω input impedance (standard)
- Vertical range: 500 μ V/div ~ 10 V/div
- Real-time sample rate: up to 1 GSa/s on each channels
- Memory depth: up to 28 Mpts on eachchannels
- Waveform capture rate: up to 50,000 wfms/s
- Real-time hardware waveform recording, playback, and analysis of up to 65,000 captured frames
- Various serial trigger and decode (RS232/UART, I2C, SPI and CAN)
- Complete connectivity: USB DEVICE, USB Host, LAN, and optional GPIB
- 8-inch WVGA (800 \times 480), 256-level intensity grading display

Wide range (500 μ V/div~10 V/div), low noise floor, clearly capture the low-level signals

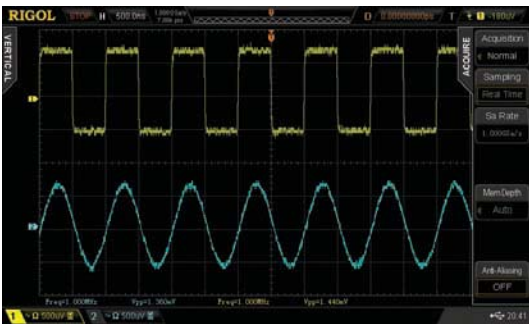

Waveform capture rate up to 50,000 wfms/s



High memory depth up to 28 Mpts on each Channels

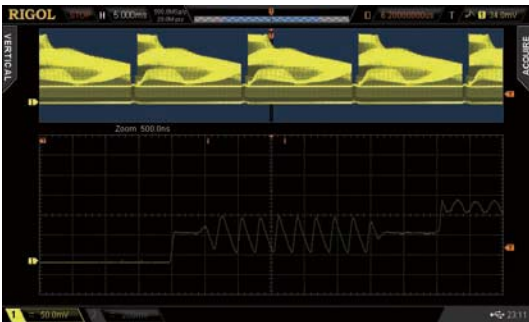

8 inch LCD, 256-level intensity grading display



Real-time and ceaseless waveform recording, playback, and analysis functions



Abundant advanced triggering functions (e.g. Runt Trigger, Setup/Hold Trigger, and Nth Edge Trigger)

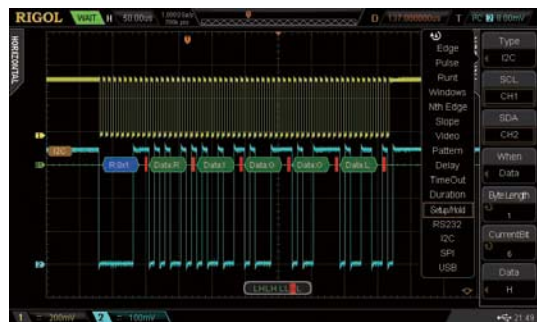

Key Specifications

Model	DS2202E	DS2102E
Analog BW	200 MHz	100 MHz
Analog Channels	2	
Max. sample rate	1 GSa/s on each channels	
Max. memory Depth	28 Mpts/CH	
Waveform Capture rate	Up to 50,000 wfms/s	
Timebase Scale	2 ns/div to 1 ks/div	5 ns/div to 1 ks/div
Input Impedance	(1MΩ±1%) (16 pF±3 pF) or 50Ω±1.5%	
Vertical Scale	500uV/div to 10V/div (1MΩ); 500uV/div to 1V/div (50Ω)	
DC Gain Accuracy	±2% full scale	
Waveform Record	Up to 65, 000 Frames	
Std. trigger functions	Edge, Pulse width, Runt, Slope, Video, Pattern, Setup/Hold, RS232/UART,I2C,SPI	
Opt. trigger functions	Windows, Nth Edge, HDTV, Delay, Time Out, Duration, USB, CAN	
Serial Bus decoding	Standard: Parallel Bus; Optional: RS232/UART, I2C, SPI, CAN	
Math functions	A+B, A-B, A×B, A/B, FFT, Digital Filter, Advanced Math, Logic operation	
Auto Measurements	29 measurement parameters, up to 5 measurement items can be enabled at the same time	
Connectivity	USB Host, USB Device, LAN(LXI) , AUX, support USB-GPIB(Opt.)	
Display	8.0-inch WVGA(800X480) LCD display, 256 intensity grading level	

Ordering Information

	Description	Order No.
Model	DS2102E (100 MHz, 2 analog channels)	DS2102E
	DS2202E (200 MHz, 2 analog channels)	DS2202E
Standard Accessories	Power Cord conforming to the standard of the destination country	-
	USB Cable	CB-USBA-USBB-FF-150
	2 Passive Probes (BW: 350 MHz)	PVP2350
	Quick Guide (hard copy)	-
Optional Accessories	Rack Mount Kit	RM-DS2000A
	Passive Probe (500 MHz)	RP3500A
	USB-GPIB Interface Converter	USB-GPIB
	A Portable Bag	BAG-G1
High Mem Depth Option	28 Mpts/CH memory (offering the official option for free)	-
Advanced Trigger Option	Windows Trigger, Nth Edge Trigger, Delay Trigger, TimeOut Trigger, Duration Trigger, USB Trigger	AT-DS2000A
Decoding Options	RS232/UART, I2C, SPI Decoding Kit	SD-DS2000A
	CAN Protocol Analysis Kit (Trigger + Decoding)	CAN-DS2000A
Bundle Option	Include all the advanced trigger options and decoding options	BND-DS2000A

Note: For all the accessories and options, please contact the local office of **RIGOL**

MSO/DS1000Z Series Digital Oscilloscope



UltraVision

MSO/DS1000Z Series is the high performance, economic level general purpose oscilloscope which provides 4 analog channels, the bandwidth from 50MHz to 100MHz, up to 1GSa/s sample rate, MSO models provides 4+16 channels. It is the new 4 channels mainstream digital oscilloscope to meet the customer's applications with RIGOL's innovative technology "UltraVision". The -PLUS models are MSO function ready, it could be upgraded to MSO with simply add the RPL1116 logic probe set.

- Analog channel Bandwidth: 100MHz, 70MHz, 50MHz
- 4 analog channels, 16 digital channels (MSO)
- Memory depth up to 12 Mpts (standard)/24 Mpts (optional)
- Various trigger and bus decoding functions
- Built-in dual-channel 25 MHz source (-S model)
- Various interfaces: USB, LAN (LXI), AUX, GPIB (optional)

Standard with 4 analog channels



Optional Serial Bus trigger and decoding functions

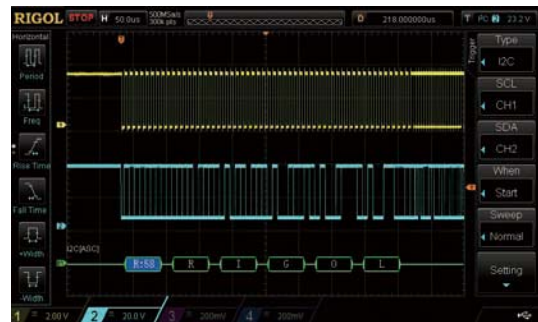

Intensity graded color display

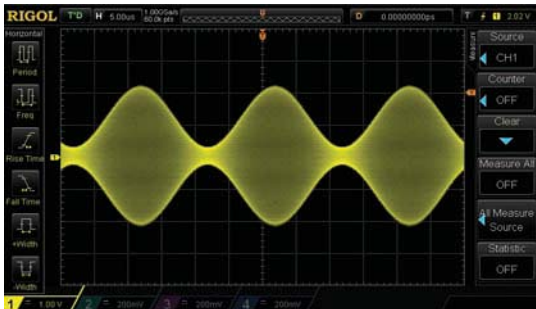

Mixed Signal Analysis with analog and digital channels

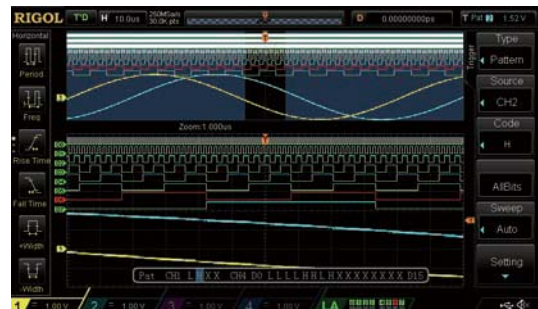

Deeper memory (Std. 12Mpts, Opt. 24Mpts)



Built-in dual-channel 25 MHz source (-S model)

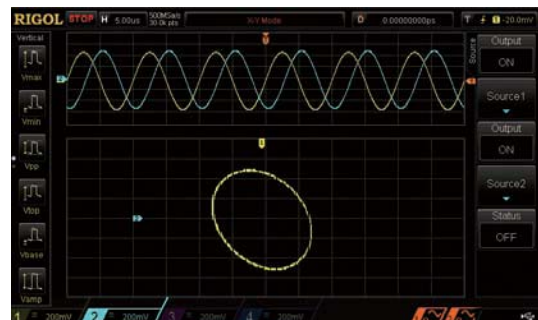

Key Specifications

Model	DS1104Z DS1104Z-S	DS1104Z Plus DS1104Z-S Plus	MSO1104Z MSO1104Z-S	DS1074Z DS1074Z-S	DS1074Z Plus DS1074Z-S Plus	MSO1074Z MSO1074Z-S	DS1054Z
Analog BW	100MHz			70MHz			50MHz
Analog Channels	4						
Digital Channels(MSO)	--	16		--	16		--
Max. Sample rate	Analog Channel:1GSa/s (1 CH),500MSa/s(2 CH),250MSa/s (3/4 CH); Digital Channel:1GSa/s (8 CH),500MSa/s(16 CH)						
Max. Memory Depth	Analog Channel: 12Mpts(1 CH), 6Mpts (2 CH), 3Mpts (3/4 CH)Std.; 24Mpts(1 CH), 12Mpts (2 CH), 6MptsV3/4 CH) Opt. Digital Channel: 12Mpts(8 CH) / 6Mpts(16 CH) Std.; 24Mpts(8 CH) / 12Mpts(16 CH) Opt.						
Max. Waveform Capture rate	30,000 wfms/s						
Timebase Scale	5 ns/div to 50 s/div						
Input Impedance	Analog Channel:(1MΩ±2%)(13 pF±3 pF); Digital Channel:(100kΩ±1%)(8 pF±3 pF)						
Vertical Scale	Analog Channel: 1 mV/div to 10 V/div Digital Channel: Threshold per set of 8 channels, User-defined threshold range ±15V in 10mV step						
DC Gain Accuracy	<10 mV: ±4% full scale ; ≥ 10 mV: ±3% full scale						
Real Time waveform Record and Analysis	Up to 60, 000 Frames(Opt.)						
Std. trigger functions	Edge, Pulse, Slope, Video, Pattern, Duration,						
Opt. trigger functions	Runt, Window, Nth Edge, Delay, Timeout, Setup/Hold, RS232/UART, I2C, SPI						
Bus decoding	Std: Parallel; Opt: RS232/UART,I2C,SPI						
Math functions	A+B, A-B, A×B, A/B, FFT, A&&B, A B, A^B, !A, Intg, Diff, Sqrt, Lg, Ln, Exp, Abs, Filter						
Auto Measurements	37 types						
Connectivity	USB Host (support USB-GPIB), USB Device, LAN(LXI), AUX (TrigOut/PassFail)						
Display	7.0 inch WVGA(800×480) TFT LCD display,64 intensity grading level						
MSO/DS1xx4Z-S and DS1xx4Z-S Plus, 25MHz Function/Arbitrary Waveform Generator							
Channels	Max. Sample Rate	Vertical Resolution	Max. Frequency	Amplitude Output Range	Waveform Length	Output Waveforms	
2	200MSa/s	14bits	25MHz	20mVpp-5Vpp (High Z)	16K	Sine,Square,Ramp,Pulse,Noise,DC,Sinc,Exponential Rise,Exponential Fall,ECG,Gauss,Lorentz,Haversine, User defined	

Ordering Information

	Description	Order Number
Model	DS1054Z (50 MHz, 4 CH)	DS1054Z
	DS1074Z/DS1074Z Plus (70 MHz, 4 CH; MSO only available for Plus model)	DS1074Z/DS1074Z Plus
	DS1074Z-S/DS1074Z-S Plus (70 MHz, 4 CH, 2-ch 25 MHz source; MSO only available for Plus model)	DS1074Z-S/DS1074Z-S Plus
	MSO1074Z (70 MHz, 4+16 CH)	MSO1074Z
	MSO1074Z-S (70 MHz, 4+16 CH, 2-ch 25 MHz source)	MSO1074Z-S
	DS1104Z/DS1104Z Plus (100 MHz, 4 CH; MSO only available for Plus model)	DS1104Z/DS1104Z Plus
	DS1104Z-S/DS1104Z-S Plus (100 MHz, 4 CH, 2-ch 25 MHz source; MSO only available for Plus model)	DS1104Z-S/DS1104Z-S Plus
	MSO1104Z (100 MHz, 4+16 CH)	MSO1104Z
	MSO1104Z-S (100 MHz, 4+16 CH, 2-ch 25 MHz source)	MSO1104Z-S
Standard Accessories	Power Cord	-
	USB Cable	CB-USBA-USBB-FF-150
	Quick Guide (Hard Copy)	-
	4 Passive Probes (1X:35MHz / 10X:150MHz BW)	PVP2150
	1 Set LA Probe (MSO only)	RPL1116
MSO Upgrade option	MSO upgrade package for DS1000Z Plus only, including logic analyzer probe(RPL1116) and model labe	MSO1000Z Upgrade Package
Deep Memory Option	Analog channel: 24 Mpts (single channel)/12 Mpts (dual-channel)/6 Mpts (three/four channel); Digital channel: 24 Mpts (8-channel)/12 Mpts (16-channel)	MEM-DS1000Z
Waveform Record Option	This option provides the waveform recording and playback function.	REC-DS1000Z
Advanced Trigger Option	RS232/UART trigger, I2C trigger, SPI trigger, Runt trigger, Window trigger, Nth edge trigger, delay trigger, timeout trigger, Setup/Hold trigger	AT-DS1000Z
Serial Protocol Analysis Option	RS232/UART, I2C and SPI trigger and decoding functions	SA-DS1000Z

For probes and optional accessories, please refer to "Probes & Accessories Guide".

For decoding options, please refer to "Bus Analysis Guide".

DS1000B Series Digital Oscilloscope

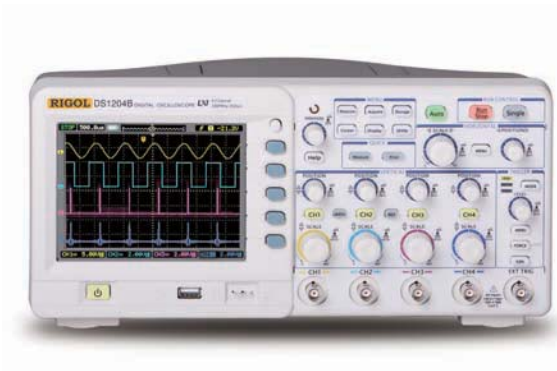

DS1000B series products are four-channel plus an external trigger oscilloscopes which can capture multi-channel signals at the same time to meet the industrial needs.

- Four analog channels
- 2GSa/s real-time sample rate
- Abundant trigger types: edge, video, pulse width, alternate and pattern trigger
- Waveform record and playback
- Standard with Pass/Fail test function
- Standard interfaces: USB Host & Device, LAN(LXI), support PictBridge

4 independent analog signals channels

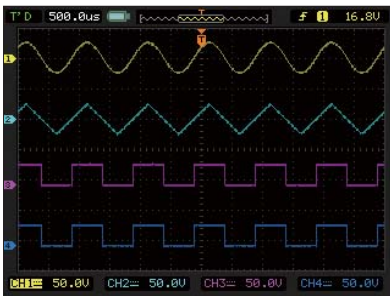

Standard with Pass/Fail test

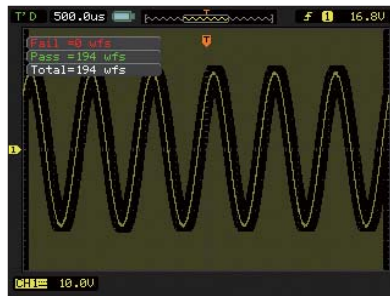

Advanced pattern trigger

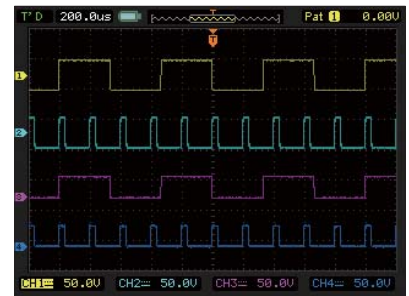

DS1000D/E Series Digital Oscilloscope

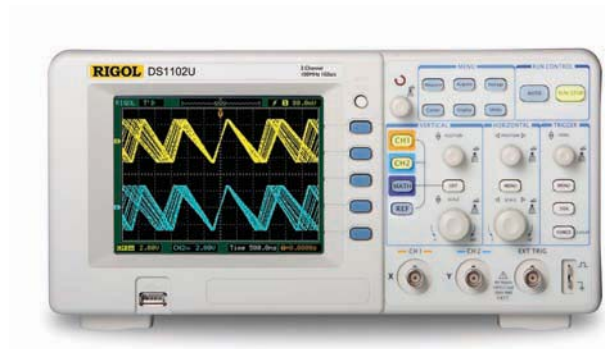

DS1000D/E series are the high-performance, economic digital oscilloscopes. They are widely used in the areas of education, training, production line, research and development. DS1000D series provide 2 analog channels plus 16 logic channels to meet mixed signal debug.

- 1GSa/s maximum real-time sample rate
- Up to 1Mpts Memory depth
- Abundant trigger types: edge, pulse width, slope, video, alternate, pattern (DS1000D) and duration (DS1000D)
- Standard with Pass/Fail test
- Compact and portable

1 Mpts memory depth

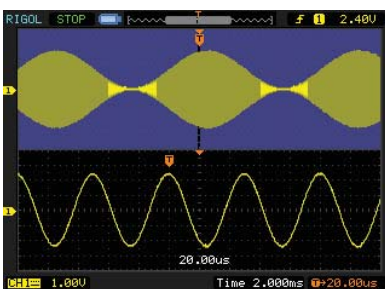

Abundant trigger types

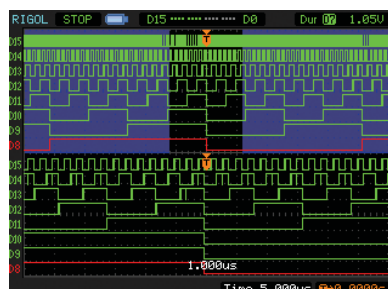

Provide digital logic analysis function (DS1000D)



Key Specifications

Model	DS1204B	DS1104B	DS1074B	DS1102E/D	DS1052E/D
Bandwidth	200MHz	100MHz	70MHz	100MHz	50MHz
Channels	4 + EXT			2 + EXT (DS1000D plus 16 digital channels)	
Real-time Sample Rate	2GSa/s (half channel), 1GSa/s (each channel)			1GSa/s single channel, 500MSa/s dual-channel	
Memory Depth	16kpts (half channel), 8kpts (each channel)			Max. 1Mpts	
Timebase Range	1ns/div-50s/div	2ns/div-50s/div	5ns/div-50s/div	2ns/div-50s/div	5ns/div-50s/div
Input Impedance	1MΩ 18pF			1MΩ 15pF	
Vertical Scale	2mV/div-10V/div				
Rise Time	<1.75ns	<3.5ns	<5ns	<3.5ns	<7ns
Trigger Types	edge, pulse width, slope, video, alternate			edge, pulse width, slope, video, alternate, pattern (DS1000D) and duration (DS1000D)	
Logic analysis specification for DS1xx2D Mix-signal oscilloscope					
Channels	Sample Rate	Memory Depth	Trigger Types	Threshold Level	
16	200MSa/s per channel	512k per channel	pattern and duration	TTL=1.4V, CMOS=2.5V, ECL=-1.3V, USER= -8V ~ +8V	

Ordering Information

	Description	Order Number
Model	DS1102E (100MHz, 1Mpts, 2CH)	DS1102E
	DS1052E (50MHz, 1Mpts, 2CH)	DS1052E
	DS1102D (100MHz, 2+16 CH)	DS1102D
	DS1052D (50MHz, 2+16 CH)	DS1052D
	DS1204B (200MHz, 4CH)	DS1204B
	DS1104B (100MHz, 4CH)	DS1104B
	DS1074B (70MHz, 4CH)	DS1074B
Standard Accessories	1 passive probe (1X:35MHz / 10X:150MHz BW) for each analog channel	PVP2150
	DS1204B standard with (1X:35MHz / 10X:350MHz BW) passive probe	PVP2350
	1 Set LA probe (DS1000D only)	LA Module
	Power Cord	-
	Quick Guide	-

Bus Analysis Guide

Serial bus like I2C, SPI, UART/RS232, USB are widely used in electronic and telecom products as well as other embedded devices. RIGOL mainstream oscilloscope provides common used bus analysis functions. The scope can trigger the at start frame, end frame, specific

address and/or data, as well as error frame. Also, the scope can finish bus decoding functions which can help users to discover errors, debug hardware and accelerate development easily, so as to guarantee quick and high-quality accomplishment of projects.

Series and Options	Decoding Buses	Channel	I2C		SPI		RS232/UART		CAN		LIN		FlexRay	
			Trigger	Decod	Trigger	Decod	Trigger	Decod	Trigger	Decod	Trigger	Decod	Trigger	Decod
DS6000 Series	2	Analog	●		●		●		●				●	
SD-I2C/SPI-DS6000				○		○								
SD-RS232-DS6000							○							
SD-CAN-DS6000									○					
SD-FlexRay-DS6000														○
MSO/DS4000 Series	2	Analog & Digital	●		●		●		●				●	
SD-I2C/SPI-DS4000				○		○								
SD-RS232-DS4000							○							
SD-AUTO-DS4000									○	○	○			
SD-FlexRay-DS4000														○
BND-MSO/DS4000				○		○		○	○	○	○			○
DS4000E Series	2	Analog	●		●		●		●				●	
SD-I2C/SPI-DS4000				○		○								
SD-RS232-DS4000							○							
SD-AUTO-DS4000									○	○	○			
SD-FlexRay-DS4000														○
BND-MSO/DS4000				○		○		○	○	○	○			○
MSO/DS2000A Series	2	Analog & Digital	●		●		●							
SD-DS2000				○		○		○						
CAN-DS2000A									○	○				
BND-MSO/DS2000A				○		○		○	○	○				
DS2000E Series	2	Analog	●		●		●							
SD-DS2000				○		○		○						
CAN-DS2000A									○	○				
BND-MSO/DS2000A				○		○		○	○	○				
MSO/DS1000Z Series	2	Analog & Digital												
AT-DS1000Z			○		○		○							
SA-DS1000Z			○	○	○	○	○	○						

● Standard ○ Option, could be used

Power Measurement and Analysis



Power supply is an important component of electronic devices. The quality of power supply will have direct influences on the electronic devices. During the design and manufacture of power supply, performance testing becomes more and more important.

Ultra Power Analyzer is a power measurement and analysis software. The software along with RIGOL DS6000/MSO4000/DS4000/DS4000E/MSO2000A/DS2000A series digital oscilloscope, high voltage differential probe, current probe, probe deskew fixture, and passive probe, form a complete power measurement system for power supply design and testing. It can analyze switching power supply efficiency and reliability.

- Power quality analysis
- Current harmonics analysis
- Inrush current analysis
- Power device analysis
- Safe operating area analysis
- Modulation analysis
- Output analysis

Power quality analysis



Safe operating area analysis



Power device switching loss analysis



Output ripple analysis



Recommended Configuration

	Description	Order Number
Scope	DS6000, MSO/DS4000, DS4000E, MSO/DS2000A, MSO/DS1000Z Series	
Probes	High Voltage Differential Probe (depend on bandwidth and voltage range in practical application)	RP1000D Series
	Current probe (depend on bandwidth and current range in practical application)	RP1000C Series
PC Software	Ultra Power Analyzer	UPA-DS
Other Accessories	T2R1000 probe adapter (convert TekProbe to RIGOL standard BNC connector)	T2R1000

Current & Active Probes

RP1000D High Voltage Differential Probe



RP1003C/04C Current Probe



RP7150/7180 Differential Probe



RP1001C/02C Current Probe



RP1018H High Voltage Probe



RP7150S/7080S Single ended Probe



Probes & Accessories Guide

Model	Descriptions	DS6000	MSO/DS4000	DS4000E	MSO/DS2000A	DS2000E	MSO/DS1000Z	DS1000E/B	DS1204B	DS1000D
RP7150	1.5GHz Differential/Single ended Probe, 30Vp, CATI	○	○	○						
RP7150S	1.5GHz Single ended Probe, 30Vp, CATI	○	○	○						
RP7080	800MHz Differential/Single ended Probe, 30Vp, CATI	○	○	○						
RP7080S	800MHz Single ended Probe, 30Vp, CATI	○	○	○						
RP6150A	1.5GHz Low Z Probe	●	○	○						
RP5600A	600MHz High Z Probe 10X	●	○	○						
RP3500A	500MHz High Z Probe 10X	○	●	○	○	○	○	○	○	○
PVP2350	1X:35MHz / 10X:350MHz High Z Probe	○	○	●	●	●	○	○	●	○
PVP2150	1X:35MHz / 10X:150MHz High Z Probe	○	○	○	○	○	●	●	○	●
RP1300H	DC-300MHz, 2000V CATI, 1500V CATII (DC+AC)	○	○	○	○	○	○	○	○	○
RP1010H	High Voltage Probe, DC-50MHz, DC:10KV, AC:Pulse≤ 20KVpp,Sine≤ 7KVrms	○	○	○	○	○	○	○	○	○
RP1018H	High Voltage Probe, DC-150MHz, DC+AC:18KVp CATII, AC:12KVrms CATII	○	○	○	○	○	○	○	○	○
RP1025D	High Voltage Differential Probe, DC-25MHz, Vmax ≤ 1400Vpp	○	○	○	○	○	○	○	○	○
RP1050D	High Voltage Differential Probe, DC-50MHz, Vmax ≤ 7000Vpp	○	○	○	○	○	○	○	○	○
RP1100D	High Voltage Differential Probe, DC-100MHz, Vmax ≤ 7000Vpp	○	○	○	○	○	○	○	○	○
RP1001C	Current Probe,DC-300KHz, DC: ±100A, AC: 200App,70Arms	○	○	○	○	○	○	○	○	○
RP1002C	Current Probe,DC-1MHz, DC: ±70A, AC: 140App, 50Arms	○	○	○	○	○	○	○	○	○
RP1003C	Current Probe,DC-50MHz, Max. AC Peak: 50A (Non-continuous), 30Arms. Must order power supply RP1000P	○	○	○	○	○	○	○	○	○
RP1004C	Current Probe,DC-100MHz, Max. AC Peak: 50A (Non-continuous), 30Arms. Must order power supply RP1000P	○	○	○	○	○	○	○	○	○
RP1005C	Current Probe,DC-10MHz, Max. 150 Arms, 300 A peak (Non-continuous), 500 A peak (@pulse width <=30 ms). Must order power supply RP1000P.	○	○	○	○	○	○	○	○	○
RPL2316	16-channel logic analysis probe for MSO4000,MSO2000A series		●		●					
RPL1116	16-channel logic analysis probe for MSO1000Z series						●			
LA Module	DS1000D logic analysis probe: one data cable, one logic probe, 20 test clips,20 test leads.									●
T2R1000	Tekprobe to RIGOL Scope Adapter	○	○	○						
RM-DSxxx	Rack Mount Kit for different series.	○	○	○	○	○	○	○	○	○
USB-GPIB	USB-GPIB USB to GPIB Module	○	○	○	○	○	○	○	○	○
ARM	ARM Desk Mount Instrument Arm	○								
RT50J	50 ohm Adapter(2W, 1GHz)						○	○	○	○
CK-DS6000	Calibration kit for DS6000 & DS4000 series	○	○	○						

● Standard ○ Option, could be used

Spectrum Analyzer



RIGOL's RSA series is the first type of full-function real-time spectrum analyzer in China. Being equipped with the patented technology Ultra Real, it optimizes performance and price. The superb specifications and outstanding performance can be delivered both in the GPSA and RTSA working modes. With a 10.1" capacitive multi-touch screen with high resolution, it supports various touch gestures. You can also operate it with the externally connected keyboard and mouse. It has the built-in Linux system, and the HDMI interface is available for you to make the communication interface more stable and reliable. It can be widely applied to corporate R&D, factory production, education teaching, and other fields. With excellent performance at an unprecedented price point, the RSA series real-time spectrum analyzer allows you to further improve measurement quality at low costs.

DSA800 series, DSA800E series, DSA700 series, and DSA1000 series spectrum analyzers are based on a brand new spectrum analyzer technical platform, and adopt the latest digital IF technology in design to deliver high performance. These spectrum analyzer products cover different frequency ranges, and its frequency can reach up to 7.5 GHz, the Displayed Average Noise Level (DANL) as low as -161 dBm, phase noise below -98dBc/Hz, RBW 10 Hz. These specifications reach the international advanced level of the same product category. To meet the demands of different users, these spectrum analyzers are also equipped with standard and optional accessories, such as preamplifier (PA), tracking generator (TG), advanced measurement kit (AMK), EMI pre-compliance test software, VSWR measurement kit, teaching kit, VSWR bridge, cables, and converters.

	Frequency Band							Max. RTBW	Min. RBW	Phase Noise (at 10KHz offset)	Software			Hardware	
	0.5 GHz	1 GHz	1.5 GHz	3 GHz	3.2 GHz	6.5 GHz	7.5 GHz				AMK	EMI	VSWR	TG	Preamp
RSA5065/-TG						●		40MHz	1Hz	-108dBc/Hz	○	●	●	with TG	○
RSA5032/-TG					●			40MHz	1Hz	-108dBc/Hz	○	●	●	with TG	○
DSA705	●								100Hz	-80dBc/Hz	○	○		without	○
DSA710		●							100Hz	-80dBc/Hz	○	○		without	○
DSA815/-TG			●						100Hz	-80dBc/Hz	○	○	○	with TG	●
DSA832E/-TG					●				10Hz	-90dBc/Hz	○	○	○	with TG	●
DSA832/-TG					●				10Hz	-98dBc/Hz	○	○	○	with TG	●
DSA875/-TG							●		10Hz	-98dBc/Hz	○	○	○	with TG	●

● Standard ○ Option

RSA5000 Series Spectrum Analyzer



The RSA5000 series real-time spectrum analyzer includes four models: RSA5065, RSA5065-TG, RSA5032, and RSA5032-TG. Of which, the model with "-TG" is equipped with the tracking generator. The frequency band of the RSA5000 series real-time spectrum analyzer ranges from 9 kHz to 6.5 GHz, and from 9 kHz to 3.2 GHz, respectively. The RSA5000 series has a standard configuration of GPSA and RTSA modes, capable of delivering excellent performance at low costs. The RSA5000 series is a real-time spectrum analyzer with the patented technology Ultra Real. Both in the GPSA and RTSA working modes, it can deliver excellent performance and best specifications. The general-purpose spectrum analyzer may not fully capture the signal due

10.1" capacitive multi-touch screen; supporting touch gestures



RBW: 1 Hz (min.)

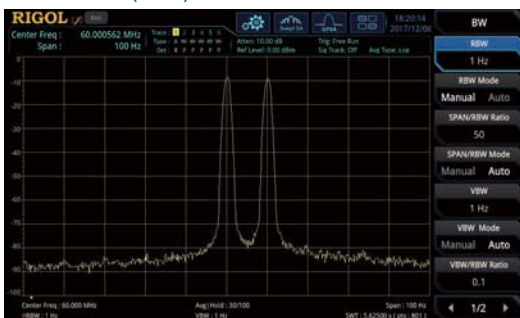

Observe the changes of the time-varying signals in the Spectrum view

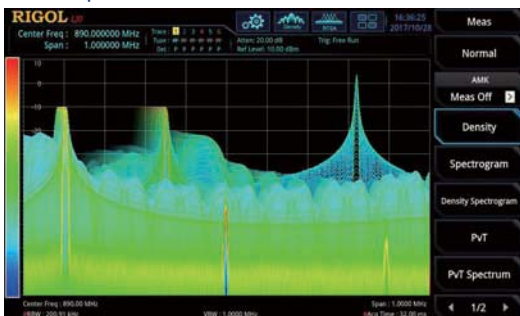

to the deadtime and slow sweep, which may even result in signal loss. Compared with the general-purpose spectrum analyzer, the real-time spectrum analyzer can perfectly address the above issue.

GPSA is a swept working mode, which realizes the function of the general-purpose spectrum analyzer. Compared with DSA800/E and DSA700 series, its key specifications such as phase noise, DANL, RBW, and sweep speed have been greatly enhanced. RTSA is a real-time working mode, which can seamlessly capture the transient signal, and display the measurement results completely in the Density view, Spectrum view, etc. Users can set the FMT trigger mode to accurately capture the signal of interest.

- Frequency stability: 0.5 ppm, option: 0.005 ppm
- Phase noise: <-108 dBc/Hz (typical)
- DANL: -165 dBm (typical)
- RBW: 1 Hz to 10 MHz
- Full-scale accuracy: <0.8 dB
- Sweep rate: 1 ms
- Real-time bandwidth: 25 MHz, option: 40 MHz
- FFT rate: 146,484 FFTs/s
- POI: 7.45 μ s
- SFDR: <-60 dBc (typical)

Excellent swept specifications; phase noise: -108 dBc (min.)

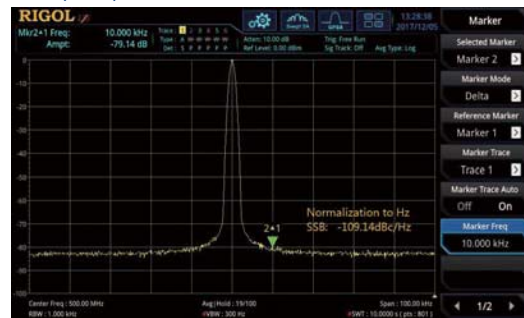

DANL: -165 dBm (min.)



Monitor spectrum signal in the persistence view

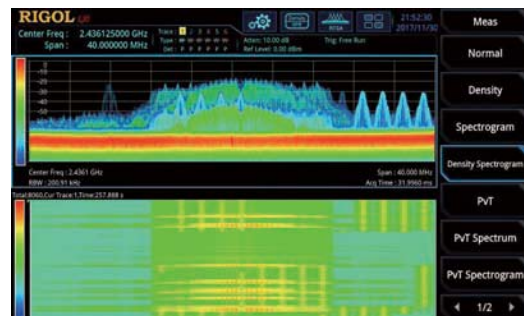

Use FMT to accurately capture signals

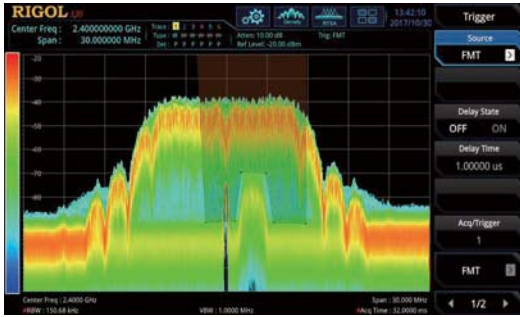

Various advanced measurement functions



Key Specifications

	RSA5032	RSA5032-TG	RSA5065	RSA5065-TG
Frequency Range	9 kHz to 3.2 GHz		9 kHz to 6.5 GHz	
Frequency Stability	0°C to 50°C, with the reference 25°C			
	Standard	<0.5 ppm		
	Option OCXO-C08	<0.005 ppm		
Phase Noise	10 kHz, $f_c = 500$ MHz	<-106 dBc/Hz, <-108 dBc/Hz (typical)		
Resolution Bandwidth (-3 dB)	1 Hz to 10 MHz, in 1-3-10 sequence			
Resolution Bandwidth (-6 dB)	200 Hz, 9 kHz, 120 kHz, 1 MHz			
Displayed Average Noise Level (DANL)	preamp on, attenuation = 0 dB, sample detector, trace averages ≥ 50 , tracking generator off, normalized to 1 Hz, 20°C to 30°C, input impedance = 50 Ω . <-162 dBm, <-165 dBm (typical)			
Level Measurement Uncertainty	0.8 dB (nominal)			
TG Frequency Range	--	100 kHz to 3.2 GHz	--	100 kHz to 6.5 GHz
TG Output Level Range	--	-40 dBm to 0 dBm	--	-40 dBm to 0 dBm
Real-time Analysis Bandwidth	25 MHz, 40 MHz (Option RSA5000-B40)			
Full-scale Accuracy	maximum span; default Kaiser Window			
Min. signal duration for 100% POI at the full-scale accuracy	7.45 μ s			
Window Type	Hanning, Blackman-Harris, Rectangular, Flattop, Kaiser, Gaussian			
Max. Sample Rate	51.2 MSa/s			
FFT Rate	146,484 FFTs/s (nominal)			
SFDR	mixer level = -30 dBm			
	<-60 dBc/Hz (typical)			
Trigger Source	Free Run, External, Power, FMT			

Order Information

	Description	Order No.
Model	Real-time Spectrum Analyzer, 9 kHz to 3.2 GHz	RSA5032
	Real-time Spectrum Analyzer, 9 kHz to 3.2 GHz (with tracking generator, factory installed)	RSA5032-TG
	Real-time Spectrum Analyzer, 9 kHz to 6.5 GHz	RSA5065
	Real-time Spectrum Analyzer, 9 kHz to 6.5 GHz (with tracking generator, factory installed)	RSA5065-TG
Standard Accessories	Quick Guide (hard copy)	-
	Power Cord	-
Option	Preamplifier (PA)	RSA5000-PA
	Highly Stable Clock	OCXO-C08
	Real-time Analysis Bandwidth 40 MHz	RSA5000-B40
	Advanced Measurement Kit	RSA5000-AMK
	Spectrum Analyzer PC Software (only supported in GPSA mode)	Ultra Spectrum
	EMI Pre-compliance Test Software	S1210 EMI Pre-compliance Software

For optional options and accessories of other RF instruments, please refer to "RF Accessories Selection Guide".

DSA800/E Series Spectrum Analyzer



DSA800 and DSA800E series spectrum analyzer are the high performance economic level spectrum analyzers which have compact size and light weight. The digital IF technology guarantees their reliability and performance. The measurement frequency range is up to 7.5GHz.

In order to satisfy different customers' applications, there're lots of standard or optional function and accessories, for example, the pre-amplifier, Advanced Measurement kit, TG models, the VB series bridges and VSWR measurement function, ASK/FSK demodulation, EMI pre-compliance test software and so on.

- Frequency range from 9KHz to 7.5GHz
- Min. RBW 10 Hz
- Min. Displayed Average Noise Level -161 dBm
- Min. Phase Noise < -98 dBc/Hz @ 10 kHz Offset
- EMI Pre-compliance test
- VSWR Measurement
- Signal seamless capture mode (DSA815)
- Powerful DSA PC software

Distinguish the two nearby signals clearly with the 10 Hz RBW

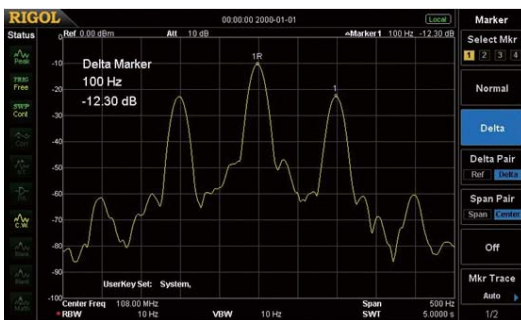

EMI kit (EMI filter & Quasi-peak & Pass/Fail)

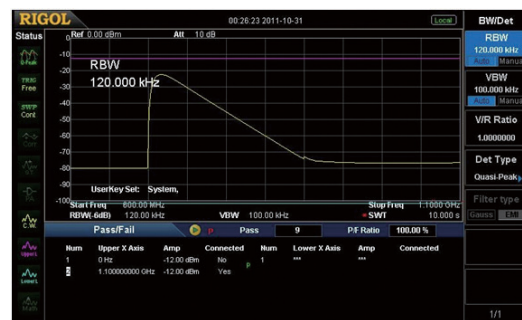

Phase noise < -98 dBc/Hz @10 kHz offset (DSA832/DSA875/DSA832E)

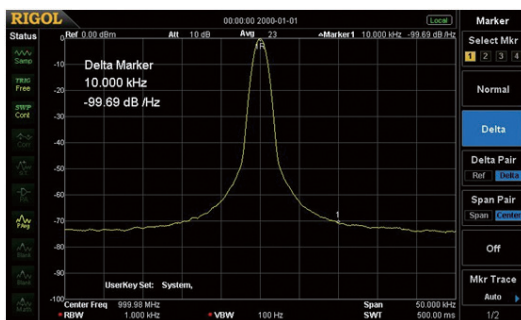

VSWR measurement

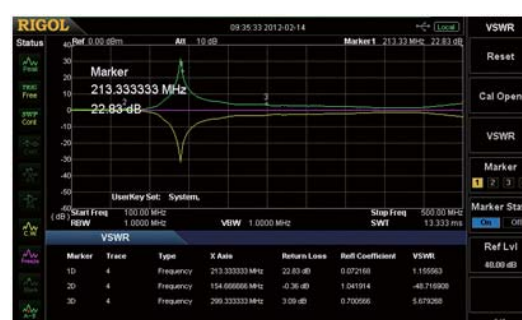

Measure lower level signal with the preamplifier turn on

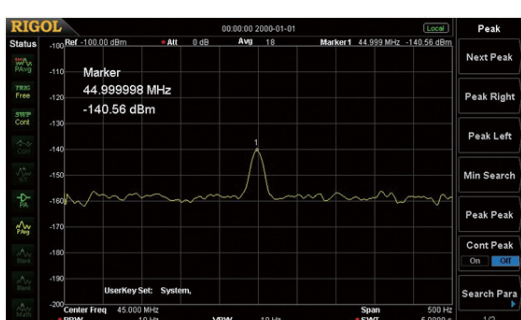

Powerful DSA PC software

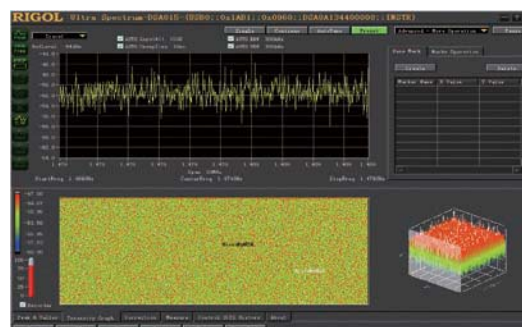

Key Specifications

	DSA815	DSA832	DSA875	DSA832E
Frequency range	9 kHz to 1.5 GHz	9 kHz to 3.2 GHz	9 kHz to 7.5 GHz	9 kHz to 3.2 GHz
Frequency resolution	1 Hz			
Aging rate	<2 ppm/year	<1 ppm/year		<2 ppm/year
SSB Phase Noise(fc=1GHz)	<-80 dBc/Hz@10kHz offset	<-98 dBc/Hz@10kHz offset		<-90 dBc/Hz@10kHz offset offset <-98 dBc/Hz@10kHz offset (typ.)
	<-100 dBc/Hz@100kHz offset (typ.)	<-100 dBc/Hz@100kHz offset (typ.)		<-100 dBc/Hz@100kHz offset (typ.)
Resolution bandwidth (-3 dB)	10 Hz to 1 MHz, in 1-3-10 sequence			
Video bandwidth (-3 dB)	1 Hz to 3 MHz, in 1-3-10 sequence			
Resolution bandwidth (-6 dB)	200 Hz, 9 kHz, 120 kHz (EMI-DSA800 option)			
Displayed Average Noise Level (DANL)	PA on , attenuation = 0 dB, RBW = VBW = 100 Hz, sample detector, trace average ≥ 50, tracking generator off, normalized to 1Hz, 20°C to 30°C , input impedance = 50 Ω			
100 kHz to 1 MHz	<-130 dBm, <-150 dBm (typ.)	<-152 dBm (typ.)	<-152 dBm (typ.)	<-152 dBm (typ.)
1 MHz to 5 MHz	<-150 dBm + 6 × (f/1 GHz) dB, <-155 dBm (typ.)	<-152 dBm, <-155 dBm (typ.)	<-152 dBm, <-155 dBm (typ.)	<-150 dBm, <-155 dBm (typ.)
5 MHz to 1.5 GHz		<-157 dBm,	<-157 dBm,	<-155 dBm,
1.5 GHz to 3.2 GHz		<-161 dBm (typ.)	<-161 dBm (typ.)	<-161 dBm (typ.)
3.2 GHz to 6 GHz			<-153 dBm, <-157 dBm (typ.)	
6 GHz to 7.5 GHz			<-148 dBm, <-152 dBm (typ.)	
Trace detectors	normal, positive-peak, negative-peak, sample, RMS, voltage average, quasi-peak (with EMI-DSA800 option)			
Trace functions	clear write, max hold, min hold, average, view, blank			
Units of level axis	dBm, dBmV, dBμV, nV, μV, mV, V, nW, μW, mW, W			
Level measurement uncertainty	<1.5 dB (nom.)	<0.8 dB (nom.)		<1.0 dB (nom.)
TG Frequency range (-TG model)	100 kHz to 1.5 GHz	100 kHz to 3.2 GHz	100 kHz to 7.5 GHz	100 kHz to 3.2 GHz
TG Output level range (-TG model)	-20 dBm to 0 dBm	-40 dBm to 0 dBm		
TG Output level resolution (-TG model)	1 dB			
SSC Measurement bandwidth	1.5 MHz			
ASK/FSK Demodulation Analysis (PC option)		Support S1220 ASK-FSK Demodulation Analysis		
Interfaces	LAN(LXI), USB, USB-GPIB(Option)			

Ordering Information

	Description	Order Number
Model	spectrum analyzer, 9 kHz to 1.5 GHz	DSA815
	spectrum analyzer, 9 kHz to 3.2 GHz	DSA832
	spectrum analyzer, 9 kHz to 7.5 GHz	DSA875
	spectrum analyzer, 9 kHz to 3.2 GHz	DSA832E
	spectrum analyzer, 9 kHz to 1.5 GHz (with tracking generator, factory installed)	DSA815-TG
	spectrum analyzer, 9 kHz to 3.2 GHz (with tracking generator, factory installed)	DSA832-TG
	spectrum analyzer, 9 kHz to 7.5 GHz (with tracking generator, factory installed)	DSA875-TG
	spectrum analyzer, 9 kHz to 3.2 GHz (with tracking generator, factory installed)	DSA832E-TG
Options	EMI filter & quasi-peak detector	EMI-DSA800
	advanced measurement kit	AMK-DSA800
	VSWR measurement kit	VSWR-DSA800
	DSA PC software	Ultra Spectrum
	signal seamless capture (only for DSA815)	SSC-DSA
	EMI Pre-compliance test software	S1210 EMI Pre-compliance Software
	ASK-FSK Demodulation Analysis (only for DSA832/DSA875/DSA832E)	S1220 ASK-FSK Demodulation Analysis Software

For other optional accessories refers to the "RF Accessories Selection Guide".

DSA700 Series Spectrum Analyzer

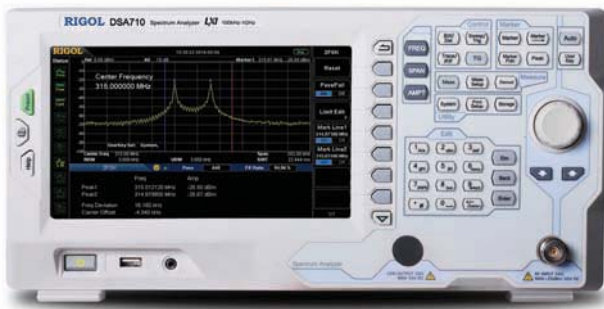

DSA700 series spectrum analyzer are the high performance economic level spectrum analyzers which have compact size and light weight. The digital IF technology guarantees their reliability and performance.

The measurement frequency range is from 100KHz up to 1GHz. In order to satisfy different customers' applications, there're lots of standard or optional function and accessories, for example, the pre-amplifier, Advanced Measurement kit, signal seamless capture mode, EMI pre-compliance test software and so on.

- Frequency range from 100KHz to 1GHz
- Min. RBW 100 Hz
- Min. Displayed Average Noise Level -130 dBm
- Min. Phase Noise < -80 dBc/Hz @ 10 kHz Offset
- EMI Pre-compliance test
- Signal seamless capture mode
- Powerful DSA PC software

Distinguish the two nearby signals clearly with the 100 Hz RBW

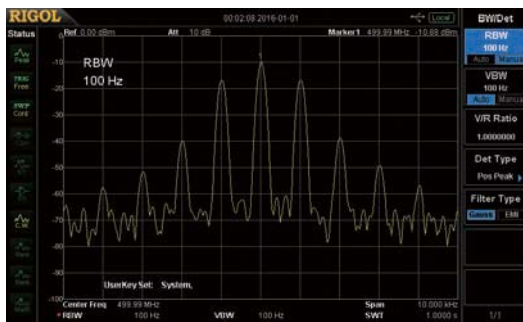

Compare the spectrums with different color trace

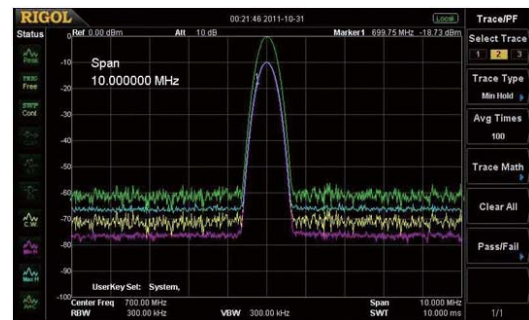

Phase noise < -80 dBc/Hz @10 kHz offset

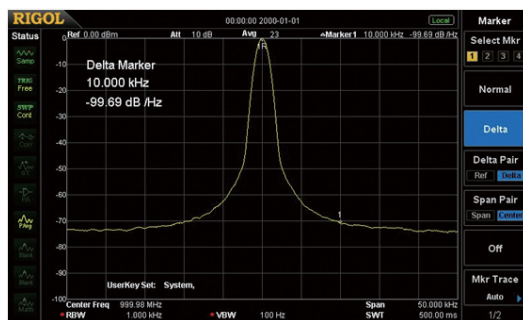

EMI kit (EMI filter & Quasi-peak & Pass/Fail)

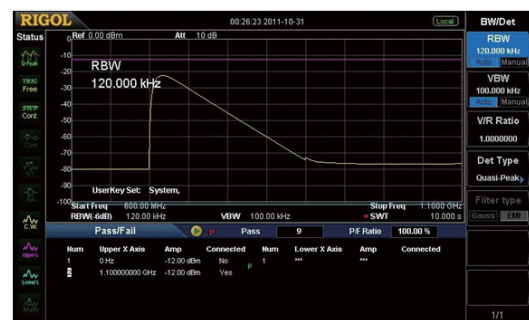

The GUI to control the RF demo kit (Transmitter) directly

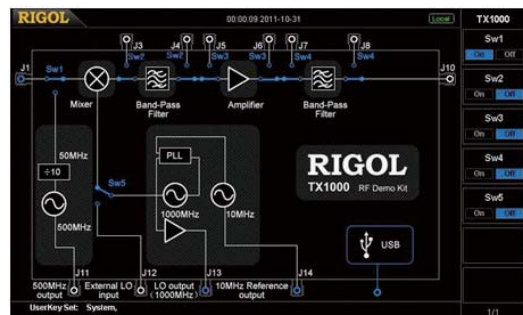

Zero span to demodulate the AM signal

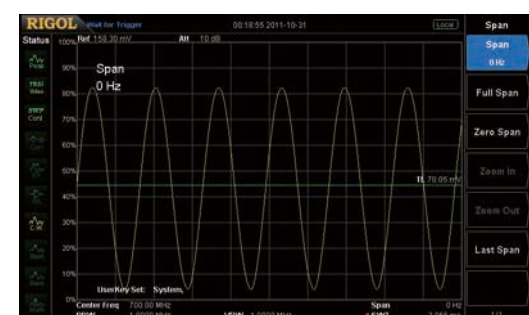

Seamless capture RKE FSK signal

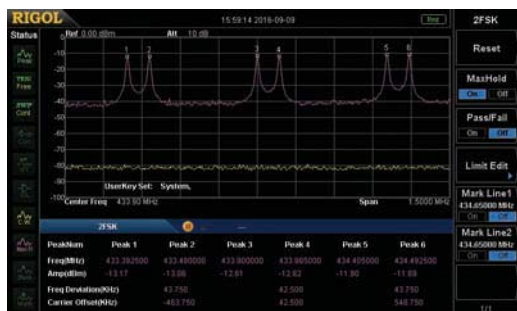

Seamless capture RKE ASK signal

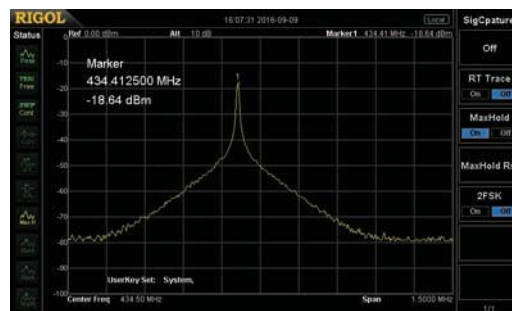

Key Specifications

	DSA705	DSA710
Frequency range	100 kHz to 500 MHz	100 kHz to 1 GHz
Frequency resolution	1 Hz	
Aging rate	<2 ppm/year	
SSB Phase Noise (fc=1GHz)	<-80dBc/Hz@10kHz offset	
Resolution bandwidth (-3dB)	100Hz ~ 1MHz; 1-3-10 step	
Resolution bandwidth (-6dB)	200Hz, 9kHz, 120KHz (EMI-DSA800 option)	
Video bandwidth (-3dB)	1 Hz ~ 3MHz, 1-3-10 step	
Max. DC voltage	50 V	
Max. CW RF power	attenuation = 30 dB, +20 dBm (100 mW)	
Max. damage level	+30 dBm (1 W)	
Displayed Average Noise Level (DANL)	PA ON, RBW=VBW=100Hz, sample detector, trace average ≥ 50	
100 kHz to 1 MHz	<-110 dBm, <-130 dBm (typical)	
1 MHz to 500 MHz	<-120 dBm, <-130 dBm (typical)	
500 MHz to 1 GHz	<-120 dBm, <-130 dBm (typical)	
Trace detectors	normal, positive-peak, negative-peak, sample, RMS, voltage average,quasi-peak (with EMI-DSA800 option)	
Trace functions	clear write, max hold, min hold, average, view, blank	
Units of level axis	dBm, dBmV, dBμV, nV, μV, mV, V, nW, μW, mW, W	
Level measurement uncertainty	<1.5 dB (nom.)	
SSC Measurement bandwidth	1.5 MHz	
Interface	LAN (LXI), USB, USB-GPIB (option)	

Ordering Information

	Description	Order Number
Model	spectrum analyzer, 100 kHz to 500 MHz (with preamplifier)	DSA705
	spectrum analyzer, 100 kHz to 1 GHz (with preamplifier)	DSA710
Standard accessories	quick guide (hard copy)	--
	power cable	--
Options	EMI filter & quasi-peak detector	EMI-DSA800
	advanced measurement kit	AMK-DSA800
	DSA PC software	Ultra Spectrum
	Signal seamless capture	SSC-DSA

For other optional accessories refers to the "RF accessories selection table".

EMI Test System (S1210)

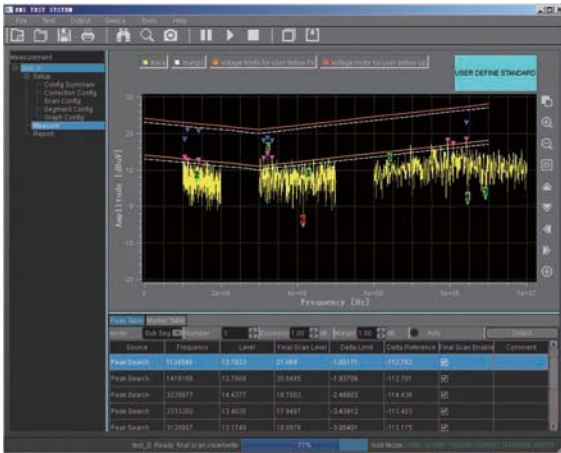

EMI Test System is a PC application software developed by RIGOL for RSA5000, DSA800, DSA800E and DSA700 series with the EMI-DSA800 option to do the EMI Pre-compliance tests.

You can perform conduction and radiation tests using S1210 EMI Pre-compliance Software and RIGOL RSA/DSA series spectrum analyzer. You can measure the interference voltage on the power cable using the linear impedance

stability network (LISN) and perform amplitude correction on the results by loading the correction factor (preamplifier, attenuator, antenna, cable, or correction array) automatically in the radiation test.

This software also provides various functions to facilitate your measurements. You can set various parameters (such as the frequency range, resolution bandwidth, and scan time) via the scan table. After performing a scan, the results can be displayed in log or linear format. You can search for signal peak value and view the results displayed in the peak table. Besides, you can mark and delete the undesired signal, as well as easily recognize signals that do not pass the standard limit line. The software also supports the marker table. In the marker table, you can double click the table to add a marker to mark any frequency point that interests you.

- Provide amplitude correction function.
- Segment scanning and editing for the table to accelerate the measurement speed
- The limit line function can be used to quickly judge the measurement results.
- Provide fast pre-scan and final scan modes.
- Provide peak search function.
- Importing and exporting the peak table
- Frequency axis supports the scale display in linear or log format
- Amplitude axis supports multiple amplitude units
- Provide report generation function

Recommended Configuration

	Description	Order Number
Spectrum Analyzer	RSA5000, DSA800/800E/700 series spectrum analyzer	Refer to RSA/DSA model numbers
	EMI filter & quasi-peak detector of DSA800/800e/700 series spectrum analyzer	EMI-DSA800
EMI Software	EMI Test System Pre-Compliance Test software	S1210
Test Accessories	Near field probe (for near field radiated EMI testing)	NFP-3
	Line Impedance Stabilization Network (LISN) (for conducted EMI testing)	3rd Party
	Antenna (for far field radiated EMI testing)	3rd Party

NFP-3 Near Field Probes

NFP-3 is used with RIGOL RSA/DSA series spectrum analyzer for the EMI tests of electronic products. It can be used to test the magnetic field strength and magnetic field coupling channels on the surface of the electronic components as well as the magnetic field environment near the electronic module so as to quickly locate the interference source. NFP-3 includes four models (NFP-3-P1, NFP-3-P2, NFP-3-P3 and NFP-3-P4).

Measurement Connections

The connection mode of NFP-3 and spectrum analyzer is as shown in the figure below.

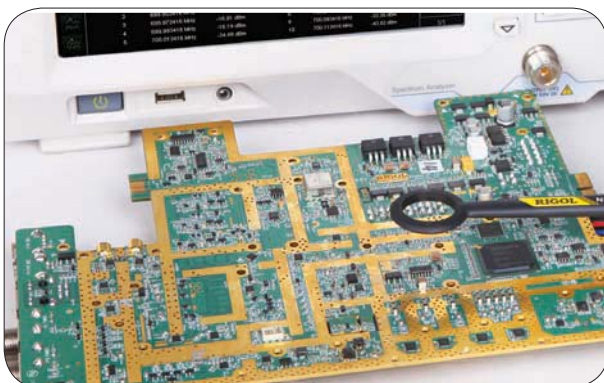

Connect the spectrum analyzer

Connect the SMB (M) terminal of NFP-3 and the BNC (F) terminal of the N-BNC adaptor respectively via the BNC-SMB RF cable; connect the N (M) terminal of the N-BNC adaptor to the RF input terminal of the spectrum analyzer.

Connect the device under test

NFP-3 is used to perform short-distance noncontact measurement on the device under test. Pay attention to the direction of the probe during measuring.

Typical Applications

Locate the EMI radiation interference source. Determine the frequency and relative strength of the spectral component of the interference source.

Specification

Frequency	
Frequency Range	30 MHz to 3 GHz
Terminal Type	
Terminal Type	SMB (M)
Adaptor	N (M)-BNC (F)
RF Cable	BNC (M)-SMB (F), 1000 mm
Terminal and Adaptor Impedance	50 Ω

Common RF Accessories



DSA Utility Kit



RF CATV Kit



30dB High Power Attenuator



RF Adaptor Kit



RF Attenuator Kit



VSWR Bridge



RF Cable

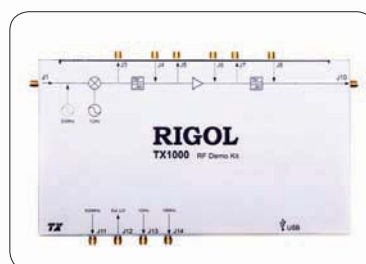

RF Demo Kit (Transmitter) TX1000



RF Demo Kit (Receiver) RX1000

RF Accessories Selection Guide

Options	Descriptions	RSA5065/-TG	RSA5032/-TG	DSA875/-TG	DSA832/-TG	DSA832E/-TG	DSA815/-TG	DSA710	DSA705
AMK-RSA5000	Advanced Measurement Kit.Include:T-Power,ACP(Adjacent Channel Power),ChanPwr(Channel Power),OBW(Occupied Bandwidth),EBW(Emission Bandwidth),C/N Ratio,HarmoDist(Harmonic Distortion),TOI(Third Order Inter modulation)	○	○						
AMK-DSA800	Advanced Measurement Kit.Include:T-Power,ACP(Adjacent Channel Power),ChanPwr(Channel Power),OBW(Occupied Bandwidth),EBW(Emission Bandwidth),C/N Ratio,HarmoDist(Harmonic Distortion),TOI(Third Order Inter modulation)			○	○	○	○	○	○
EMC-RSA5000	EMI filter & quasi-peak detector	●	●						
EMI-DSA800	EMI filter & quasi-peak detector			○	○	○	○	○	○
VSWR-RSA5000	VSWR Measurement Kit.Measurement results include return loss,reflection coefficient and VSWR.(Work with VSWR bridge)	●	●						
VSWR-DSA800	VSWR Measurement Kit.Measurement results include return loss,reflection coefficient and VSWR.(Work with VSWR bridge)			○	○	○	○		
S1210	EMI test PC software for EMI Pre-Compliance testing	○	○	○	○	○	○	○	○
Ultra Spectrum	DSA PC software	○	○	○	○	○	○	○	○
S1220	ASK/FSK Demodulation function			○	○	○			
SSC-DSA	Signal Seamless Capture function	●	●				○	○	○
PA-RSA5000	Preamplifier(for RSA5000 only)	○	○						
PA-DSA800	Preamplifier			●	●	●	●	○	○
B40-RSA5000	Real-time Analysis Bandwidth 40 MHz	○	○						
OCXO-C08	Highly Stable Clock	○	○						
NFP-3	Near Field Probe,30MHz~3GHz,4pcs	○	○	○	○	○	○	○	○
DSA Utility Kit	Include: N-SMA Cable, BNC-BNC Cable, N-BNC Adapter, N-SMA Adapter, 75Ω-50ΩAdapter,Antenna2(900MHz/1.8GHz),Antenna2(2.4GHz)	○	○	○	○	○	○	○	○
RF Adaptor Kit	Include:N(F)-N(F) Adaptor(1pcs),N(M)-N(M) Adaptor(1pcs),N(M)-SMA(F) Adaptor(2pcs),N(M)-BNC(F) Adaptor(2pcs),SMA(F)-SMA(F) Adaptor(1pcs),SMA(M)-SMA(M) Adaptor(1pcs),BNC Ttype Adaptor(1pcs),50Ω SMA Load(1pcs),50Ω Impedance Adaptor(1pcs)	○	○	○	○	○	○	○	○
RF CATV Kit	Include:50Ω to 75Ω Adaptor (2 pcs)	○	○	○	○	○	○	○	○
RF Attenuator Kit	Include:6dB Attenuator (1 pcs),10dB Attenuator (2 pcs)	○	○	○	○	○	○	○	○
ATT03301H	30dB High Power Attenuator,Max.Power 100 W	○	○	○	○	○	○	○	○
CB-NM-NM-75-L-12G	N (M) - N (M) RFCable,upto 12.4 GHz	○	○	○	○	○	○	○	○
CB-NM-SMAM-75-L-12G	N (M) - SMA (M) RF Cable,up to 12.4 GHz	○	○	○	○	○	○	○	○
TX1000	RF Demo Kit (Transmitter)			○	○	○	○	○	○
RX1000	RF Demo Kit (Receiver)			○	○	○	○	○	○
VB1032	VSWR Bridge (1 MHz to 3.2 GHz)	○	○	○	○	○	○		
VB1040	VSWR Bridge (800 MHz to 4 GHz)	○	○	○	○	○	○		
VB1080	VSWR Bridge (2 GHz to 8 GHz)	○	○	○	○	○	○		
RM6041	Rack Mount Kit	○	○						
RM-DSA800	Rack Mount Kit			○	○	○	○	○	○
ARM	Desk Mount Instrument Arm (for DSA1000 series only)								
BAT	11.1V, 147Wh Li-ion Battery Pack								
USB-GPIB	USB to GPIB Interface Converter for Instrument			○	○	○	○	○	○
BAG-G1	Soft Carrying Bag (for DSA800 series only)			○	○	○	○	○	○

● Standard function ○ Options

RF Signal Generator



DSG3000 is a high performance RF signal generator which ranges from 9 kHz to 3 GHz/6 GHz. It is designed for the customers who works in the application filed of Wireless Communication, Radar test, Audio/Video Broadcasting, General Purpose, Education, Consumer Electronics etc. DSG3000 provides variety of analog, digital IQ and pulse modulations with high quality signal and stable specifications. It is a desirable choice for replacing of import products.

DSG800 offers outstanding performance at an affordable price point. There are two models available that cover

output frequencies from 9 kHz to 1.5 GHz or 9 kHz to 3GHz. Maximum output power is +20 dBm (typical). Phase noise reaches -105 dBc/Hz (typical). DSG800 also provides frequency and level sweep functions, AM/FM/ØM analog modulations as well as powerful pulse modulation function. Compared with similar products, DSG800 occupies the very little workbench space and is light in weight. Due to its outstanding portability, it is the perfect choice for various fields such as education laboratories, industrial production lines, as well as research and development labs.

	Frequency Range			Level Range	Accuracy	Clock Stability	Phase Noise	Std. Modulations	Pulse Train Generator	I/Q Modulation
	1.5GHz	3GHz	6GHz							
DSG815	●			-110dBm- +13dBm	≤ 0.5dB (Typ.)	<2ppm <5ppb (B08 Option)	<-100dBc/Hz (<-105dBc/Hz Typ.)	AM/FM/ØM	DSG800-PUM DSG800-PUG (Pulse Modulation + Pulse Train)	-
DSG830		●								
DSG3030		●		-130dBm- +13dBm	≤ 0.5dB (Typ.)	<0.5ppm <5ppb (A08 Option)	<-105dBc/Hz (<-110dBc/Hz Typ.)	AM/FM/ ØM/ Pulse	PUG-DSG3000	IQ-DSG3000
DSG3060			●							

DSG3000 Series RF Signal Generator



DSG3000 is a high performance RF signal generator which ranges from 9 kHz to 3 GHz/6 GHz. It is designed for the customers who works in the application filed of Wireless Communication, Radar test, Audio/Video Broadcasting,

Plenty of Output Functions

9kHz~3/6GHz +25dBm~-140dBm	CW	LF	Sine, Square, Triangle, Ramp, Swp-Sine
Frequency sweep, Amplitude sweep, Frequency and amplitude sweep	Sweep	PMC	Power meter controller, Test system automatic calibration

Excellent Phase Noise Specification

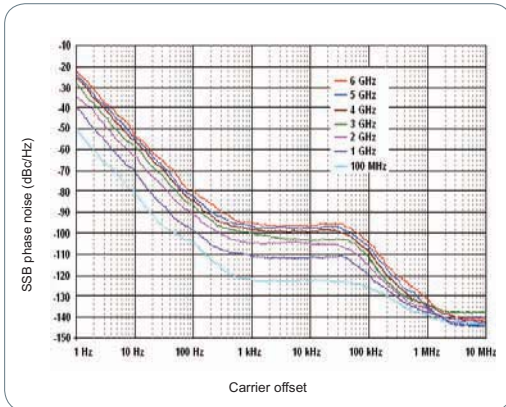

Excellent Amplitude Repeatability (6GHz, 0dBm, ALC ON, 25°C)

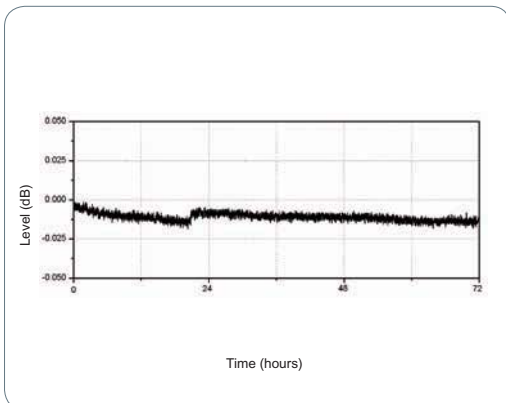

General Purpose, Education, Consumer Electronics etc. DSG3000 provides variety of analog, digital IQ and pulse modulations with high quality signal and stable specifications. It is a desirable choice for replacing of import products.

- Plenty of output functions
- Support multiple types of modulations
- Output amplitude level ranges from -130dBm to +13dBm
- Excellent phase noise specification
- Support internal and external I/Q modulation
- Support pulse modulation with 80dB on/off ratio

Multiple types of Modulations

Internal modulation, External modulation	AM	FM ΦM	Internal modulation, External modulation
Internal modulation, External modulation, Pulse train generator, Pulse generator	Pulse	I/Q	Internal modulation, External modulation, I/Q baseband generator, Baseband output

Pulse Modulation with 80dB on-off ratio

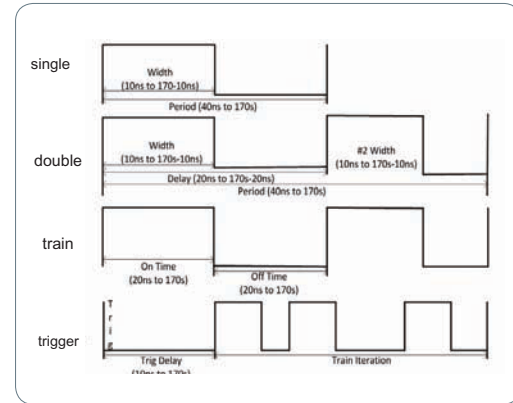

Measured IQ modulation Bandwidth

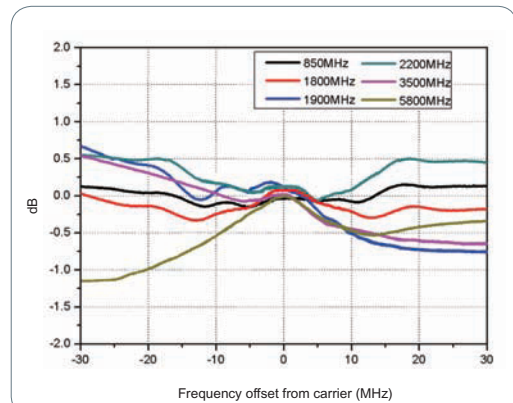

Key Specifications

Model		DSG3030	DSG3060
Frequency range		9kHz-3GHz	9kHz-6GHz
Amplitude output level		-130dBm - +13dBm	
Amplitude setting Level		-140dBm - +25dBm	
Level uncertainty		< 0.5dB typ.	
Clock stability		< 0.5ppm, <5ppb(With option OCXO-A08)	
Spectral purity	SSB phase noise	Typ. <-110dBc/Hz@1GHz,20KHz offset	
	Harmonic	<-30dBc; non-harmonic: typ. <-64dBc	
Sweep	Sweep type	Linear sweep, Step/List sweep, Single/Continue sweep	
	Sweep points	2 ~65535 (Step sweep); 1-6001 (List sweep)	
Modulation type		AM, FM, PM, Pulse mod, I/Q mod	
AM	modulation depth	0%-100%	
	Uncertainty	< setting value x 4% + 1%	
	Modulation frequency response	<3dB(10Hz ~ 50kHz m<80%)	
FM	Max. deviation	N x 1MHz	
	Uncertainty	< setting value x 2% + 20Hz	
	Modulation frequency response	<3dB(10Hz ~ 100kHz)	
PM	Max. deviation	3rad (f ≤ 23.4375MHz), N x 5rad (f > 23.4375MHz)	
	Uncertainty	< setting value x 1% + 0.1rad	
	Modulation frequency response	<3dB(10Hz ~ 100kHz)	
Pulse modulation	On/off ratio	>80dB(25MHz ≤ f <3GHz), >70dB(3GHz ≤ f ≤ 6GHz)	
	Rise/fall time	10ns typ.	
	Pulse mode	Single pulse, dual pulse, pulse train (option PUG-DSG3000)	
I/Q modulation	Bandwidth	External modulation: baseband (I or Q): up to 120MHz; RF(I+Q): up to 240MHz	
		External modulation: baseband (I or Q): up to 30MHz; RF(I+Q): up to 60MHz	
	EVM	≤ 0.7%rms(typ., 50MHz ≤ f ≤ 3GHz, output power ≤ 4dBm)	
		≤ 1.2%rms(typ., 3GHz < f ≤ 6GHz, output power ≤ 4dBm)	
General	Interfaces	Std.: USB, LAN, GPIB	
		10MHz Ref In/Out, Trigger In	
		I/Q In/Out(install IQ modulation option), LF Out	
		Ext Mod, Pulse In/Out	
		Signal Valid, Sweep Out	

Ordering Information

	Description	Order Number
Models	DSG3030 RF Signal Generator, 9kHz-3GHz	DSG3030
	DSG3060 RF Signal Generator, 9kHz-6GHz	DSG3060
Standard Accessories	Power Cable, Quick Guide (Hard Copy)	-
	DSG IQ function PC software	Ultra IQ Station
Options	Pulse Train Generator	PUG-DSG3000
	High Stable OCXO Reference Clock	OCXO-A08
	I/Q Modulation, Baseband Output	IQ-DSG3000
	Power Meter Controller	PMC-DSG3000
	Rack Mount Kit	RM-DSG3000

DSG800 Series RF Signal Generator



DSG800 establishes a new standard of economical RF signal generator by the unprecedented cost-effective advantage. Combining with DSA800 economical spectrum analyzer, the product pair provides a screaming solution for RF test and measurement application.

DSG800 offers outstanding performance comparing with the same-level economical RF signal generator. It covers the frequency range from 9 kHz to 1.5 GHz or 3 GHz. Maximum output power is +20 dBm (typical). Phase noise reaches -105 dBc/Hz (typical).

DSG800 provides the frequency and level sweep functions, AM/FM/ØM analog modulations as well as powerful pulse modulation function. Thus DSG800 can be used as an excitation source to output all kinds of high quality signals (including RF, LF, sweep, pulse and a variety of analog modulated signals), and can be used as a reference source.

- Up to -105 dBc/Hz (typical) phase noise
- Up to +20 dBm (typical) maximum output power
- Special digital ALC circuit ensuring its stability and reliability
- Flexible frequency and amplitude sweep functions
- Complete AM/FM/ØM analog modulation functions
- Powerful pulse modulation function
- Prominent portability; Simple and easy to operate

Measured SSB phase noise

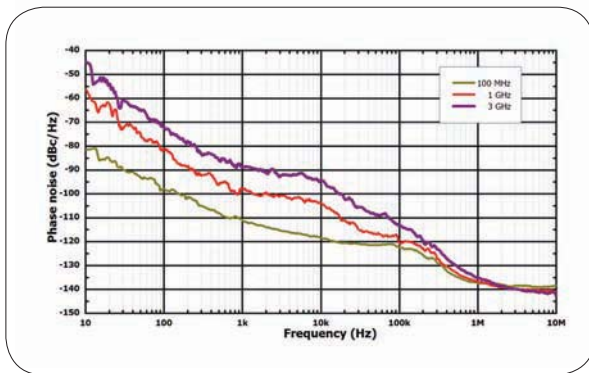

Measured level repeatability @ 1 GHz, 0 dBm

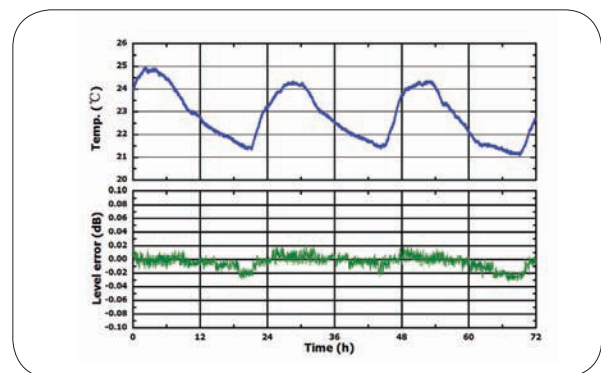

Measured maximum level vs. frequency

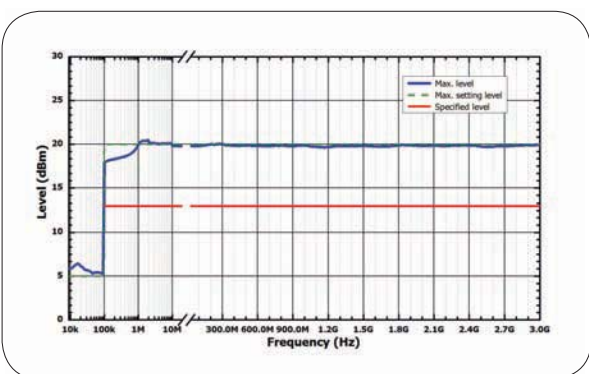

Powerful pulse modulation and pulse train generator

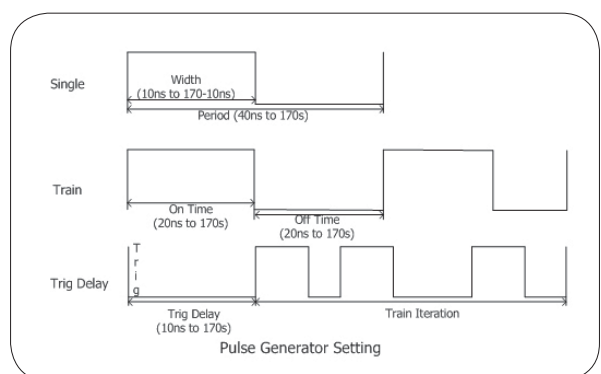

Simultaneous Modulation

	AM	FM	ØM	Pulse mod. (opt.)
AM	—	○	○	△
FM	○	—	×	○
ØM	○	×	—	○
Pulse mod. (opt.)	△	○	○	—

Note: ○: Compatible; ×: Not compatible; △: Compatible, but the AM performance will decrease when pulse modulation is turned on.

Key Specifications

Models		DSG815	DSG830
Frequency range		9kHz-1.5GHz	9kHz-3GHz
Amplitude Output Level		-110dBm - +13dBm	
Amplitude Setting Level		-110dBm - +20dBm	
Level uncertainty		<0.9dB (< 0.5dB typ.)	
Clock stability		< 2ppm, <5ppb(With option OCXO-B08)	
Spectral Purity	SSB phase noise	100KHz ≤ f ≤ 1.5GHz, <-100dBc/Hz (<-105dBc/Hz typ.) 1.5GHz ≤ f ≤ 3GHz, <-94dBc/Hz (<-99dBc/Hz typ.) CW mode, carrier offset =20KHz	
	Harmonic	<-30dBc CW mode 1MHz ≤ f ≤ 3GHz, Level ≤ +13dBm	
	Non-harmonic	100KHz ≤ f ≤ 1.5GHz, <-60dBc (<-70dBc typ.); 1.5GHz ≤ f ≤ 3GHz, <-54dBc/Hz (<-64dBc/Hz typ.)	
Sweep	Sweep type	Linear sweep, Step/List sweep, Single/Continue sweep	
	Sweep points	2 ~65535(Step sweep); 1-6001 (List sweep)	
Modulation type		AM, FM, ØM, Pulse mod	
AM	modulation depth	0%-100%	
	Uncertainty	< setting value x 4% + 1%	
	Modulation frequency response	<3dB(10Hz ~ 100kHz m<80%)	
FM	Max. deviation	N x 1MHz	
	Uncertainty	< setting value x 2% + 20Hz	
	Modulation frequency response	<3dB(10Hz – 100KHz)	
PM	Max. deviation	N x 5rad	
	Uncertainty	< setting value x 1% + 0.1rad	
	Modulation frequency response	<3dB(10Hz – 100kHz)	
Pulse modulation	On/off ratio	>70dB(100kHz ≤ f <3GHz)	
	Rise/fall time	<50ns, 10ns (typ.)	
	Pulse mode	Single pulse, pulse train (option DSG800-PUG)	
General	Interfaces	Std.: USB, LAN	
		Front Panel: RF output, Internal modulation generator (LF) output	
		Rear Panel: External trigger input, Signal valid output, Pulse input or output	
		External modulating signal input, 10MHz input/output	

Ordering Information

	Description	Order Number
Models	DSG830 RF Signal Generator, 9kHz-3GHz	DSG830
	DSG815 RF Signal Generator, 9kHz-1.5GHz	DSG815
Standard Accessories	Power Cable, Quick Guide (Hard Copy)	-
Options	Pulse Modulation, Pulse Generator	DSG800-PUM
	Pulse Train Generator (DSG800-PUM Included)	DSG800-PUG
	High Stable Reference Clock	OCXO-B08
	Rack Mount Kit (For one Instrument)	RM-1-DG1000Z
	Rack Mount Kit (For two Instrument)	RM-2-DG1000Z

Function/Arbitrary Waveform Generator



RIGOL's Function / Arbitrary Waveform generator adopts the latest Direct Digital Frequency Synthesis technology (DDS) to generate accurate and stable regular waveforms (such as sine waves and square waves) as well as the Analog or Digital modulated signals. What's more, the generator also provides arbitrary waveform function which allows engineers to generate any desired waveforms either using the UltraWave arbitrary waveform editing software or using the oscilloscope to capture the actual signal and then downloading it to the generator. The digital sampling technology and the Direct Digital Frequency

Synthesis technology enable engineers to generate any desired waveform for circuit verification design.

RIGOL has introduced a complete range of Function / Arbitrary Waveform generators in the past years includes DG1000, DG1000Z, DG2000, DG3000, DG4000 and DG5000 series with up to 350MHz frequency, 1 GSa/s sample rate, 14 bits vertical resolution, 128M points arbitrary waveform memory. The rich features let RIGOL's generators to be the excellent circuit debug tools for engineers.

	Max. Output Frequency (MHz)										Channels	Max. Sample rate	Max. Arb Memory Depth	Modulation Types
	350	250	200	160	100	70	60	30	25	20				
DG5000	●	●			●	●					1/2	1Gsa/s	128M	AM,FM,PM,ASK,FSK,PSK, PWM,IQ
DG4000			●	●	●		●				2	500Msa/s	16K	AM,FM,PM,ASK,FSK,PSK, BPSK,QPSK,3FSK,4FSK,OSK, PWM
DG1000Z							●	●	●		2	200Msa/s	8M/2M(DG1022Z) (16M Opt.)	AM,FM,PM,ASK,FSK, PSK,PWM
DG1000									●	●	2	100Msa/s	4K	AM,FM,PM,FSK

DG5000 Series Function/Arbitrary Waveform Generator



DG5000 is a multifunctional generator that combines many functions in one, including Function Generator, Arbitrary Waveform Generator, IQ Baseband Source/IQ IF Source, Frequency Hopping Source (optional) and Pattern Generator (optional). DG5000 can provide stable, precise, pure and low distortion signal by adopting the Direct Digital Synthesizer (DDS) technology. It provides single and dual-

channel models. The dual-channel model, with two channels having complete equivalent functions and precisely adjustable phase deviation between the two channels, is a real dual-channel signal generator.

- Arb function with 1 GSa/s sample rate, 14 bits vertical resolution
- Support internal and external IQ modulation
- Whole range of Analog/Digital modulation functions (standard)
- Various Sweep Types (standard)
- Intuitive Constellation setup and display
- Support Frequency Hopping function (option)
- Complete connectivity, support Parallel Bus output (Option)

Arb function with 1 GSa/s sample rate, 14 bits vertical resolution

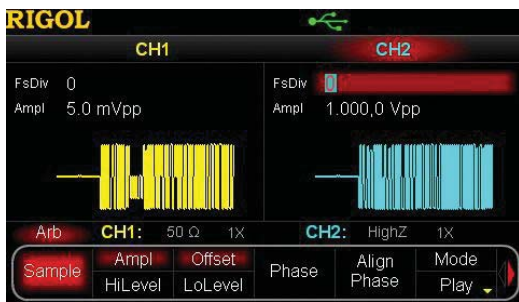

Intuitive Constellation setup and display

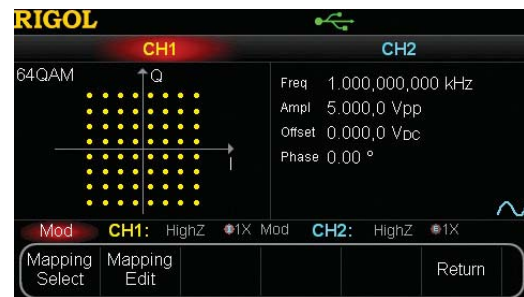

Various Sweep Types (standard)

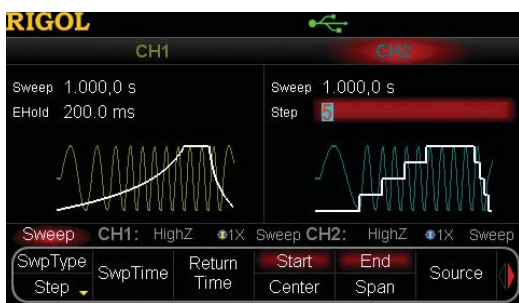

Support Frequency Hopping function (option)

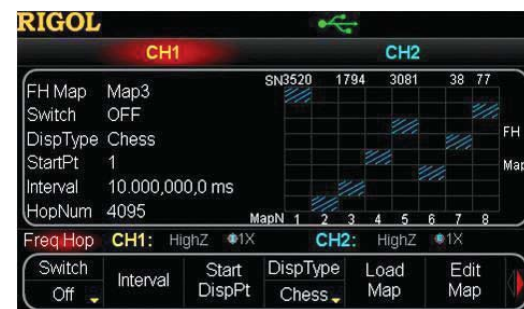

Support internal and external IQ modulation

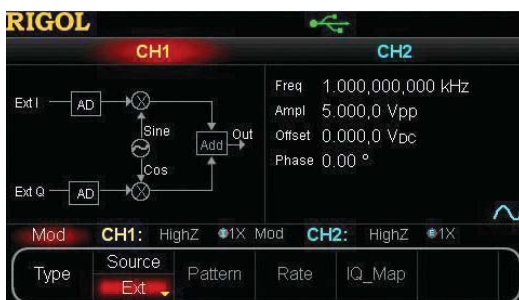

Complete connectivity, support Parallel Bus output (Option)



Key Specifications

Model	DG5351/2	DG5251/2	DG5101/2	DG5071/2
Channel	1/2	1/2	1/2	1/2
Maximum Frequency	350MHz	250MHz	100MHz	70MHz
Sample Rate	1GSa/s			
Waveforms	Standard Waveforms: Sine, Square, Ramp, Pulse, Noise Arbitrary Waveforms: Sinc, Exponential Rise, Exponential Fall, ECG, Gauss, HaverSine, Lorentz, Dual-Tone, DC, User defined			
Frequency Characteristics				
Sine	1uHz-350MHz	1uHz-250MHz	1uHz-100MHz	1uHz-70MHz
Square	1uHz-120MHz	1uHz-120MHz	1uHz-100MHz	1uHz-70MHz
Ramp	1uHz-5MHz	1uHz-5MHz	1uHz-3MHz	1uHz-3MHz
Pulse	1uHz-50MHz			
Noise	250MHz			
Arb	1uHz-50MHz			
Waveform Length	128M (std.)			
Sine Wave Spectrum Purity	Total Harmonic Distortion: <0.5%(10Hz-20KHz,0dBm); Phase Noise: <-110dBc@10MHz (0dBm,10KHz offset)			
Square Rise/Fall Time	<2.5ns	<2.5ns	<3ns	<4ns
Jitter (rms)	≤ 30MHz: 10ppm+500ps, >30MHz: 500ps			
Amplitude (into 50 Ω)	≤ 100MHz: 5mVpp-10Vpp; ≤ 300MHz:5mVpp-5Vpp; ≤ 350MHz:5mV-2Vpp			
IQ Modulation	4QAM,8QAm,16QAM,32QAM,64QAM,BPSK,QPSK,OQPSK,8PSK,16PSK,user; Code Rate: 1bps to 1Mbps; Carrier Waveform: Sine (max.200MHz)			
FH Characteristic	FH Bandwidth 1.5MHz-250MHz; FH Rate: 1 Hop/s to 12.5M Hop/s; Frequency Point Numbers:4096			
Burst Characteristics	Carrier Frequency 1uHz-120MHz, Burst Count: 1 to 1 000 000 or Infinite			

Ordering Information

	Description	Order Number
Model	DG5352 (350 MHz, dual-channel, 128Mpts)	DG5352
	DG5351 (350 MHz, single-channel, 128Mpts)	DG5351
	DG5252 (250 MHz, dual-channel, 128Mpts)	DG5252
	DG5251 (250 MHz, single-channel, 128Mpts)	DG5251
	DG5102 (100 MHz, dual-channel, 128Mpts)	DG5102
	DG5101 (100 MHz, single-channel, 128Mpts)	DG5101
	DG5072 (70MHz, dual-channel, 128Mpts)	DG5072
	DG5071 (70MHz, single-channel, 128Mpts)	DG5071
Standard Accessories	USB Cable	CB-USBA-USBB-FF-150
	BNC Cable (1 meter)	CB-BNC-BNC-MM-100
	SMB(F) to BNC(M) Cable (1 meter)	CB-SMB-BNC-FM-100
	Power Cord	-
	Quick Guide (Hard Copy)	-
Options	Frequency Hopping Module	FH-DG5000
	Logic Signal Output Module	DG-POD-A
	Power Amplifier	PA1011
	40 dB Attenuator	RA5040K
	Rack Mount Kit	RM-DG5000

DG4000 Series Function/Arbitrary Waveform Generator



DG4000 series is a multifunctional generator that integrates many functions into one, including Function Generator, Arbitrary Waveform Generator, Pulse Generator,

Harmonic Generator, Analog/Digital Modulator and Counter. DG4000 can provide stable, precise, pure and low distortion signal by adopting the Direct Digital Synthesizer (DDS) technology. All the models have two channels with complete equivalent functions and precisely phase adjustable, they are the real dual-channel signal generator.

- 7 inch color LCD
- Arbitrary waveform function and built-in 150 waveform
- Abundant analog and digital modulation function
- Various Sweep modes
- Noise and Burst modes
- Up to 16 orders customized Harmonic generation function

Standard 2 identical channels with frequency and phase coupling

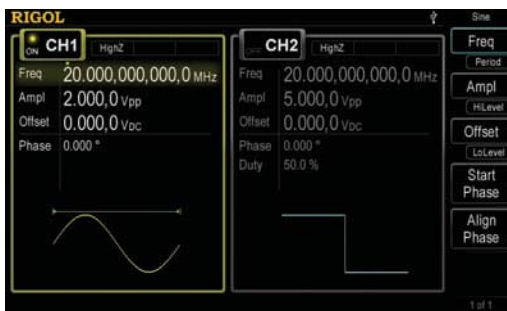

Various Sweep modes

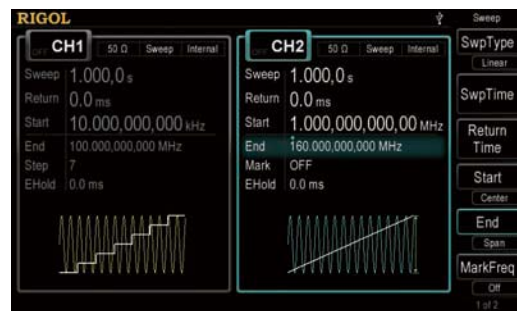

Arbitrary waveform function and built-in 150 waveform

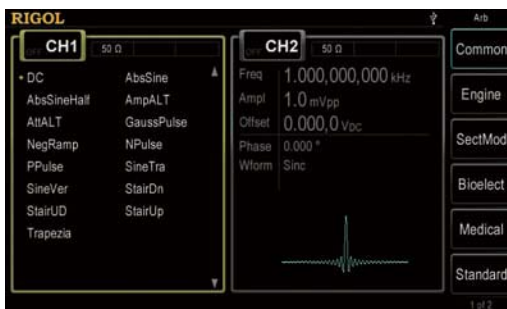

Noise and Burst modes

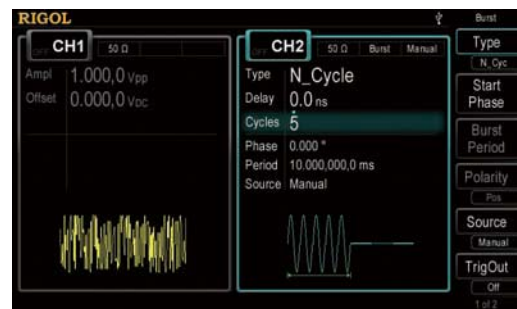

Abundant analog and digital modulation function

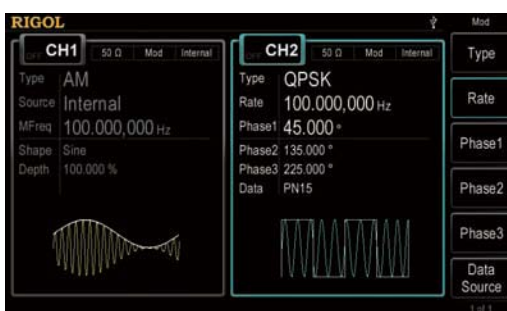

Standard 7digits/s counter with statistic analysis

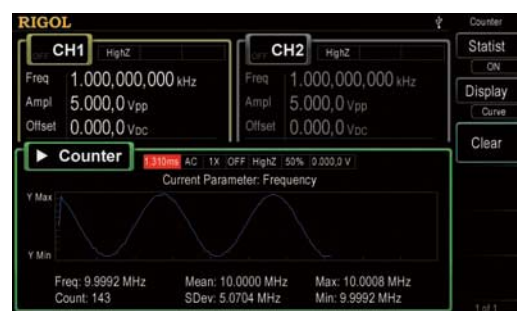

Key Specifications

Model	DG4202	DG4162	DG4102	DG4062
Channel	2			
Maximum Frequency	200MHz	160MHz	100MHz	60MHz
Sample Rate	500Msa/s			
Waveforms	Standard Waveforms: Sine, Square, Ramp, Pulse, Noise, Harmonics (up to 16 orders) Arbitrary Waveforms: Sinc, Exponential Rise, Exponential Fall, ECG, Gauss, HaverSine, Lorentz, Dual-Tone, DC, etc. up to 150 waveforms			
Waveform Length	16K			
Vertical Resolution	14bits			
Sine	1uHz-200MHz	1uHz-160MHz	1uHz-100MHz	1uHz-60MHz
Square	1uHz-60MHz	1uHz-50MHz	1uHz-40MHz	1uHz-25MHz
Ramp	1uHz-5MHz	1uHz-4MHz	1uHz-3MHz	1uHz-1MHz
Pulse/arb	1uHz-50MHz	1uHz-40MHz	1uHz-25MHz	1uHz-15MHz
Noise (-3dB)	120MHz	120MHz	80MHz	60MHz
Sine Wave Spectrum Purity	Total Harmonic Distortion : <0.1%(10Hz-20KHz,0dBm); Phase Noise : ≤ -115dBc@10MHz (0dBm,10KHz offset)			
Square Rise/Fall Time	<8ns	<8ns	<10ns	<12ns
Jitter (rms)	≤ 5MHz: 2ppm+500ps, >5MHz : 500ps			
Amplitude (into 50 Ω)	≤ 20MHz: 1mVpp-10Vpp; ≤ 60MHz:1mVpp-5Vpp; ≤ 120MHz:1mV-2.5Vpp; ≤ 200MHz:1mV-1Vpp			
Modulation Type	AM, FM, PM, ASK, FSK, PSK, BPSK, QPSK, 3FSK, 4FSK, OSK, PWM			
Work Mode	Continue, Burst, Sweep, Modulation			
Burst Characteristics	Carrier Frequency 2mHz-100MHz, Burst Count: 1 to 1 000 000 or Infinite; trigger source: internal, external, manual			

Ordering Information

	Description	Order Number
Model	DG4202 (200 MHz, dual-channel)	DG4202
	DG4162 (160 MHz, dual-channel)	DG4162
	DG4102 (100 MHz, dual-channel)	DG4102
	DG4062 (60 MHz, dual-channel)	DG4062
Standard Accessories	USB Cable	CB-USBA-USBB-FF-150
	BNC Cable (1 meter)	CB-BNC-BNC-MM-100
	Power Cord	-
	Quick Guide (Hard Copy)	-
Optional Accessories	DG4 PC Software(Advanced functions)	Ultra Station-adv
	40 dB Attenuator	RA5040K
	Rack Mount Kit	RM-DG4000
	USB-GPIB Module	USB-GPIB

DG1000Z Series Function/Arbitrary Waveform Generator



DG1000Z series function/arbitrary waveform generator is a multi-functional generator that combines many functions in one, including Function Generator, Arbitrary Waveform Generator, Noise Generator, Pulse Generator, Harmonics

Generator, Analog/Digital Modulator and Counter.

The maximum output frequency (Sine) of DG1000Z is 25MHz/30MHz/60MHz. It provides 2 full functional channels with precisely phase adjustable. The standard interfaces are USB and LAN.

- Innovative SiFi technology
- Up to 160 built-in waveforms
- Multiple analog and digital modulations
- Standard harmonic generator
- Waveform summing function
- Standard 7 digits/s full function frequency counter

Standard 2 full functional channels

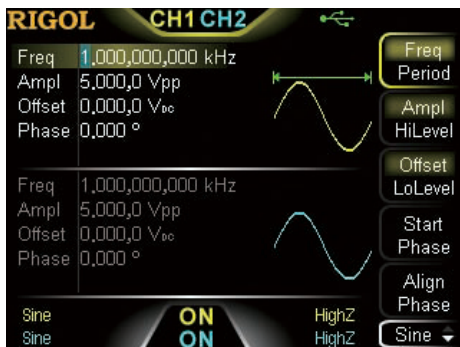

Arbitrary waveform function with innovative SiFi technology

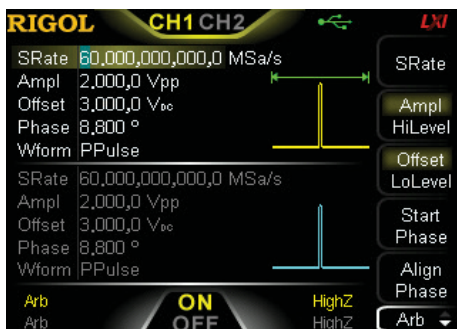

Up to 160 built-in waveforms



Multiple analog and digital modulations

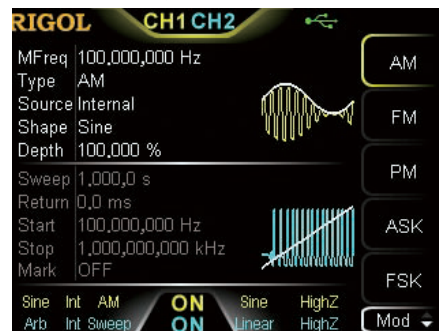

Standard harmonic generator



Burst function

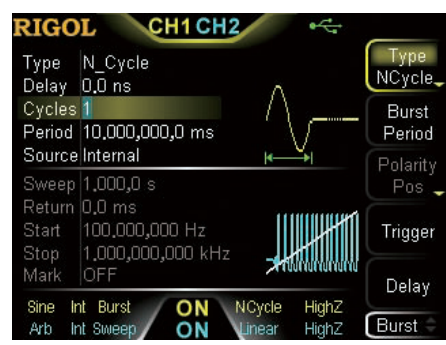

Key Specifications

Model	DG1062Z	DG1032Z	DG1022Z
Channel	2		
Maximum Frequency	60MHz	30MHz	25MHz
Sample Rate	200Msa/s		
Waveforms	Waveforms Standard Waveforms: Sine, Square, Ramp, Pulse, Noise, Harmonics (up to 8 orders) Arbitrary Waveforms: Sinc, Exponential Rise, Exponential Fall, ECG, Gauss, HaverSine, Lorentz, Dual-Tone, DC, etc. up to 160 waveforms		
Waveform Length	8pts to 8Mpts, optional 16Mpts		8pts to 2Mpts, optional 16Mpts
Vertical Resolution	14bits		
Sine	1uHz–60MHz	1uHz–30MHz	1uHz–25MHz
Square	1uHz–25MHz	1uHz–25MHz	1uHz–25MHz
Ramp	1uHz–1MHz	1uHz–500KHz	1uHz–500KHz
Pulse	1uHz–25MHz	1uHz–15MHz	1uHz–15MHz
Arb/Harmonics	1uHz–20MHz	1uHz–10MHz	1uHz–10MHz
Noise (-3dB)	60MHz BW	30MHz BW	25MHz BW
Sine Wave Spectrum Purity	Total Harmonic Distortion : <0.075%(10Hz-20KHz,0dBm); Phase Noise : <-125dBc@10MHz (0dBm,10KHz offset)		
Square Rise/Fall Time	Typ. (1Vpp) <10ns		
Jitter (rms)	Typ. (1Vpp) ≤ 5MHz: 2ppm+200ps, >5MHz : 200ps		
Amplitude (into 50 Ω)	≤10MHz: 1 mVpp-10Vpp; ≤30MHz:1 mVpp-5Vpp; ≤60MHz:1 mV-2.5Vpp		
Modulation Type	AM, FM, PM, ASK, FSK, PSK, PWM		
Work Mode	Continue, Burst, Sweep, Modulation		
Burst Characteristics	Carrier Frequency 2mHz-25MHz/30MHz/60MHz, Burst Count: 1 to 1 000 000 or Infinite; Trigger source: internal, external, manual		
Standard Interfaces	USB (Device), USB (Host), LAN (LXI-C), USB-GPIB (Opt.)		

Ordering Information

	Description	Order Number
Model	DG1022Z (25MHz, Dual-channel)	DG1022Z
	DG1032Z (30MHz, Dual-channel)	DG1032Z
	DG1062Z (60MHz, Dual-channel)	DG1062Z
Standard Accessories	USB Cable	CB-USBA-USBB-FF-150
	BNC Cable (1 meter)	CB-BNC-BNC-MM-100
	Power Cord	-
	Quick Guide	-
Optional Accessories	16Mpts Memory for Arb	ARB16M-DG1000Z
	40dB Attenuator	RA5040K
	10W Power Amplifier	PA1011
	Rack Mount Kit (for single instrument)	RM-1-DG1000Z
	Rack Mount Kit (for dual instruments)	RM-2-DG1000Z
	USB-GPIB module	USB-GPIB

DG1000 Series Function/Arbitrary Waveform Generator



DG1000 Series function/arbitrary waveform generators use Direct Digital Synthesis (DDS) technology and can generate accurate, stable, clean, low distortion signals. It provides dual channel with 5 standard waveforms and built-in 48 arbitrary waveforms.

- 1μHz frequency resolution
- 2mV minimum range (50 Ohm)
- Dual channel output synchronously
- 48 built-in arbitrary waveforms
- 200 MHz built-in frequency counter

Key Specifications

Model	DG1022A				DG1022	
Channel	2					
Maximum Frequency	25MHz			20MHz		
Sample Rate	100Msa/s					
Waveforms	Sine, Square, Ramp / Triangular, Pulse, Noise, Arb (built-in 48 waveforms)					
Waveform Length	CH1: 4Kpts; CH2: 1Kpts					
Vertical Resolution	CH1: 14bits; CH2: 10bits					
Waveform Characteristics	Sine	Square	Pulse	Ramp	Noise	Arb
DG1022A	1uHz-25MHz	1uHz-5MHz	500uHz-5MHz	1uHz-500KHz	5MHz(-3dB)	1uHz-5MHz
DG1022	1uHz-20MHz		500uHz-3MHz	1uHz-150kHz		
Sine Wave Spectrum Purity	Total Harmonic Distortion: <0.2%(10Hz-20KHz,0dBm); Phase Noise: <-108dBc@10MHz (0dBm,10KHz offset)					
Square Rise/Fall Time	<20ns					
Amplitude (into 50 Ω)	CH1: ≤ 20MHz:2mVpp-10Vpp; >25MHz:2mVpp-5Vpp; CH2: 2mV - 3Vpp					
Modulation Type	AM,FM,PM,FSK					
Work Mode	Continue, Burst, Sweep, Modulation					
Burst Characteristics	Burst Count: 1 to 50 000 or Infinite; gated; trigger source: internal, external, manual					

Ordering Information

	Description	Order Number
Model	DG1022A (25 MHz, dual-channel)	DG1022A
	DG1022 (20MHz, dual-channel)	DG1022
Standard Accessories	BNC Cable (1 meter)	CB-BNC-BNC-MM-100
	Power Cord	-
	Quick Guide	-
Optional Accessories	USB Cable	CB-USBA-USBB-FF-150
	40dB Attenuator	RA5040K
	10W Power Amplifier	PA1011
	BNC to Alligator Clamp	CB-BNC-AC-100-L

Digital Multimeter



DM3000 series Digital multimeters (DM3068, DM3058, DM3058E) are the products designed with multi-functions, high-precision, high performance and automatic measurements, they are integrated with the features of high-speed data acquisition, high precision, high stability, support any type of sensors, complete interfaces.

They have complete interface such as RS-232, USB, LAN (LXI-C) and GPIB, they support the U disk storage. It's easy to be

connected to the PC by the USB or LAN. They have been optimized for the production line automatic measurements with the PASS/FAIL control, unified power management, pre-programmed configurations, configuration setup cloning, fast measurement speed and noise immunity to improve the productivity. DM3000 series Digital multimeters are widely used in the areas of Research, Production line tests, Education, Quality Assurance, Service/ Maintenance, etc.

- 6 ½ (DM3068) or 5 ½ (DM3058/E) digits readings resolution
- Max. 10A Current Measurement Range
- Dual Measurements Display
- Support temperature sensors (TC, RTD and THERM) and user defined sensor
- Statistical analysis; Real-time Trend and Histogram display functions (DM3068)
- Abundant interfaces; Command compatible with main stream DMMs

Real 6½ digits readings resolution (DM3068)

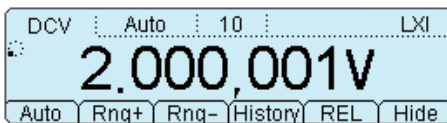

Easy to measure AC signal with double display

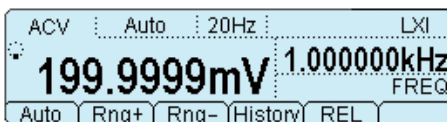

Standard Capacitor measurement function

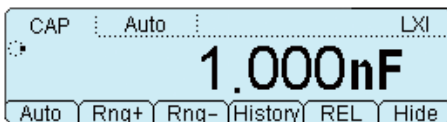

“Any sensor” function

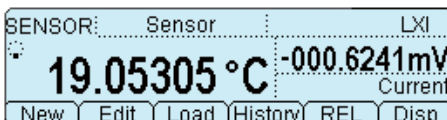

Support multiple temperature sensors

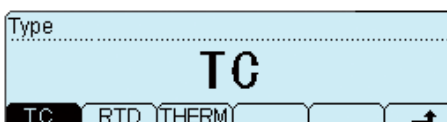

Support multiple commands

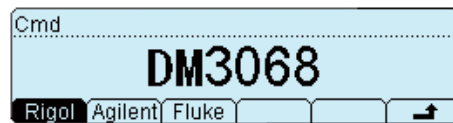

Trend display

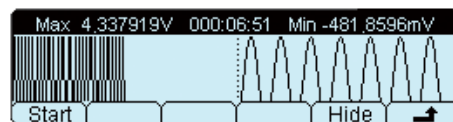

Histogram display



Pass/Fail test



Clone all configurations from one instrument to another

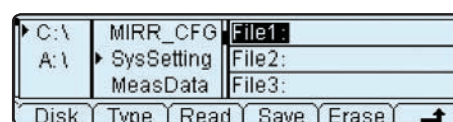

Key Specifications

Function	Range	1Year Accuracy Specifications ± (% of reading + % of range) (Tcal 23°C ±5°C)	
		DM3068	DM3058/E
DC Voltage	200.000mV ~ 1000.00V	0.0035 + 0.0006	0.015 + 0.003
DC Current	200.000uA ~ 10.0000A	0.030 + 0.003	0.055 + 0.005
AC Voltage (RMS)	200.000mV ~ 750.000V	0.06 + 0.04	0.2 + 0.05
AC Current (RMS)	200.0000uA ~ 10.00000A ^[1]	0.10 + 0.04	0.30+ 0.10
Resistance	200.000Ω ~ 100.000MΩ	0.010 + 0.001	0.020 + 0.003
Diode Test	2.000V/1mA	0.010 + 0.020	0.05 + 0.01
Continuity Test	2000.0Ω/1mA	0.010 + 0.020	0.05 + 0.01
Period/Frequency	3Hz-1MHz (200mV ~750V)	0.007	0.01+ 0.003
Capacitance	2.000nF ~ 100.0mF ^[2]	1 + 0.3	1+0.5
Max. Reading Speed		10000 rdgs /s	123 rdgs /s
Volatile Memory		512k readings of history records	2000 readings of history records
Remote Command		RIGOL, Agilent, FLUKE	

[1] DM3058/E ACI range: 20mA to 10A

[2] DM3058/E Cap range: 2nF to 10uF

Ordering Information

	Description	Order Number
Model	DM3068: 6½ digits; standard interfaces: GPIB, LAN, USB, RS232	DM3068
	DM3058: 5½ digits; standard interfaces: GPIB, LAN, USB, RS232	DM3058
	DM3058E: 5½ digits; standard interfaces: USB, RS232	DM3058E
Standard Accessories	Two Test Leads (black and red)	LD-DM
	Two Alligator Clips (black and red)	ALLIGATORCLIP - DMM
	USB Cable	CB-USBA-USBB-FF-150
	Spare Fuses (DM3068: four; DM3058/E: two)	-
	Power Cord	-
	Quick Guide	-
Optional Accessories	Kelvin Test Clips	KELVINTTESTCLIP - DMM
	RS232 cable	-
	Rack Mount Kit	RM-DM3000

Data Acquisition/ Switch System



M300 Series Data Acquisition/Switch System with modular structure, which combines precision measurement capability with flexible signal connections, can provide versatile solutions for the applications with multiple points or signals to be tested in product performance test during R&D phase as well as automatic test during production process.

- 4.3' TFT LCD, easy for operation
- 6½ digit DMM can be inserted into any slot. supporting multiple measurement functions, including DCV,DCI, ACV, ACI, 2WR, 4WR, PERIOD, FREQ, TEMP and any sensor
- Up to 320 switch channels per mainframe, save on cost of ownership
- 8 kinds of Modules supported
- Full Interfaces supported: USB Device, USB Host, GPIB, LAN(LXI-C), RS232
- Powerful PC software

Measurement Configuration



Draw real-time scan data curves

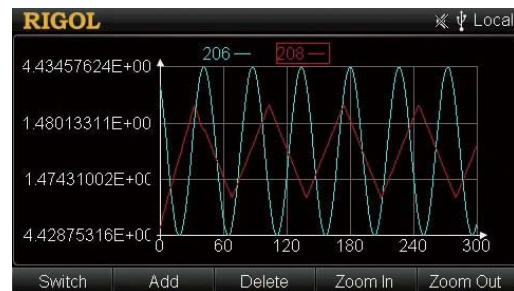

Single Channel Monitor



MC3648 Control Interface



Display real-time scan information and all the measurement data



MC3534 Control Interface

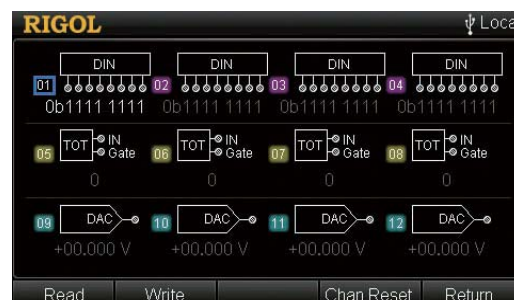

Key Specifications

Module	Terminal Box	Channels				Description
		20	24	32	64	
MC3065	-					DMM module, 6½ digits, support functions: DCV, ACV, DCI, ACI, 2WR, 4WR, FREQ, PERIOD, TEMP and any sensor
MC3120	TB20	●				20-channel HI/LO (differential) input, Support 4-wire measurement
MC3132	TB32			●		32-channel HI/LO (differential) input, Support 4-wire measurement
MC3164	TB64				●	64-channel (single-ended), switch HI input only
MC3324	TB24		●			Mix multiplexer with 20 voltage channels and 4 current channels
MC3416	TB16					16-channel actuator that can connect signal to the device under test or enable external device
MC3534	TB34					Multifunction module. ·DIO: four 8-bit digital input/output ports ·TOT: four totalizer input terminals ·DAC: four analog output terminals
MC3648	TB48					4×8 two-wire matrix switch

Ordering Information

	Description	Order Number
Mainframe	M300: Data Acquisition/Switch System	M300
	M301: Data Acquisition/Switch System + DMM Module	M301
	M302: Data Acquisition/Switch System + DMM Module+MC3120+M3TB20	M302
Module	DMM Module (6½ digits)	MC3065
	20-channel Multiplexer	MC3120
	32-channel Multiplexer	MC3132
	64-channel Single-ended Multiplexer	MC3164
	20-voltage-channel+4-current-channel Mixed Multiplexer	MC3324
	16-channel Actuator	MC3416
	Multifunction Module	MC3534
	4×8 Matrix Switch	MC3648
Terminal Box	MC3120 Terminal Box	M3TB20
	MC3324 Terminal Box	M3TB24
	MC3648 Terminal Box	M3TB48
	MC3534 Terminal Box	M3TB34
	MC3416 Terminal Box	M3TB16
	MC3132 Terminal Box	M3TB32
	MC3164 Terminal Box	M3TB64
Standard Accessories	USB Cable	CB-USBA-USBB-FF-150
	Mixed-interface Separator Line	MIX-SEPARATOR
	Power Cord, Quick Guide	-
	Spare Fuses	-
Optional Accessories	RS232 Cable	CB-DB9-DB9-FF-150
	GPIB Reverse Entry for M300	M3GPIB
	External Port for Analog Bus Interface	M3A2B
	Rack Mount Kit	RM-1-M300
	Rack Mount Kit for Two Instruments	RM-2-M300
	M300 Series control and advanced data analysis PC Software	UltraAquire Pro

Programmable DC Power Supply



DP800 and DP700 Series are high-performance programmable linear DC power supply. All models of DP800 series have excellent features including standard timing outputs, extremely low ripple and noise, comprehensive over-voltage, over current, over-temperature protection, a large and clear user interface, super performance and specifications. DP800A models provide standard high resolution mode (1mV/1mA), fully remote control interfaces, On-line Monitoring and analysis functions; those functions are the options for DP800 models.

DP700 series power supply is a type of affordable programmable linear DC power supply with high performance. DP700 series also supports timing output and trigger function, and provides a remote control interface, the clear and simple user interface make it easy to use for the customers.

DP800 Series and DP700 Series have broad range of applications such as:

- Power supply for the R&D labs
- System integration
- Provide clean power for RF products
- Verification and characterisation for the device or circuit
- Teaching labs

Model	Outputs	Output Range	Max. Power	Ripple & Noise	Std. Programming resolution	High resolution option	Monitor	Analyzer	Timing Output	Digital IO	Synchronized Output	RS232	LAN
DP711	1	30V/5A	150W	<500 μ Vrms	10mV	○			○		○	●	
DP712	1	50V/3A	150W	<500 μ Vrms	10mV	○			○		○	●	
DP811	1	20V/10A or 40V/5A	200W	<350 μ Vrms	10mV	○	○	○	●	○		○	○
DP821	2	8V/10A 60V/1A	140W	<350 μ Vrms	10mV/10mV	○	○	○	●	○		○	○
DP832	3	30V/3A 30V/3A, 5V/3A	195W	<350 μ Vrms	10mV/10mV/10mV	○	○	○	●	○		○	○
DP831	3	8V/5A 30V/2A, -30V/2A	160W	<350 μ Vrms	1mV/10mV/10mV	○	○	○	●	○		○	○
DP811A	1	20V/10A or 40V/5A	200W	<350 μ Vrms	1mV	●	●	●	●	●		●	●
DP821A	2	8V/10A 60V/1A	140W	<350 μ Vrms	1mV/1mV	●	●	●	●	●		●	●
DP832A	3	30V/3A 30V/3A, 5V/3A	195W	<350 μ Vrms	1mV/1mV/1mV	●	●	●	●	●		●	●
DP831A	3	8V/5A 30V/2A, -30V/2A	160W	<350 μ Vrms	1mV/1mV/1mV	●	●	●	●	●		●	●

● Standard ○ Optional

DP800 Series Programmable Linear DC Power Supply



DP800 Series is the high-performance programmable linear DC power supply. All models have excellent features including standard timing outputs, extremely low ripple and noise, comprehensive over-voltage, over current, over-temperature protection, a large and clear user interface, super performance and specifications. DP800A models provide standard high resolution mode (1mV/1mA), fully remote control interfaces, on-line Monitoring and analysis functions; those functions are the options for DP800 models.

- 1, 2 or 3 outputs, the maximum power is up to 195W
- Low Ripple and Noise: <math><350\mu\text{Vrms}/2\text{mVpp}</math>
- Fast Transient Response Time: <math><50\mu\text{s}</math>
- 0.01% Linear Regulation Rate and Load Regulation Rate
- Standard Timing output; Built-in V,A,W measurements and waveform display
- 3.5 inch TFT display, easy for operation

Intuitive User Interface

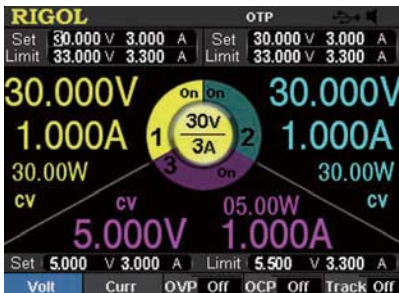

Output On/Off Delay

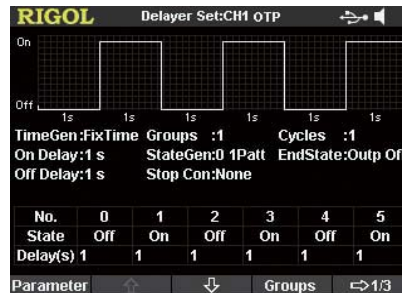

Output Analysis

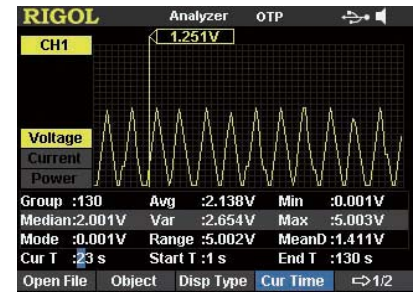

Timing Output Setting

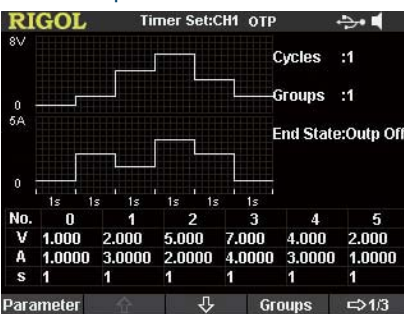

V/A/W Waveform Display

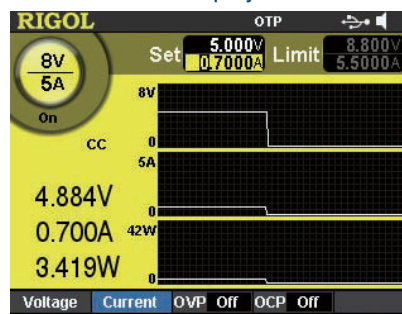

LAN Setting

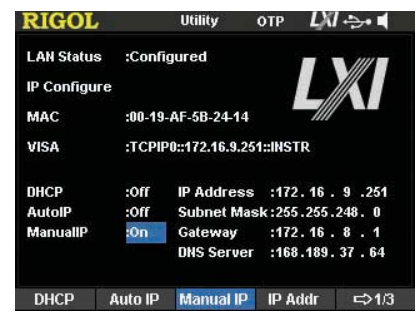

Key Specifications

Model	DP832A	DP832	DP831A	DP831	DP821A	DP821	DP811A	DP811
Channels	3			2		1		
DC Output	30V/3A 30V/3A, 5V/3A		8V/5A 30V/2A, -30V/2A		8V/10A 60V/1A		20V/10A or 40V/5A	
Load Regulation Rate	Voltage: <math><0.01\% + 2\text{mV}</math>; Current: <math><0.01\% + 250\mu\text{A}</math>							
Linear Regulation Rate	Voltage: <math><0.01\% + 2\text{mV}</math>; Current: <math><0.01\% + 250\mu\text{A}</math>							
Ripples and Noise(20Hz-20MHz)	Normal Mode Voltage: <math><350\mu\text{Vrms}/3\text{mVpp}</math>; Normal Mode Current: <math><2\text{mArms}</math>							

Programming Annual Accuracy	Voltage	CH1	0.05% + 20mV	0.1%+5mV	0.1%+25mV	0.05%+10mV			
		CH2	0.05% + 20mV	0.05%+20mV	0.05%+10mV	-			
		CH3	0.1% + 5mV	0.05%+20mV	-	-			
	Current	CH1	0.2% + 5mA	0.2%+10mA	0.2%+10mA	0.1%+10mA			
		CH2	0.2% + 5mA	0.2%+5mA	0.2%+10mA	-			
		CH3	0.2% + 5mA	0.2%+5mA	-	-			
Readback Annual Accuracy	Voltage	CH1	0.05% + 20mV	0.1%+5mV	0.1%+25mV	0.05%+10mV			
		CH2	0.05% + 20mV	0.05%+20mV	0.05%+10mV	-			
		CH3	0.1% + 5mV	0.05%+20mV	-	-			
	Current	CH1	0.15% + 5mA	0.2%+10mA	0.15%+10mA	0.1%+10mA			
		CH2	0.15% + 5mA	0.1%+5mA	0.15%+10mA	-			
		CH3	0.15% + 5mA	0.1%+5mA	-	-			
Programming Resolution	Voltage	1mV	10mV	1mV 1mV 1mV	1mV 10mV 10mV	10mV 1mV 10mV	10mV 10mV	1mV	10mV
	Current	1mA	1mA	0.3mA 0,1mA 0,1mA	1mA 1mA 1mA	0.1mA 1mA	1mA 10mA	0.5mA	10mA
Readback Resolution	Voltage	0.1mV	10mV	0.1mV	1mV	1mV 1mV	10mV 10mV	0.1mV	1mV
	Current	0.1mA	1mA	0.1mA	1mA	0.1mA 1mA	1mA 10mA	0.1mA	1mA
Display Resolution	Voltage	1mV	10mV	1mV	10mV	1mV 1mV	10mV 10mV	1mV	10mV
	Current	1mA	10mA	1mA	10mA	0.1mA 1mA	1mA 10mA	1mA	10mA
Interface	USB Device	●	●	●	●	●	●	●	●
	USB Host	●	●	●	●	●	●	●	●
	LAN	●	○	●	○	●	○	●	○
	RS232	●	○	●	○	●	○	●	○
	Digital IO	●	○	●	○	●	○	●	○
	USB-GPIB	○	○	○	○	○	○	○	○

Ordering Information

	Description	Order Number
Models	Three channel, high resolution, Programmable Linear DC Power Supply	DP832A
	Three channel, Programmable Linear DC Power Supply	DP832
	Three channel, two polarity ,high resolution, Programmable Linear DC Power Supply	DP831A
	Three channel, two polarity ,Programmable Linear DC Power Supply	DP831
	Two channel, high resolution, Programmable Linear DC Power Supply	DP821A
	Two channel, Programmable Linear DC Power Supply	DP821
	One channel, dual ranges, high resolution, Programmable Linear DC Power Supply	DP811A
	One channel, dual ranges, Programmable Linear DC Power Supply	DP811
Standard Accessories	USB cable	CB-USBA-USBB-FF-150
	One fuse (50T-025H 250V 2.5A)	-
	One shorted device	-
	Power cord, Quick Guide	-
Optional Accessories	1mV & 1mA High resolution option(DP8xx models)	HIRES-DP800
	4 Lines Trigger In&Out (DP8xx models)	DIGITALIO-DP800
	On-line Monitoring and analysis (DP8xx models)	AFK-DP800
	RS232 and LAN interface (DP8xx models)	INTERFACE-DP800
	USB-GPIB Converter	USB-GPIB
	Rack Mount Kit (one instrument)	RM-1-DP800
Rack Mount Kit (two instruments)	RM-2-DP800	

DP700 Series Programmable Linear DC Power Supply



DP700 series power supply is a type of affordable programmable linear DC power supply with high performance. DP700 series supports timing output and trigger function, and provides a remote control interface, the clear and simple user interface make it easy to use for the customers.

- Two Models, Single Output, Max. Output Power up to 150 W
- Low ripple and noise: <math><500\mu\text{Vrms}/3\text{mVpp}</math> or 4mVpp
- 0.01% Excellent load and line regulation rate
- Support 1 mV/1 mA high resolution mode
- Complete OV,OT,OC protection function
- Synchronous output for multiple units
- Timing output
- 3.5-inch TFT-LCD; compact size, easy to use

Complete overvoltage/overcurrent protection (OVP/OCP)

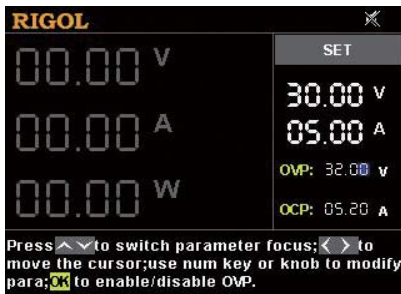

Convenient trigger function

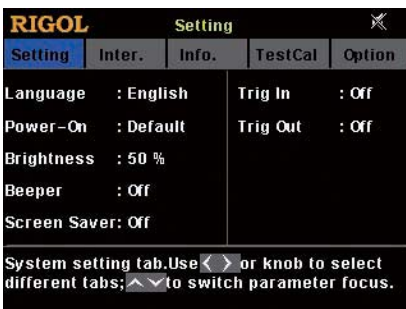

Clear and intuitive user interface, easy to use

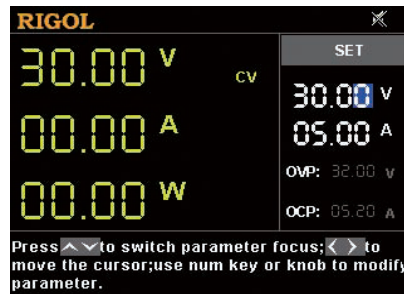

Easy-to-use function of file storage and recall

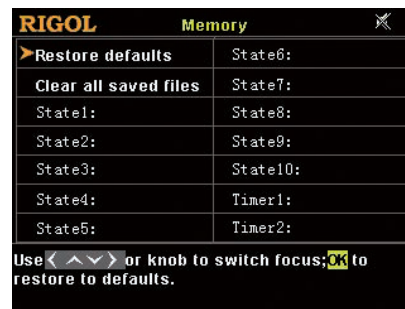

Powerful timing output function

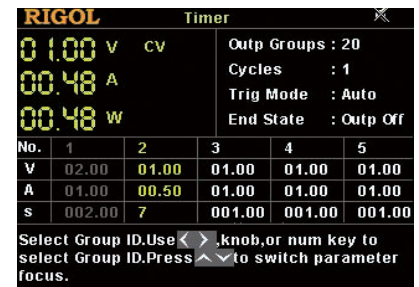

Abundant system setting function

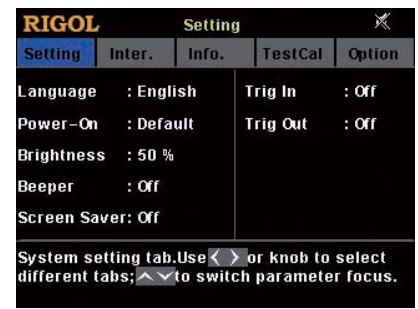

Key Specifications

Model	Voltage/Current Rating	OVP/OCP
DP711	0 V to 30 V/0 A to 5 A	0.01 V to 33 V/0.01 A to 5.5 A
DP712	0 V to 50 V/0 A to 3 A	0.01 V to 55 V/0.01 A to 3.3 A
Load Regulation, \pm(% of Output + Offset)		
Voltage	<math><0.01\% + 2\text{ mV}</math>	
Current	<math><0.01\% + 2\text{ mA}</math>	
Line Regulation, \pm(% of Output + Offset)		
Voltage	<math><0.01\% + 2\text{ mV}</math>	
Current	<math><0.01\% + 2\text{ mA}</math>	

Ripple and Noise (20 Hz to 20 MHz)		
Model	Normal Mode Voltage	Normal Mode Current
DP711	<500 μ Vrms/3 mVpp	<2 mArms
DP712	<500 μ Vrms/4 mVpp	
Annual Accuracy^[1] (25°C \pm 5°C), \pm(% of Output + Offset)		
Programming	Voltage	0.05% + 20 mV
	Current	0.2% + 10 mA
Readback	Voltage	0.05% + 20 mV
	Current	0.2% + 20 mA
Resolution		
Programming	Voltage	Standard: 10 mV High resolution option installed: 1 mV
	Current	Standard: 10 mA High resolution option installed: 1 mA
Readback	Voltage	Standard: 10 mV High resolution option installed: 1 mV
	Current	Standard: 10 mA High resolution option installed: 1 mA
Display	Voltage	Standard: 10 mV High resolution option installed: 1 mV
	Current	Standard: 10 mA High resolution option installed: 1 mA
Transient Response Time		
Less than 50 μ s for output voltage to recover to within 15 mV following a change in output current from full load to half load (or from half load to full load).		
Mechanical		
Dimensions	140 mm (W) x 202mm (H) x 332 mm (D)	
Weight	Net weight: 6.9 kg	
Interface		
RS232	1	

Ordering Information

	Description	Order No.
Model	Programmable Linear DC Power Supply (single channel, 30V/5A)	DP711
	Programmable Linear DC Power Supply (single channel, 50V/3A)	DP712
Standard Accessories	Power Cord	-
	Either one of the following specified fuses: <ul style="list-style-type: none"> ● Fuse 50T-050H 250V 5A (AC Selector: 100 Vac or 120 Vac) ● Fuse 50T-025H 250V 2.5A (AC Selector: 220 Vac or 240 Vac) 	-
	Quick Guide (hard copy)	-
Optional Accessories	High Resolution	HIRES-DP700
	Trigger (external synchronous trigger input and output)	TRIGGER-DP700
	Timer	TIMER-DP700
	9-Pin RS232 Cable (female-to-female, straight)	CB-DB9-DB9-F-F-150
	DP700 Series Rack Mount Kit (for a single instrument)	RM-1-DP700
	DP700 Series Rack Mount Kit (for two instruments)	RM-2-DP700
DP700 Series Rack Mount Kit (for three instruments)	RM-3-DP700	

Programmable DC Electronic Load



DL3000 is a cost-effective programmable DC electronic load with high performance. With a user-friendly interface and superb performance specifications, DL3000 series provides various interfaces for remote communication to meet your diversified test requirements. It can be widely used in various industries.

- 150V/40A,200W;150V/60A,350W
- Dynamic mode: up to 30 kHz
- Adjustable current slew rate: 0.001 A/μs to 5 A/μs
- Min. readback resolution: 0.1 mV, 0.1 mA
- USB-GPIB interface converter (optional)

30 kHz dynamic mode

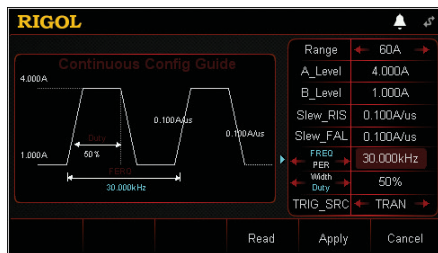

5 A/μs current slew rate

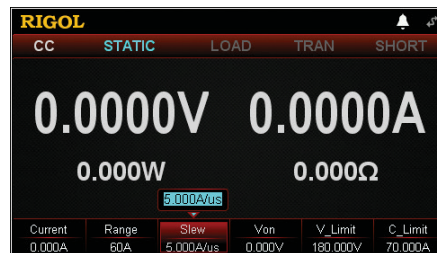

Powerful waveform display function

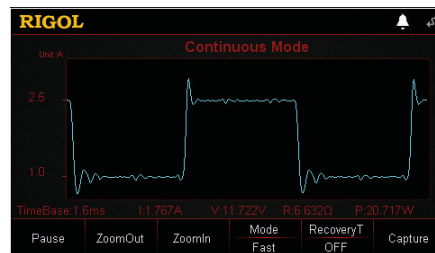

Key Specifications

Func and Spec	DL3021		DL3021A		DL3031		DL3031A	
	Low Range	High Range	Low Range	High Range	Low Range	High Range	Low Range	High Range
Power	200W				350W			
Voltage	0~150V							
Current	0~40A				0~60A			
Type Min. Operation, Voltage(DC)	40A@1V				60A@1.3V			
CC Mode								
Range	0~4A	0~40A	0~4A	0~40A	0~6A	0~60A	0~6A	0~60A
Resolution	1mA							
Accuracy	±(0.05%+0.05%FS)							
Temperature Coefficient	100ppm/°C							
CV Mode								
Range	0~15V	0~150V	0~15V	0~150V	0~15V	0~150V	0~15V	0~150V
Resolution	1mV	5mV	1mV	5mV	1mV	5mV	1mV	5mV
Accuracy	±(0.05%+0.02%FS)	±(0.05%+0.025%FS)	±(0.05%+0.02%FS)	±(0.05%+0.025%FS)	±(0.05%+0.02%FS)	±(0.05%+0.025%FS)	±(0.05%+0.02%FS)	±(0.05%+0.025%FS)
Temperature Coefficient	50ppm/°C							
CR Mode								
Range	0.08Ω ~ 15Ω	2Ω ~ 15kΩ	0.08Ω ~ 15Ω	2Ω ~ 15kΩ	0.08Ω ~ 15Ω	2Ω ~ 15kΩ	0.08Ω ~ 15Ω	2Ω ~ 15kΩ
Resolution	2mA/Vsense							
Accuracy	Vin/Rset*(0.2%)+0.2% IFS							

CP Mode								
Range	0~200W				0~350W			
Resolution	100mW							
CC Continuous Mode								
Freq Range	0.001Hz~15kHz		0.001Hz~30kHz		0.001Hz~15kHz		0.001Hz~30kHz	
Freq Accuracy	0.8%							
Freq Resolution	±0.5%							
Duty Cycle Range	5%~95%, 1%							
Slew Rate								
CC SlewRate	0.001A/ μs~0.25A/μs	0.001A/μs ~ 2.5A/μs(>5V)	0.001A/ μs~0.3A/μs	0.001A/μs ~ 3A/μs(>5V)	0.001A/ μs~0.25A/μs	0.001A/μs ~ 2.5A/μs(>5V)	0.001A/ μs~0.5A/μs	0.001A/ μs~5A/ μs(>5V)
SlewRate Resolution	0.001A/μs							
Accuracy	5% +10μs							
Current ReadBack								
Range	0~40A				0~60A			
Resolution	1mA		0.1mA		1mA		0.1mA	
Accuracy	±(0.05%+0.05%FS)							
Temperature Coefficient	50ppm/°C							
Voltage ReadBack								
Range	0~150V							
Resolution	0.1mV							
Accuracy	±(0.05%+0.02%FS)							
Temperature Coefficient	20ppm/°C							
Protection Function	Overcurrent protection (OCP), overvoltage protection (OVP), overpower protection (OPP), overtemperature protection (OTP), as well as local/remote reverse voltage (LRV/RRV) protection.							
DRIFT STABILITY								
Current	±(0.01%±10mA)							
Voltage	±(0.01%±10mV)							
Input Resistance	350kΩ							
Interface								
USB DEVICE	●		●		●		●	
USB HOST	●		●		●		●	
RS232	●		●		●		●	
LAN	○		●		○		●	
Digital I/O	○		●		○		●	
GPIB	○		○		○		○	

Ordering Information

	Description	Order No.
Model	Programmable DC Electronic Load (single channel, DC 150 V/40 A 200 W 15kHz 2.5A/us)	DL3021
	Programmable DC Electronic Load (single channel, DC 150 V/40 A 200 W 30kHz 3.0A/us)	DL3021A
	Programmable DC Electronic Load (single channel, DC 150 V/60 A 350 W 15kHz 2.5A/us)	DL3031
	Programmable DC Electronic Load (single channel, DC 150 V/60 A 350 W 30kHz 5.0A/us)	DL3031A
Optional Accessories	LAN Interface	LAN-DL3
	Digital I/O Option	DIGITALIO-DL3
	High Readback Resolution	HIRES-DL3
	High Frequency Option	FREQ-DL3
	High Slew Rate Option	SLEWRATE-DL3
	Terminal Shield	DL-02
	9-Pin RS232 Cable (female-to-female, cross-over)	CB-RS232-A
	USB-GPIB interface converter	USB-GPIB-L
	Sense Cable	CB-SENSE
	20 A Red and Black Test Lead	CB-20A-780MM
40 A Red and Black Test Lead	CB-40A-780MM	
60 A Red and Black Test Lead	CB-60A-780MM	

Distribution in the UK & Ireland



Lambda Photometrics Limited

Lambda House Batford Mill
Harpenden Herts AL5 5BZ
United Kingdom

E: info@lambdaphoto.co.uk

W: www.lambdaphoto.co.uk

T: +44 (0)1582 764334

F: +44 (0)1582 712084

RIGOL® is the registered trademark of **RIGOL** Technologies, Inc. Product information in this document subject to update without notice. For the latest information about **RIGOL**'s products, applications and services, please contact local **RIGOL** office or access **RIGOL** official website: www.rigol.com