

With Near Field Scanners you will discover a new and powerful way to “see” EMI!

Arturo Mediano - July, 2020

Y.I.C. Technical Advisor · Professor University of Zaragoza

As you know from some of my previous publications, I love near field probes.

They are very useful to "see" magnetic and electric fields in time domain (scope) or frequency domain (scope with FFT or spectrum analyzer).

When interested in electric fields, a small tip is used to capture electric field lines. Remember that electric field lines will be related with dv/dt in your circuits.

When interested in magnetic fields, a small loop is built to pick-up magnetic field lines around the area of interest in your circuit. The output of the probe is related with di/dt in your components, traces or wires.

The most typical way to use near field probes is to locate the probe on top of the area of interest looking for high activity at some specific frequency but the probes can be used too for injecting EMI in a susceptible circuit. Big and very small loops and tips are available for high sensitivity or precise analysis up to the pin level.

For example, you can use near field probes to scan your PCBs, your cables and your enclosures as in Figure 1.

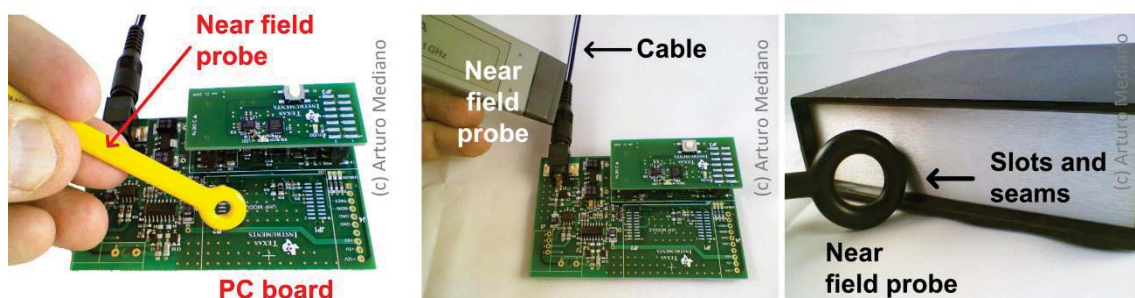

Fig. 1 Typical uses for near field probes.

In this way, a critical layout, a radiating cable or a dangerous slot can be easily located and solutions can be evaluated in a very effective and useful way.

Distribution in the UK & Ireland



**Characterisation,
Measurement &
Analysis**

Lambda Photometrics Limited
Lambda House Batford Mill
Harpenden Herts AL5 5BZ
United Kingdom
E: info@lambdaphoto.co.uk
W: www.lambdaphoto.co.uk
T: +44 (0)1582 764334
F: +44 (0)1582 712084

In the past years, I have enjoyed with the opportunity of using the scanners from Y.I.C. Technologies: EMScan and EMProbe (Fig. 2). A scanner tries to do the job of near field probes in a professional, repetitive, and fast way.

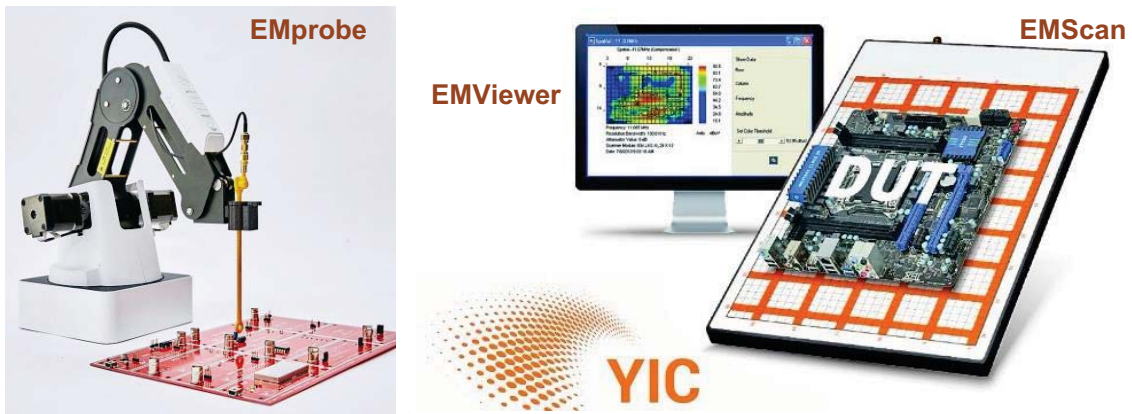

Fig. 2. EMProbe (left) and EMScan (right) from Y.I.C. Technologies.

With EMProbe you have one probe to diagnose EMC/EMI problems using regular off the shelf hand-held probes. An easy to use Robotic Arm controls the movement of the probe to any direction and an external Spectrum Analyzer provides the results.

EMScan is a flat surface with thousands of loops spaced several millimeters in a way to provide effective resolution in the order of millimeter. Frequency range goes from 150 kHz to 8 GHz depending of models.

The loop antennas are sensitive down to -135 dBm and a high-speed electronic switching system provides real-time real-fast (<1s) analysis for magnetic near field emissions from the DUT.

For both scanners, the EMViewer software is used to control the Robotic Arm and the external Spectrum Analyser collecting and analysing the results.

As an example in Fig. 3 you can see a picture of the scanner (scan area 21.8cm x 31.6cm) with a PCB being tested.

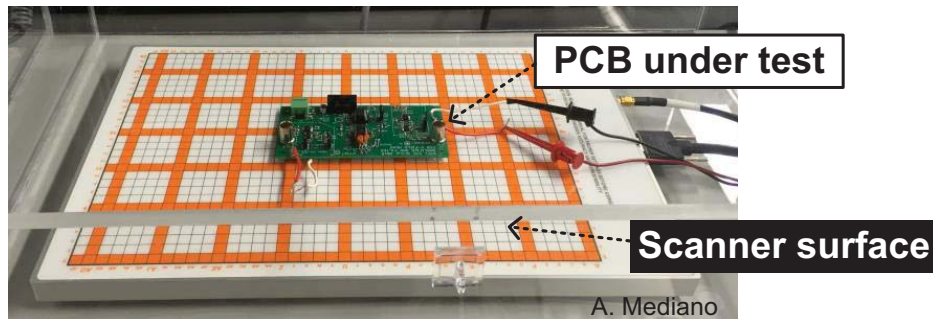

Fig. 3. A PCB under test on top of the near field scanner.

The magnetic field measurement is related with current in the scanned device and spectral and real time spatial scan images can be captured and displayed in seconds.

I like this approach to immediately analyze and compare design iterations, optimize design of hardware, for troubleshooting, and for teaching purposes. The results are really impressive.

Consider for example a typical circuit with a 24MHz digital IC clock including a decoupling circuit for the IC as shown in Fig. 4.

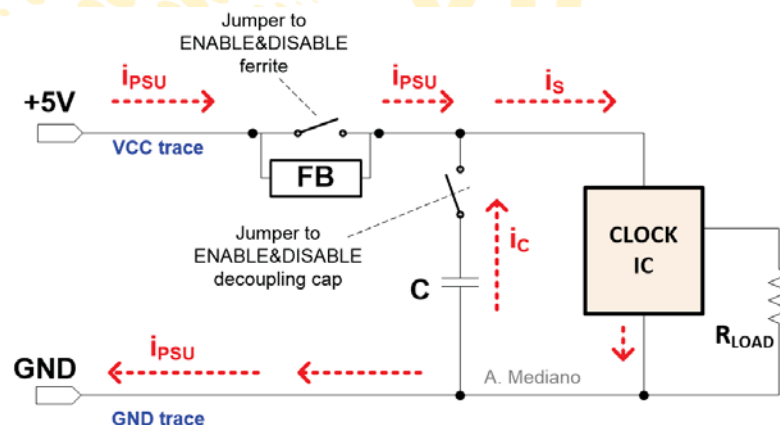

Fig. 4. Basic schematic for the decoupling network of the IC clock.

Power supply (+5V) comes from an USB connector including a SMD fuse, a small led for visual feedback and a couple of capacitors for board decoupling. Load for the clock is a 50ohm resistor.

A transient current (i_s) is required from power supply for IC operation and usually the high frequency content of that current (harmonics) is the origin of many EMI conducted and radiated problems.

To minimize problems, a decoupling network (usually SMD capacitors and ferrites) is used to avoid those high frequency components going through the power supply system. If the decoupling circuit is working as expected, current i_{PSU} will be reduced to DC and transients take the path from the decoupling capacitor (i_C). With two jumpers we can enable/disable the decoupling network so the effectiveness of the network can be evaluated.

In Fig. 5 we can see the top view of the board. Note VCC trace is on top layer. GND trace (no ground plane) is in bottom layer.

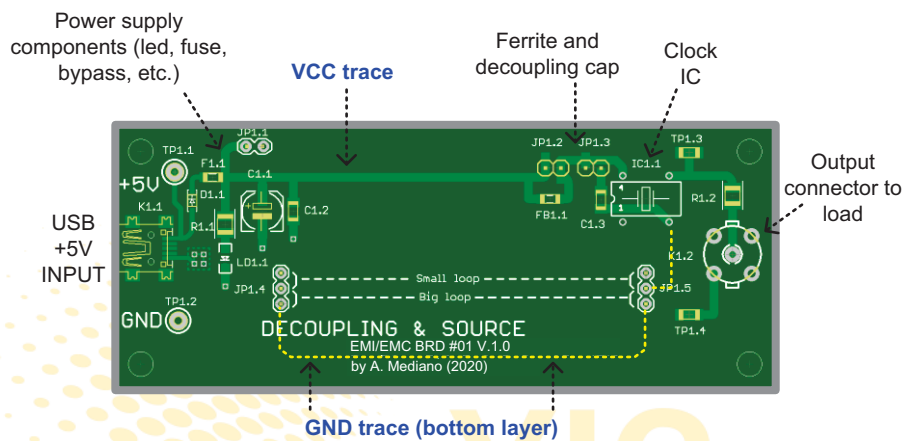

Fig. 5. General view of PCB for our decoupling example.

Doing a spectral scan, we can identify signals from the board. Sometimes those signals come from oscillators and clocks (harmonics). Sometimes those signals are parasitic oscillations or ringing more difficult to prevent. With the spectral scan we can measure any signal from the board.

In Fig. 6 we see one measurement of spectral scan where we can identify the harmonics of the 24MHz clock transient currents and some EMI from the environment including FM broadcasting signals (88-108MHz).

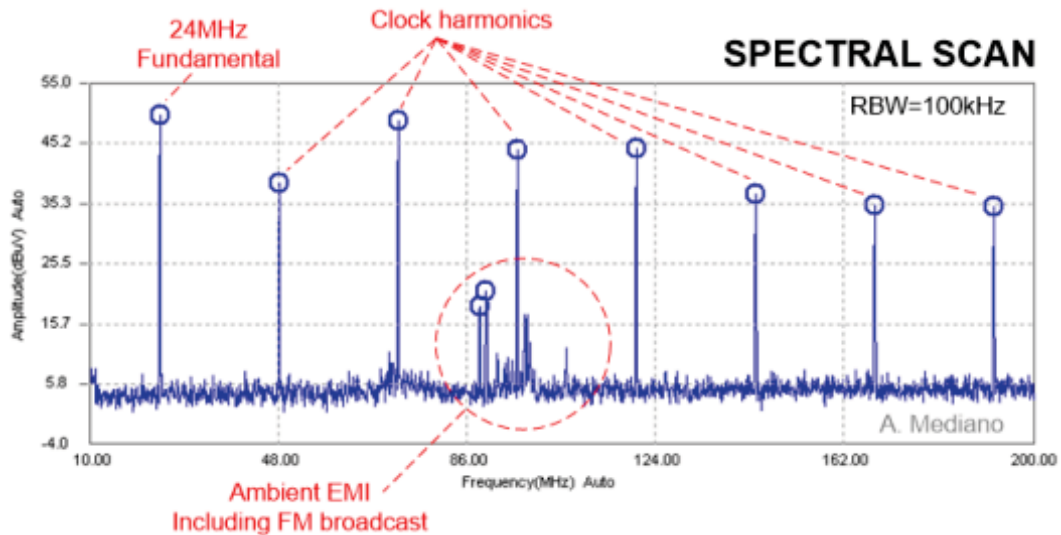

Fig. 6. Spectral scan where emissions from the PCB are clearly identified.

With a spectral and spatial scan we can identify the current path for that signals, critical information if you want to minimize EMI/EMC and SI problems.

Note in Fig. 7 the big loop for that current when no decoupling capacitor and ferrite are enabled.

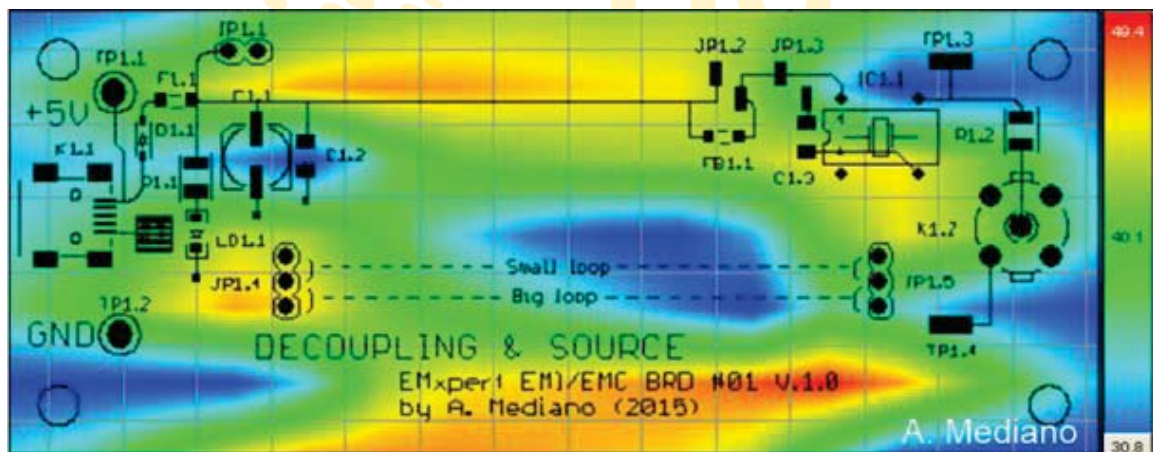

Fig. 7. Spectral and spatial scan without decoupling network where the path for current is clearly identified in a big loop (maximum levels are read as dBuV in red color).

The big loop can create distortion for the clock signal, radiated emissions for high frequency harmonics, crosstalk with other boards or cables, and injected noise in the power supply or cables.

When the decoupling network is enabled, the loop is reduced (transients take the path of the decoupling capacitor) and EMI currents are contained in the area closer to the clock IC (see Fig. 8).

Note maximum levels in red color are now more than 16dB below the previous measurement (with the same scale this new plot would be basically blue).

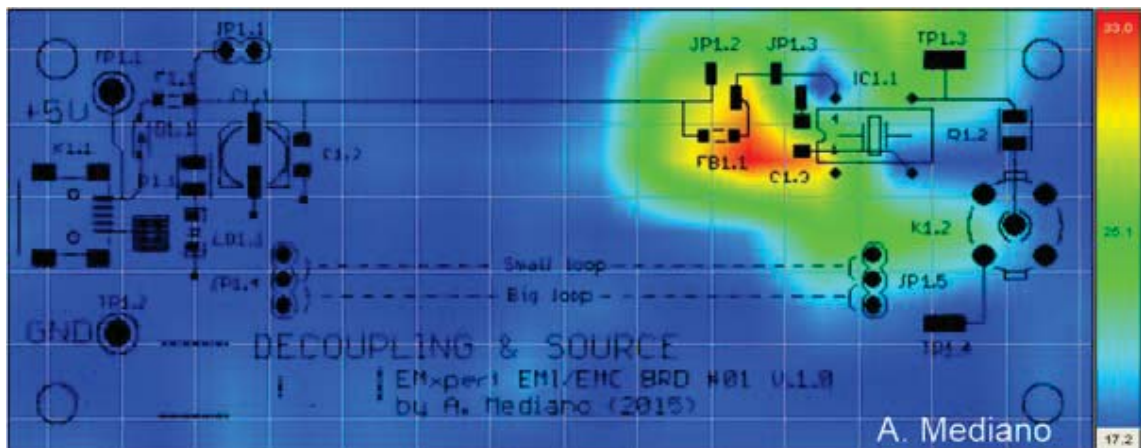

Fig. 8. Spectral and spatial scan with decoupling circuit enabled.

A typical question when doing the review of a product is:

“Have you decoupling capacitor?”.

Usually response is something like:

“Of course, I have a 100nF capacitor!”.

Sometimes, you have a capacitor (or decoupling circuit) in your system but there is no effective decoupling because terminal impedances do not match the topology you have chosen, the capacitor technology/value is not correct or parasitic effects in the layout and package are dominant. With a near field scan, you can detect how your decoupling system is really working.

Any tool useful to see signals is so powerful!

Distribution in the UK & Ireland



Lambda Photometrics Limited
Lambda House Batford Mill
Harpenden Herts AL5 5BZ
United Kingdom
E: info@lambdaphoto.co.uk
W: www.lambdaphoto.co.uk
T: +44 (0)1582 764334
F: +44 (0)1582 712084